

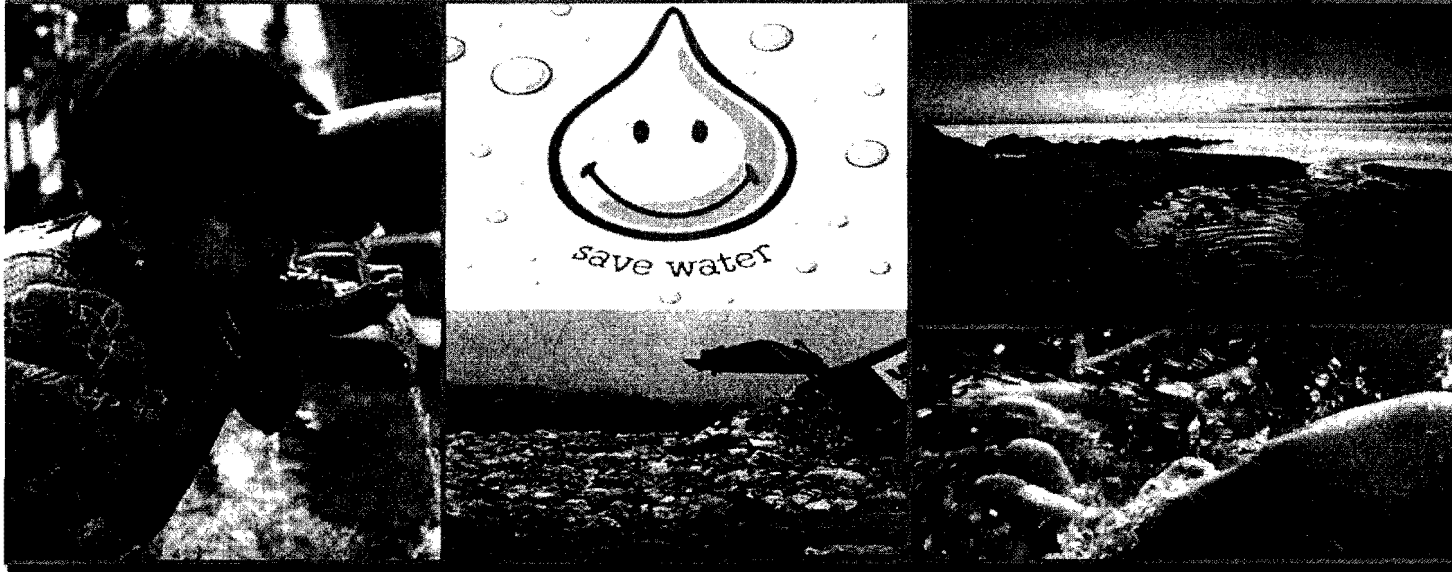

# Environmental Assessment and Environmental Management Framework for Jalanidhi-2



Study Conducted by



**ABC ENVIRON SOLUTIONS Pvt. Ltd.,**

(AN ISO 9001, ISO 14001 & OHSAS 18001 CERTIFIED COMPANY)  
No. 2, II Street, Thangam Colony, Annanagar West, Chennai 600040. INDIA  
Ph: +91-44-26161123 / 24 / 25; Fax: +91-44- 26163456  
e-mail: abc@abcenviron.com | www.abcenviron.com  
Helpline: +91 - 94442 60000

July 2011

## TABLE OF CONTENTS

LIST OF ACRONYMS.....	i
EXECUTIVE SUMMARY.....	a
1. INTRODUCTION.....	1
1.1 BACKGROUND .....	1
1.2 KERALA RURAL WATER SUPPLY AND SANITATION AGENCY (KRWSA)...	1
1.3 JALANIDHI - 1 .....	2
1.3.1 LESSONS LEARNT AND REFLECTED IN THE JALANIDHI - 2 PROJECT DESIGN.....	2
1.4 PROPOSED WORLD BANK AIDED JALANIDHI 2 - OBJECTIVES .....	3
1.5 TECHNICAL ASPECTS OF JALANIDHI - 2.....	3
1.5.1 COMPONENTS .....	3
1.5.2 WATER DEVELOPMENT PLANS.....	5
1.5.3 TECHNICAL MANUAL .....	5
1.5.4 DETAILED PROJECT REPORTS .....	6
1.5.5 RESPONSIBILITY MATRIX FOR ENGINEERING ACTIVITIES.....	6
1.5.6 QUALITY ASSURANCE .....	6
1.6 RATIONALE FOR ENVIRONMENT ASSESSMENT / ENVIRONMENT MANAGEMENT FRAMEWORK .....	7
1.6.1 ENVIRONMENTAL ISSUES .....	7
1.7 APPROACH AND METHODOLOGY FOR EA/EMF .....	8
1.7.1 SITE VISITS.....	8
1.7.2 FOCUSED GROUP DISCUSSIONS.....	8
1.7.3 DESK STUDY .....	10
1.8 REPORT STRUCTURE.....	11
2. RURAL WATER SUPPLY AND SANITATION IN KERALA - POLICY, REGULATORY FRAMEWORK AND PROGRAMME .....	12
2.1 NATIONAL CONTEXT OF RWSS SECTOR .....	12
2.2 GOVERNMENT OF INDIA PROGRAMMES - NATIONAL & STATE .....	12
2.2.1 ACCELERATED RURAL WATER SUPPLY PROGRAMME (ARWSP) ....	13
2.2.2 TOTAL SANITATION CAMPAIGN .....	14
2.2.3 SECTOR REFORM .....	15



2.2.4	SWAJALDHARA .....	16
2.3	RURAL WATER SUPPLY & SANITATION COVERAGE IN KERALA.....	17
2.3.1	DRINKING WATER SUPPLY COVERAGE.....	17
2.3.2	STATUS OF WATER SUPPLY COVERAGE IN HABITATS.....	19
2.3.3	WATER SUPPLY SCHEMES IN OPERATION .....	20
2.3.4	SANITATION .....	24
2.4	REGULATORY AND POLICY FRAMEWORK.....	27
2.4.1	NATIONAL FRAMEWORK.....	30
2.4.2	STATE FRAMEWORK .....	34
2.5	SECTOR INSTITUTIONS .....	38
2.5.1	DEPARTMENT OF WATER RESOURCES.....	38
2.5.2	KERALA RURAL WATER SUPPLY AND SANITATION AGENCY.....	39
2.5.3	KERALA WATER AUTHORITY.....	39
2.5.4	KERALA STATE GROUND WATER DEPARTMENT.....	39
2.5.5	CENTRAL GROUND WATER BOARD .....	40
2.5.6	SUCHITWA MISSION .....	40
2.5.7	CWRDM.....	41
2.5.8	DEPARTMENT OF LOCAL SELF GOVERNMENT .....	42
2.5.9	KERALA STATE POLLUTION CONTROL BOARD .....	42
3.	BASELINE ENVIRONMENTAL STATUS .....	44
3.1	PHYSICAL ENVIRONMENT .....	44
3.1.1	LOCATION .....	44
3.1.2	PHYSIOGRAPHY.....	45
3.1.3	RIVERS OF KERALA .....	46
3.1.4	SOIL PROFILE OF KERALA .....	48
3.1.5	CLIMATE AND RAINFALL.....	50
3.2	WATER RESOURCES ENVIRONMENT .....	51
3.2.1	SURFACE WATER RESOURCES.....	51
3.2.2	GROUND WATER RESOURCES.....	57
3.2.3	WATER SCENARIO IN KERALA.....	67
3.3	SOLID WASTE GENERATION AND MANAGEMENT .....	72
3.3.1	CATEGORIES OF SOLID WASTE .....	72

3.3.2	IMPACTS.....	74
3.3.3	HEALTH PROBLEMS .....	74
3.3.4	SITE VISITS TO EXISTING FACILITIES.....	75
3.3.5	EXAMPLES OF SOLID WASTE MANAGEMENT IN KERALA.....	75
3.4	ENVIRONMENTAL SANITATION.....	77
3.5	KEY ENVIRONMENTAL ISSUES .....	81
4.	ENVIRONMENTAL MANAGEMENT FRAMEWORK.....	82
4.1	INTRODUCTION.....	82
4.2	OBJECTIVES OF EMF .....	82
4.3	LIST OF REGULATORY REQUIREMENTS APPLICABLE TO JALANIDHI- 2	83
4.3.1	WATER.....	83
4.3.2	ENVIRONMENTAL PROTECTION .....	83
4.3.3	NATURAL HABITAT CONSERVATION .....	84
4.4	LIST OF TECHNICAL GUIDELINES.....	85
4.5	CLASSIFICATION OF SCHEMES AND ENVIRONMENTAL CODES OF PRACTICES.....	85
4.6	ENVIRONMENTAL APPRAISAL AND APPROVAL .....	86
4.7	INSTITUTIONAL ARRANGEMENTS FOR ENVIRONMENTAL MANAGEMENT.....	90
4.8	ENVIRONMENTAL COMPLIANCE MONITORING DURING IMPLEMENTATION AND OPERATION & MAINTENANCE PHASES.....	92
4.9	ENVIRONMENTAL SUPERVISION, MONITORING AND EVALUATION PLAN.....	92
4.10	TRAINING AND CAPACITY BUILDING.....	94
4.10.1	TECHNICAL TRAINING FOR ENVIRONMENTAL MANAGEMENT.....	95
4.10.2	DETAILS OF TRAINING PROGRAMMES.....	95
4.11	BUDGET FOR EMF IMPLEMENTATION .....	98
4.12	SUMMARY OF EMF.....	98
	PUBLIC CONSULTATION ON 'DRAFT EA AND EMF FOR JALANIDHI-2.....	102
	BIBLIOGRAPHY .....	347
	STUDY TEAM.....	351

**LIST OF TABLES**

Table 1-1 Selected Gram Panchayats .....	9
Table 2-1 Coverage Status of Water Supply Schemes .....	13
Table 2-2 District Wise Population Covered by Water Supply Schemes .....	18
Table 2-3 Population Covered with Protected Water Supply .....	18
Table 2-4 Status of Water Supply Coverage – Habitats .....	19
Table 2-5 Habitation Wise – Quantity of Water Supply .....	19
Table 2-6 Scheme Details of Habitations.....	19
Table 2-7 Water Tariff .....	21
Table 2-8 Income from Water Charges .....	21
Table 2-9 Overall Physical Achievement of JBIC Project .....	23
Table 2-10 Tsunami Rehabilitation Programme.....	24
Table 2-11 Municipal Solid Waste Generated in Kerala .....	26
Table 2-12 Nirmal Gram Puraskar Awards to Local Governments .....	27
Table 2-13 World Bank Safeguard Policies .....	27
Table 2-14 Scope of National Environmental Regulation .....	31
Table 2-15 Scope of State Environmental Regulations.....	34
Table 3-1 Districts of Kerala - Area, Population & Headquarters.....	44
Table 3-2 District Soil Profile .....	49
Table 3-3 Water potential of the river basins of Kerala .....	51
Table 3-4 Water Quality of Rivers.....	53
Table 3-5 District Wise Net Groundwater Availability of Kerala State (In MCM) 59	
Table 3-6 District Wise break Up of Categorization of the Blocks.....	65
Table 3-7 Groundwater Quality Affected Habitations.....	68
Table 3-8 Water Quality of Wells in Kerala .....	70
Table 3-9 Sanitation coverage of the BPL families .....	80
Table 4-1 Institutional Arrangement for the Implementation of EMF .....	90
Table 4-2 District Laboratories for Water Testing with Contact Details .....	93
Table 4-3 Recommended Monitoring Plan .....	94
Table 4-4 Training Programmes.....	96
Table 4-5 Number of Training Programmes.....	97



Table 4-6 Estimated Cost of Training.....	97
Table 4-7- Budget for Environmental Management.....	98
Table 4-8 Environmental Management Framework.....	99

#### LIST OF FIGURES

Figure 1-1 Flow chart for Methodology .....	10
Figure 3-1 Location Map of Kerala with its District Boundaries .....	45
Figure 3-2 Physiography of Kerala .....	46
Figure 3-3 Rivers of Kerala.....	48
Figure 3-4 Pre-Monsoon Water Level Trend for the Period 1999-2008 .....	61
Figure 3-5 Post-Monsoon Water Level Trend for the Period 1998-2007 .....	62
Figure 3-6 Hydrograph of GWMW Tapping Phreatic Aquifer in Laterites at Edamon, Kollam District .....	62
Figure 3-7 Hydrograph of GWMW Tapping Phreatic Aquifer in Laterites at Edakkad, Kannur District .....	63
Figure 3-8 Hydrograph of GWMW Tapping Phreatic Aquifer in Laterites at Thekethukavala, Kottayam District .....	63
Figure 3-9 Hydrograph of GWMW Tapping Phreatic Aquifer in Laterites at Vayittiri, Wayanad District.....	64
Figure 3-10 Hydrograph of GWMW Tapping Phreatic Aquifer in Laterites at Palai, Kottayam District .....	64
Figure 3-11 Hydrograph of GWMW Tapping Phreatic Aquifer in Weathered Crystallines at Palakkad District.....	65
Figure 3-12 Categorization*of the Blocks.....	66
Figure 3-13 Environmental Hotspots of Groundwater Contamination .....	69
Figure 3-14 Distribution of Solid Waste from.....	73
Figure 3-15 Category Wise Distribution of Hazardous Waste .....	74
Figure 4-1 Process Flow Diagram for schemes pertaining to Low & Medium Impact Category Project.....	88
Figure 4-2- Process Flow Diagram for schemes pertaining to High Impact Category Project.....	89



**LIST OF ANNEXURE**

Annexure 1 - Sanitation in Jalanidhi-2 .....	103
Annexure 2 - Protected Areas in Kerala .....	111
Annexure 3 - District Wise Categorization of Blocks (March, 2004) .....	113
Annexure 4 - Specific Problems in Study Area.....	120
Annexure 5 - Water Test Reports.....	125
Annexure 6 - Water Borne Diseases in Kerala (2005-2009) .....	159
Annexure 7 - FGD Report.....	164
Annexure 8 - Guidelines for Sanitary Survey of Water Supply Sources.....	259
Annexure 9 -Guidelines for Identification and Selection of Water Supply Sources .....	264
Annexure 10 -Recuperation Test for Estimation of Yield of an Open Well .....	266
Annexure 11- Guidelines for Sustainability of Ground Water Sources.....	268
Annexure 12 -Disinfection of Water .....	272
Annexure 13 -Sanitary Protection of Wells and Springs .....	280
Annexure 14- Mitigation Measures for Fluoride Contamination .....	286
Annexure 15- Selection of Safe Sanitation Technologies.....	288
Annexure 16 -Recommended Construction Practices for Twin Pit Pour Flush Latrines.....	291
Annexure 17- Guidelines for Solid and Liquid Waste Management .....	293
Annexure 18 -Formats for Environmental Data Sheets (EDS).....	307
Annexure 19- Categorization of Schemes.....	322
Annexure 20 -Environmental code of Practices for Water Supply and sanitation for Jalanidhi-2 .....	323
Annexure 21- LEA Format for Medium Impact Schemes .....	328
Annexure 22- Model ToR for Conducting EIA for High Impact Schemes.....	333
Annexure 23- Proceedings of the Public Consultation Programme .....	339
Annexure 24- Query rose during Public Consultation and the reply addressed in subsequent pages of the Report .....	345

### LIST OF ACRONYMS

ADB	Asian Development Bank
AHADS	Attapady Hills Area Development Society
ARWSP	Accelerated Rural Water Supply Programme
ARWSS	Accelerated Rural Water Supply Scheme
ASHA	Accredited Social Health Activists
ASSO	Attapady Social Service Organization
BG	Beneficiary Group
BGL	Below Ground Level
BIS	Bureau of Indian Standards
BOD	Bio-Chemical Oxygen Demand
BP	Bank Procedure
BPL	Below Poverty Line
CADA	Command Area Development Authority
CBO	Community Based Organization
CCDU	Communication and Capacity Development Unit
CGWB	Central Ground Water Board
CKM	Clean Kerala Mission
COD	Chemical Oxygen Demand
CPCB	Central Pollution Control Board
CRSP	Central Rural Sanitation Programme
CRZ	Coastal Regulation Zone
CT	Census Town
CWRDM	Centre for Water Resources Development and Management
CWSS	Community Water Supply Schemes
D.C.	District of Columbia
DAS	Detailed Appraisal Sheet
DDP	Desert Development Programme
DO	Dissolved Oxygen
DP	District Panchayat
DPC	District Planning Committee
DPR	Detailed Project Report
DWSC	District Water and Sanitation Committee
DWSM	District Water and Sanitation Mission
DWSS	Department of Water Supply and Sanitation
EA	Environmental Assessment
EC	Electrical Conductivity
EDS	Environmental Data Sheet



---

EIA	Environmental Impact Assessment
ELF	Engineered Land Fill
EMF	Environmental Management Framework
EPA	Environmental Protection Agency
FC	Fully Covered
FC	Faecal Coliforms
FGD	Focused Group Discussion
GIS	Geographic Information system
GO	Government Order
GoI	Government of India
GoK	Government of Kerala
GP	Gram Panchayat
GPAT	Gram Panchayat Action Team
GPE	Gram Panchayat Engineer
GWMW	Ground Water Monitoring Well
GWR	Ground Water Recharge
HH	House Hold
HP	Horse Power
HRD	Human Resources Development
HTL	High Tide Line
HUDCO	Housing and Urban Development Corporation
ICB	International Competitive Bidding
ICDS	Integrated Child Development Services
ICEF	India Canada Environment Facility
ICR	Implementation Completion Report
IEC	Information Education and Communication
IHHL	Individual House Hold Latrines
IS	Indian Standard
ISL	Individual Sanitary Latrine
JBIC	Japan Bank for International Cooperation
JICA	Japan International Cooperation Agency
JNNURM	Jawaharlal Nehru National Urban Renewal Mission
JWR	Joint Water Regulation
KCIP	Kerala Community Irrigation Project
KMIP	Kerala Minor Irrigation Project
KMML	Kerala Minerals and Metals Limited
KRWSA	Kerala Rural Water Supply and Sanitation Agency
KSEB	Kerala State Electricity Board
KSPCB	Kerala State Pollution Control Board
KSUDP	Kerala Sustainable Urban Development Project

---

---

KTSHM	Kerala Total Sanitation and Health Mission
KWA	Kerala Water Authority
LCB	Local Competitive Bidding
LIC	Life Insurance Corporation of India
LPCD	Liter Per Capita per Day
LSGI	Local Self Government Institution
LWSS	Large Water Supply Scheme
MCM	Million Cubic Meters
MNP	Minimum Needs Program
MNREGA	Mahatma Gandhi National Rural Employment Guarantee Act
MOU	Memorandum of Understanding
MPN	Most Probable Number
MoEF	Ministry of Environment and Forests
MSW	Municipal Solid Waste
NABARD	National Bank for Agriculture and Rural Development
NAS	National Accounts Statistics
NC	Not Covered
NDWM	National Drinking Water Mission
NGO	Non Governmental Organization
NGP	Nirmal Gram Puraskar
NRDWP	National Rural Drinking Water Programme
NRHM	National Rural Health Mission
NRI	Non-Residents of India
O & M	Operation and Maintenance
OD	Operational Directive
OG	Out Growth
OHT	Over Head Tank
OP	Operational Policy
PAP	Project Affected Person
PC	Partially Covered
PC	Production Centre
PHC	Public Health Centre
PMU	Project Management Unit
PRI	Panchayat Raj Institution
PWD	Public Works Department
PWSS	Piped Water Supply Scheme
QC	Quality Control
R & D	Research and Development
RGNDWM	Rajiv Gandhi National Drinking Water Mission
RIDF	Rural Infrastructure Development Fund

---



---

RPMU	Regional Project Management Unit
RSM	Rural Sanitary Mart
RWH	Rain Water Harvesting
RWSS	Rural Water Supply and Sanitation
SC	Scheduled Caste
SE	Senior Engineer
SLC	Scheme Level Committee
SLWM	Solid and Liquid Waste Management
SO	Supporting Organization
SSHE	School Sanitation and Hygiene Education
ST	Scheduled Tribe
SWSM	State Water and Sanitation Mission
SWSS	Single Water Supply Scheme
TC	Total Coliforms
TDP	Tribal Development Plan
TEAP	Tsunami Externally Aided Project
ToR	Terms of Reference
TPD	Tonne Per Day
TRP	Tsunami Rehabilitation Programme
TSC	Total Sanitation Campaign
TSDF	Treatment Storage and Disposal Facility
UDD	Urine Diversion and Dehydration
UIDSSMT	Urban Infrastructure Development Scheme for Small and Medium Towns
ULB	Urban Local Body
UNDP	United Nations Development Programme
UNEP	United Nations Environment Programme
USAID	United States Agency for International Development
UT	Union Territory
WB	World Bank
WQM	Water Quality Monitoring
WSS	Water Supply and Sanitation

## EXECUTIVE SUMMARY

### INTRODUCTION

Kerala Rural Water Supply and Sanitation Agency (KRWSA), an important player in rural water supply and sanitation sector was constituted to implement "Jalanidhi" Project and has successfully developed a viable alternate model for service delivery, based on the sound principle of cost recovery. The organization has acquired unique expertise in rural water supply and sanitation projects and plays a pivotal role with the Gram Panchayats in implementing community based water supply schemes and appropriate sanitation measures to ensure safe water, health and hygiene to the rural people of Kerala. Jalanidhi 1 project completed during the year 2000-2008, with a project cost of Rs.381.50 crores, had implemented 3705 water supply schemes covering 112 Gram Panchayats. Consequent to the successful implementation Jalanidhi-I, Government of Kerala has decided to implement Jalanidhi-2, with World Bank support and contribution from local self governments and the beneficiaries. The main components of Jalanidhi-2 includes community based water supply schemes, rehabilitation of single GP KWA schemes, sanitation, Ground Water Recharge, Rain Water Harvesting and special emphasis on water supply to quality affected habitations.

The proposed Kerala Rural Water Supply and Sanitation project falls under environmental category 'B' as per World Bank's safeguard policies laid down in OP 4.01 on EA. The OP 4.01 requires the borrower to screen projects upstream in the project cycle for potential impacts. Thereafter, an appropriate Environmental Assessment (EA) to assess, minimize and mitigate potentially adverse impacts is selected depending on nature and scale of project. The EA needs to be integrated in the project development process so that timely measures can be applied to address the identified impacts.

M/s. ABC Environs Solutions Pvt. Ltd. Chennai has been entrusted the Environmental Analysis (EA) study, with a view to identify the critical environmental concerns in the RWSS sector and to put forth a mechanism to address these issues, through an Environmental Management Framework (EMF).

Based on secondary data collection, field visits and Focused Group Discussions in selected 14 Gram Panchayats in nine Districts, the Consultant prepared a report on EMF. The Grama Panchayats were selected based on the geographical position, water quality issues, water quantity criteria and proximity to natural habitats.

### KEY ENVIRONMENTAL ISSUES

The main source of water for Kerala is rainfall, which is estimated to be 3000mm on an average. Kerala has 44 rivers with a total annual discharge of 77900 Mm<sup>3</sup>. The net groundwater availability the entire Kerala State is 6229.55 million cubic meter (MCM).



However, an analysis of the baseline environmental situation, observations during site visits, discussions with State, District and GP level functionaries as well as the Focused Group Discussions have identified the following key environmental issues.

- a. Inadequate or disrupted water supply
- b. Bacteriological contamination of surface and ground water quality.
- c. Presence of Salinity, Iron and Fluoride concentrations exceeding the permissible levels in drinking water.
- d. Lack of sanitation facilities.

#### **MITIGATION MEASURES**

Mitigation measures for each of the issues noted above have been identified during the environmental assessment and consultation. These include;

**Water Availability:** Using scientific methods to identify ground water source locations, targeted GWR measures, designing scheme service levels (per capita supply) in line with water availability, roof water harvesting techniques, promoting integrated management of local water resources by the BGs and the GPs, and enacting and enforcing ground water legislation.

**Water Quality:** The major factors causing pollution of traditional sources of water supply are absence of scientific waste disposal and the poor construction of the well. Hence, scientific disposal of waste and sanitary protection of wells and springs will practically eliminate contamination from the surface through leaching of spill water, storm water and agricultural runoff. Effective and continuous disinfection of all drinking water supplies to maintain minimum residual chlorine of 0.2-0.5 mg/l, after a contact time of 30 minutes (WHO, 1984) and treatment of saline water and effective treatment of solid and liquid waste.

**Sanitation and Environmental Health:** Adopting safe sanitation technologies, promoting the conversion of existing insanitary latrines into safe ones, pilot projects on safe disposal of Municipal Solid Waste and minimizing indoor air pollution (IAP), protecting drinking water wells by lining, disinfecting drinking water and an effective and sustained program of creating awareness on linkages between improved sanitation, hygiene and health through multimedia (including the mass media) and supporting village based water quality control programs. Effective methods for the disposal of solid waste through effective and appropriate methods

#### **POLICY AND REGULATORY FRAMEWORK**

The proposed Jalanidhi-2 project will address all the issues of concern as laid down in the OP 4.01 of World Bank on EA. Though there are no specific clearances required from the Ministry of Environment, GOI, all the provisions in the various Central and State Acts, relevant in the context of the proposed project were incorporated during the implementation of the project.



The World Bank Safeguard Policies which are triggered for this project are  
**OP/BP 4.01 Environmental Assessment** - The EMF includes a details description of assessment procedures for each of the activities proposed under the Jalanidhi project. Screening and assessment tools as well as detailed guidelines have been developed for all proposed schemes.

**OP/BP 4.04 Natural Habitats** - Applicable, if the schemes to be taken up under the project are located near natural habitats. However, assessment procedures and mitigation measures have been put into place through the EMF so that any negative impacts on the natural environment are minimized.

**OP/BP 4.36 Forestry**- Some of the schemes taken up under the project will be located in forest areas. Mitigation measures have been appropriately included into the Environmental Management Framework (EMF) to ensure that in all schemes which have a component located on forest land. The required permission is taken through the Forest Department (for approval of the Government of India under the Forest Conservation Act, 1980). Also, any required felling of trees in forest or non forest areas is done with the permission of the Forest Department and in accordance with guidelines for compensatory afforestation.

**OP/BP 4.12 Involuntary Resettlement**- The project will ensure that people are not displaced as far as possible. Schemes components will be sited as far as possible on Government or Panchayat lands. Resettlement Policy Framework has been prepared separately. Involuntary acquisition will be avoided.

**OP/BP 4.20 Indigenous Peoples**- Adverse effects on the indigenous people will be avoided. Indigenous people will be benefited with access to water supply and sanitation.

#### **ENVIRONMENTAL MANAGEMENT FRAMEWORK**

In order to ensure that the environmental issues are systematically identified and addressed in the various stages of the implementation of the schemes, an Environment Management Framework (EMF) has been developed for this project. The specific objectives of the EMF are as under:

- To design a set of procedures, delineate the roles and responsibilities of various Stakeholders, and institutional structure in the implementation of sub projects along with the capacity building and staffing requirements for mainstreaming environmental management in project implementation processes
- To identify appropriate mitigation measures for addressing the identified environmental issues

In order to facilitate the effective implementation of EMF the Schemes are classified as Category I (low impact), Category II (medium impact) and Category III (high impact) according to pre-specified classification criteria. The set of procedures to be followed for this is outlined in the EMF.



The classification of the water supply schemes is an essential component and it requires the data on source of water supply, water quality problem, proposed water treatment, sanitation facilities, sullage conveyance, treatment and disposal, solid waste disposal etc. For recording all these details an Environmental Data Sheets (EDS) for schemes on water supply, sanitation, solid and liquid waste management etc., have been formulated. The EDS will be compiled at the field data collection stage of the proposed Water Supply and Sanitation Scheme.

#### **ENVIRONMENTAL APPRAISAL AND APPROVAL**

Based on the category under which a given sub-project is classified, suitable and commensurate environmental assessment and mitigation planning procedures should be applied. The procedures could vary for different categories.

- For low impact category (Category I), a set of very simple mitigation steps have to be incorporated in the project plan based on the Environmental Codes of practices and technical guidelines.
- For medium impact category (Category II), possibly a Limited Environmental Assessment (LEA) can be undertaken either through RPMU or an environmental consultant. This may pertain to collection of information on source, sanitation, quality of water etc, and its analysis for environmental implication.
- For high impact category (Category III), a full-fledged EIA has to be conducted through an environmental consultant. In this case, an appropriate ToR and consultant profile for hiring such an expert should be prescribed.

The Detailed Project Report (DPR) for Category I schemes should be accompanied by the Environmental Data Sheet (EDS). The GPE of the RPMU will ensure this. The Detailed project Report (DPR) for Category II & III schemes should be accompanied by the Environmental Data Sheet (EDS) as well as the LEA/EIA, which applicable. The Manager (Technical) of RPMU will ensure this.

#### **ENVIRONMENTAL SUPERVISION, MONITORING & EVALUATION PLAN**

The implementation of water supply and sanitation schemes is likely to result in varying level of environmental impacts that would require supervision and monitoring to:

- Ensure that mitigation measures (including construction stage) have actually been adopted by the respective identified agency as per the responsibility matrix. The effectiveness of mitigation measures can be improved through a feedback mechanism, for planning and execution of future similar projects.
- Provide a means whereby any impacts which were subject to uncertainty at the time of preparation of the EA, or which were unforeseen, can be identified, and to provide a basis for formulating appropriate additional impact control measures



- Supervision, monitoring and evaluation of water quality and environmental indicators are conducted, as a part of the overall project monitoring program.
  - External monitoring will be done by external agency twice in 5 years
  - Internal monitoring will be done by RPMU of KRWSA twice a year.
  - Other local level monitoring will be done by Health Department of GoK, National Rural Health Mission. ASHA or Anganwadi workers.
- IEC activities are undertaken for awareness raising and sensitization regarding personal and public hygiene, environmental sanitation, and water conservation, as an integrated component of the project IEC activities.

#### **INSTITUTIONAL ARRANGEMENTS FOR ENVIRONMENTAL MANAGEMENT**

The personnel and agencies with the responsibility for environmental management will be located as follows in the project institutional structure:

- KRWSA will be staffed with technical unit for Rural Water Supply and Sanitation
- The State Project Management unit will be headed by Directors who provide guidance and technical support to RPMU Engineers
- Each of the RPMU will be staffed with a Senior Engineer designated as Manager (Technical) and will appoint Engineers to each of the Gram Panchayats.
- A panel of technical experts at the State and District level will be constituted to provide technical support to PMU and RPMU.

#### **TRAINING AND CAPACITY BUILDING**

The overall capacity building component of the project will aim:

- To build and strengthen the capability of rural water and sanitation agency institutions (KRWSA, KWA) and other partners (NGOs, contractors and Supporting Organizations) to integrate sound environmental management in water and sanitation services.
- To orient the service delivery of the project staff and GP representatives to the requirements of the projects' Environmental Management Framework.
- Systematic capacity building initiatives will be introduced only after the completion of training needs assessment.
- The training will be of Cascade mode. All the trained staff will in turn conduct further trainings at State, District and Gram Panchayat levels for improved service delivery.

#### **TRAINING PROGRAMMES**

The various training programmes will be provided to fulfill the above said objectives. A short description regarding training programmes is given below and detailed in Table 4.4 of Chapter IV.



- Training on 'Introduction to Environmental Management in Jalanidhi-II' will be given to Engineers of Gram Panchayat and Supporting Organizations, Senior Engineer of RPMU and Resource Personnel.
- Training program on water quality and environmental sanitation will be given to BG, SOE and GPE.
- Thematic training programmes focused on a particular theme will be given to limited number of Engineers.

**BUDGET FOR EMF IMPLEMENTATION**

The total expected budget for Environmental activities under the proposed Jalanidhi-2 scheme is found to be 1.35 crores and is detailed in Table.

**Budget for Environmental Management**

S.No	Activity	Amount (in Crores)
1	Training	37,24,000
2	Internal supervision visits* @ 2 lakhs / year for 5 years	10,00,000
3	Environmental Audit by the external agency during the end of second and fourth year of the project period @ Rs. 10 lakhs / audit	20,00,000
4	Preparation of specific environment related community awareness materials at state level	5,00,000
5	EA for schemes @ 10 lakhs per year for 5 years	50,00,000
	Sub Total	1,22,24,000
	Contingencies @ 10 %	1222400
	<b>Total</b>	<b>1,34,46,400</b>

\*Internal visits will be done for low and medium impact projects by SE of RPMU and by SLC or D (T) of PMU for high impact project during EMF implementation.

**PUBLIC CONSULTATION**

The Public Consultation Programme on Environmental Impact Assessment, Environmental Management Framework and Tribal Development Plan for the proposed Jalanidhi phase 2 was held on 14.06.2011, 10.30 AM at Institution of Engineers Hall, Trivandrum.

KRWSA has taken following steps for public disclosure of the report:

- The report will be displayed on the website to seek the public opinion / comments.
- Report will be circulated to District Collector
- Report will be circulated through listed NGOs.



At the meeting, there was overwhelming response from the public, beneficiaries and NGOs. The project benefits, Environmental issues, Environment management, Tribal Development Plan etc were the main aspects of the consultation. This was intended at updating the understanding of the villagers regarding the Rural water supply and sanitation project and soliciting there feedback on the proposed EMF.

## 1. INTRODUCTION

### 1.1 BACKGROUND

Government of Kerala (GoK) in 1999 has set up an autonomous registered society, the Kerala Rural Water Supply and Sanitation Agency (KRWSA) to implement the World Bank aided Rural Water Supply & Sanitation project - Jalanidhi, adopting the principles of demand responsiveness, community ownership and sustainability of investments through cost recovery in 112 Gram Panchayats of Kerala in a phased manner from 2001. So far, KRWSA has taken up 3696 small water supply schemes and 16 large surface based water supply schemes including Tsunami Rehabilitation Scheme under the project. Of these, 3693 small water supply schemes and 12 large water supply schemes have already been commissioned benefiting 10.09 lakh populations. Thus, Jalanidhi successfully demonstrated that communities could demand, plan, design, own and manage water supply & sanitation facilities and share investment cost with 100 % recovery of operation and maintenance cost. Also in this context, the GoK has sought World Bank Financing for the proposed Second Phase of Jalanidhi. The objective of the proposed project is to assist GoK in expanding access to sustainable RWS schemes and to consolidate its demand responsive and decentralized service delivery model, for rural water supply & sanitation. The proposed project is intended to cover 200 Gram Panchayats in all the 14 Districts of Kerala.

Operational Policy 4.01 (OP 4.01) is one of the ten safeguard policies of the World Bank, which provides the Environmental Assessment (EA) guidance for the lending operations. The proposed Kerala Rural Water Supply and Sanitation project falls under environmental category 'B' as per Bank's safeguard policies laid down in OD 4.01 of World Bank on EA. The OD 4.01 requires the borrower to screen projects upstream in the project cycle for potential impacts. Thereafter, an appropriate Environmental Assessment (EA) approach to assess, minimize / enhance and mitigate potentially adverse impacts is selected depending on the nature and scale of project. The EA needs to be integrated in the project development process such that timely measures can be applied to address the identified impacts. The policy requires consultation with affected groups and NGOs to recognize community concerns and the need to address the same as part of EA.

As an integral part of the Jalanidhi - 2 program design and implementation strategy, M/s. **ABC Environ Solutions Pvt. Ltd.**, has been entrusted with the Environmental Impact Assessment study and preparation of an Environmental Management Framework (EMF), with a view to identify the critical environmental concerns in the RWSS sector and provide a mechanism to address these, through an Environmental Management Framework (EMF).

### 1.2 KERALA RURAL WATER SUPPLY AND SANITATION AGENCY (KRWSA)

KRWSA, which is, today an important player in the rural water supply and sanitation sector, has successfully developed a viable alternate model for service delivery, based on the sound principle of cost recovery. Over the last ten years since its inception, this agency, which was constituted as a special purpose vehicle to implement Jalanidhi - Rs.381 Crore World Bank aided Rural Water Supply and Sanitation Project, has acquired unique expertise in rural water supply and sanitation projects. The Jalanidhi project plays a central role to the Gram Panchayat in implementing community

based water supply projects. KRWSA, has also networked itself with a large pool of NGOs in accomplishing the challenging job of mobilizing communities and enabling them to have water supply and sanitation facilities owned and managed by themselves.

The overall project development objective is to assist the Government of Kerala (GoK) in improving the quality of rural water supply and environmental sanitation service delivery, to achieve sustainability of investments. Specific project development objectives are: (a) to demonstrate the viability of cost recovery and institutional reforms by developing, testing and implementing a new decentralized service delivery model on a pilot basis; and (b) build the State's capacity in improved sector management in order to scale up the new decentralized service delivery model Statewide. This will assist GoK in furthering its sector related goal of increasing the access of Kerala's rural population, particularly the poor and socially disadvantaged groups, to drinking water supply and environmental sanitation services.

### 1.3 JALANIDHI - 1

Jalanidhi-1 Project was originally designed to implement in 80-100 Gram Panchayats in four districts viz, Thrissur, Palakkad, Malappuram and Kozhikode. As per the revised plan, by the end of 2006, 92 Gram Panchayats spread over Thrissur, Palakkad, Malappuram and Kozhikode Districts and 18 Gram Panchayats spread over remaining 9 Districts, excluding Alappuzha, were included in the project with an estimated (revised) cost of Rs.381.5 Crores.

The GoK has been positive towards the results shown by this pilot project, which is evidenced by the reforms model being accepted in the planning process, for the water and sanitation sector, not only in the 10th Five Year planning exercise but also in the "modernization of GoK programmes". The project was successful even in tribal hamlets of Attapady, where contribution to the scheme was collected as labour through trenching activities. Inspired by the success of this model, the GoK has decided to go in for a follow on project and accordingly submitted a proposal, amounting to Rs.1200 Crores to GoI for approval.

The project has eliminated corruption through community participation and transparency in each step of the project. The community had the opportunity to involve in procurement, material selection, material testing and quality monitoring, thereby increasing transparency and accountability of the project. Initial and final estimates are discussed within the community, including the approved rates and specifications. Community involvement has also accelerated the hygiene and sanitation drive in rural areas. Bulk purchases and supporting organization's negotiation skills have helped cost effective latrine constructions at many places including tribal hamlets. Locally available materials and skill have been effectively utilized to reduce the cost of superstructure. Tribes have made use of bamboo and mud, which are readily available in these areas.

#### 1.3.1 LESSONS LEARNT AND REFLECTED IN THE JALANIDHI - 2 PROJECT DESIGN

KRWSA has successfully implemented Jalanidhi project in about 3000 habitations. Sustainability studies have indicated that, the schemes are providing water at designed service level and technically sustainable mode. Few lessons, which are to be incorporated in Jalanidhi - 2, are

- (a) Water supply schemes implemented are simple water supply and comprehensive water supply schemes, which included newly constructed/renovated schemes which have low impact on environment.
- (b) Organizational setup of the Project was systematic and well organized which help in proper implementation of EMF activity.
- (c) The source was poor in certain location that resulted in inadequate supply of water. Source should be identified following the guidelines for water supply sources.
- (d) For empowering the beneficiaries, training programmes are organized.
- (e) Selection of low quality materials affected the water quality resulting in damage to pipelines. Standard make of materials can prevent such issues.
- (f) Monitoring of water quality was not performed regularly. This has to be given importance and should be performed regularly.
- (g) With the emergence of Jalanidhi schemes in Kerala, women came forward to take responsibility, right from the planning phase to post implementation phase. They were able to get more income, through skill development trainings and corresponding jobs.
- (h) Since, many of the water supply schemes in Jalanidhi are depending on ground water; sustainability of source is a problem. To combat this, GWR component has to be strengthened for conservation of water and to avoid drying up of sources. Hence, this component may be made compulsory in line with water supply.

#### 1.4 PROPOSED WORLD BANK AIDED JALANIDHI 2 - OBJECTIVES

The key objectives of the proposed project are:

- To improve the quality of rural water supply and sanitation services and to achieve sustainable development,
- Poverty reduction,
- Sustainable health and hygiene benefits to the rural population,
- Empowerment and inclusion of community in general and rural poor and women in particular,
- Strengthening the decentralization process

#### 1.5 TECHNICAL ASPECTS OF JALANIDHI - 2

There are no major technical issues to be addressed during preparation of water supply schemes or their implementation, since in the implementation of Jalanidhi - 1 the KRWSA has successfully demonstrated an alternative service delivery model focused on reaching those without coverage within each GP.

##### 1.5.1 COMPONENTS

###### a. *Water supply Schemes*

Majority of the water supply schemes proposed will be piped water schemes with a few rainwater-harvesting schemes. The project will finance some 4500 small drinking water supply schemes covering about 35 households

each. Over 90% are expected to opt for local ground water sources like open wells, deep bore wells and springs. Most schemes will involve pumping, construction of storage tanks and piped distribution networks.

Where ground water is scarce, a few large water supply schemes are likely to be chosen with surface water sources like river, where the water will have to be conveyed from long distances. These schemes will involve construction of infiltration wells/galleries or conventional water treatment plants and may cover entire GP.

**Multi- GP water supply schemes:** KWA has gained much experience in undertaking conventional engineering design and construction of multi GP water supply schemes. 3 multi GP KWA rehabilitation schemes is proposed in line with the new GOI guidelines such that GPs implement and manage the internal water distribution system, whereas KWA implements and manages the bulk water supply system from source to the GP entry points, and collects bulk water tariffs from the GPs as determined by GOK.

**Rehabilitation of Single GP KWA scheme:** The sub-component would support the rehabilitation of existing KWA water supply system where required by augmenting the source, protection of the sources from pollution, construction of new facilities and repairs and replacement of the existing structures, machinery, equipment and pipelines to conform to the technical standards. Cost sharing will be same as that of the new water supply schemes.

Apart from this around 250 single GP scheme will be rehabilitated outside the project GPs as part of KRWSA-KWA partnership programme by KWA.

#### ***Safe Drinking Water to Habitations***

All schemes will use disinfections mechanism based on size and source of the schemes; however small schemes will use bleaching powder. The cost sharing will be 75% by GOK, 15% by GP and 10 % by the beneficiaries and reduced cost sharing of 7% for the SC/ST/Fishermen and the destitutes.

#### ***b. Ground Water Recharge and Rain Water Harvesting Schemes at Household Level***

In Kerala generally every household has an open well, which provides adequate water security at household level. Water security at household level will be ensured by strengthening with recharge facilities of the household sources, which will be used when the piped water supply scheme fails. Based on experience, appropriate programmes are proposed in Jalanidhi - 2 to ensure source sustainability.

#### ***c. Sanitation***

Improvements in household sanitation have been impressive in the State. The project will include sanitation component to achieve hard-to-reach household sanitation gap; replicating successful community sanitation interventions; reversing the contamination of groundwater by deep pit latrines; and implementing/improving local drainage and solid waste management solutions. Strategy components and process components pertaining to sanitation in Jalanidhi - 2 are detailed in **Annexure 1**.



The following sanitation components are proposed for Jalanidhi - 2

*Safe disposal of human excreta*

- Subsidy for construction of HH toilets for tribal people in 24 tribal projects
- Piloting new technologies for latrine solutions in water logged /difficult areas
- Pay and use latrine in appropriate locations (markets, tourist spots etc)

*Safe disposal of solid waste*

- Community based vermin composting units /biogas units in hotspots
- Processing of the market waste through composting or bio-methanation technologies by the GPs
- Implement processing units for plastic (shredding units)
- Implement recyclic units for plastics.

*Safe disposal of liquid waste*

- Implement drainage interventions in critical sections of GPs with disposal systems to protect the water sources
- Piloting of septage treatment facility in one district

*Capacity building for water safety*

- Set up water quality testing facilities in the GPs to be based in higher secondary schools for ongoing testing of drinking water sources including domestic wells.

*d. Operation and Maintenance arrangements*

The BGs are efficiently managing the O&M of small WS schemes in Jalanidhi - 1 except disinfection. They are also unable to maintain the pressure filters etc and hence there is a need for annual maintenance contracts for such equipment. The large water supply schemes in Jalanidhi - 1 are being operated by the Scheme Level Committee (SLC). In Jalanidhi - 2 wherever required, outsourcing will be done for the O&M of large WS schemes through service management contracts.

**1.5.2 WATER DEVELOPMENT PLANS**

Water Development plans will be prepared for all GPs, which will enable identify habitations requiring water supply and selection of sources, and ensuring water security/safety. Water safety will be ensured through protection of sources and security will be achieved by appropriate ground water recharge measures using GIS software.

**1.5.3 TECHNICAL MANUAL**

In Jalanidhi - 1 small water supply schemes have been designed by engineers employed by Support Organizations and large schemes were designed by private sector engineering consultants using a technical manual developed for the project. These engineers possess the required capabilities for design, construction and O&M of the small water supply schemes. However, with a view to enhance the quality of designs and drawings and save time in

planning, the technical manual prepared for use in Jalanidhi - 1 project will be updated for use in Jalanidhi - 2 to conform to latest IS codes, including new technologies and to reflect the lessons of experience of the first project.

Some of the new topics to be included in the manual are:

- Type designs of overhead tanks to conform to latest BIS codes (with concrete proportion M30)
- Preparation of GIS base maps for GPs, Total station survey road maps of the GPs for water development plan
- The use of filtration/reverse osmosis processes, for de-fluoridation and iron removal for providing safe drinking water in water quality affected GPs
- Disinfection with on-site generation of hypo and silver ionization plants
- Use of standard software for design of distribution system (EPA net)
- Procedures for preparation of GP wise water Development plans to ensure safety and security of drinking water
- Processes for rehabilitation of single GP KWA schemes
- Specifications for construction materials, goods, equipment and civil works
- Use of the technical manual along with the scientific selection of water sources is likely to result in good quality construction and sustainable water supply schemes.

#### **1.5.4 DETAILED PROJECT REPORTS**

- Detailed project reports (DPR) of individual schemes will be prepared with Water development plan for the GP with GIS base maps using total station surveys
- Designs using the software for economical size of pumping main and distribution system with software
- Revised designs of overhead tanks to conform to latest IS Codes
- Auto cad drawings
- Water quality and geophysical survey reports for source selection

#### **1.5.5 RESPONSIBILITY MATRIX FOR ENGINEERING ACTIVITIES**

A responsibility matrix has been prepared for engineering activities for preparation, approval, technical sanction of DPRs, quality monitoring and authorizing payments, completion reporting, O&M, and post implementation support, etc. KRWSA will decide the monitoring limits of sanction/ approval powers of various levels of engineers.

#### **1.5.6 QUALITY ASSURANCE**

SO Engineers and RPMU Engineers will ensure day-to-day monitoring of the works and of the materials procured for the project. Additionally, KRWSA will retain independent construction quality surveillance consultants to monitor the quality of supervision, ensure the quality of the materials procured and construction quality of the works. To promote the long term sustainability of the rural water supply and sanitation sector by identifying and implementing an appropriate policy framework and strategic plan.





## 1.6 RATIONALE FOR ENVIRONMENT ASSESSMENT / ENVIRONMENT MANAGEMENT FRAMEWORK

The proposed Jalanidhi - 2 scheme will be taken up as per the World Bank's OP 4.01. Accordingly, an Environmental Assessment (EA) of Jalanidhi - 2 has been conducted. This EA provides insight into the environmental challenges facing the project including source sustainability, water quality management, drainage and disposal and household sanitation issues. Presently, the project is under formulation. This EMF provides detailed guidance for conducting screening and environmental assessment for Jalanidhi - 2 scheme, which would be taken up by KRWSA.

The purpose of the Environmental Assessment (EA) is to identify upfront in the Jalanidhi - 2 scheme, potential environmental risks and impacts in its area of influence; examine project alternatives; identify ways of improving project selection, siting, planning, design and implementation by preventing, minimizing, mitigating, or compensating for adverse environmental impacts and enhancing positive impacts throughout project implementation. EA has taken into account the environment (air, water and land); human health and safety including the country's overall policy framework, national legislation, and institutional capabilities related to the environment and obligations of the country, pertaining to project activities, under relevant international environmental treaties and agreements.

### 1.6.1 ENVIRONMENTAL ISSUES

- a) From a study and analysis of available information it is noted that a majority of rural water supply schemes implemented in the State depend on ground water (dug wells/bore wells) as the source and that the perennality and reliability of source yield seems to be a major issue of environmental concern affecting the *availability of water*.

With regard to groundwater, water quality characteristics of wells in Kerala are found to be affected by chemical and biological contaminants. The ground water quality problems in the coastal areas are mainly due to the presence of excessive salinity. A chloride concentration >250mg/L was detected in the well water samples of Azhicode, Kakkathuruthy, Edathinjil, Kadalundi, Chellanum, Nallalam, Mankombu and Haripad. In Alappuzha district, fluoride concentration in the pumping wells was observed to be high. In midland region, the concentration of fluoride, iron and chloride were found to be on the higher side. The fluoride content was observed to be beyond the permissible limit of 1 mg/L. Deep wells in Chittur taluk and Knajikod areas of Palakkad district are found to contain fluoride concentration greater than 1mg/l.

- b) Open wells of Kerala have the bacteriological contamination. In Kerala about 60% of the population relies on ground water for drinking. At the same time studies have shown that faecal contamination is present in 90% of drinking water wells. The open nature of the wells, conventional maintenance habits, use of buckets and rope to draw water, kitchen wastes and pit latrines with average family load factor (5 members) at a distance of less than 5 meters from wells are some of the factors, which are found to be contributing to the bacteriological contamination. Ground water contamination due to industrial pollution has been reported from places of

Kochi (eastern part of Aluva), Palakkad and some parts of Kollam, Kozhikode and Kannur.

- c) The major water quality problem associated with the rivers of Kerala is bacteriological pollution. The water quality assessment studies of rivers such as Chalakudy, Periyar, Muvattupuzha, Meenachil, Pamba and Achenkovil indicate that the major quality problem is due to bacteriological pollution and accordingly the rivers fall under B or C category of CPCB classification. There are local level quality problems faced by all rivers especially due to bathing, dumping of solid waste and discharge of effluents.

## 1.7 APPROACH AND METHODOLOGY FOR EA/EMF

The methodology comprised collection of secondary data on availability of water resources, their utilization, ambient and ground water quality issues of water quantity and quality as relevant in the context of the proposed Jalanidhi - 2. The major secondary sources of data included KWA, KSPCB, CWRDM, State/ Central Ground Water Department and NGOs. The flow chart for the methodology is depicted in Figure 1.7.2-1 is briefly discussed hereunder.

### 1.7.1 SITE VISITS

Existing rural water supply systems based on ground water / surface water source were inspected to obtain first hand information on existing systems, their performance including adequacy of source, water quality, potential source(s) of contamination, constraints/problems in O & M and identification of issues, if any, that need to be addressed in the proposed project design. During the site visits, detailed discussions were held with consumers, KWA, local GPs and NGOs.

### 1.7.2 FOCUSED GROUP DISCUSSIONS

This constituted an important activity during the field visits and were held in selected GPs in each district of Kerala to assess quantity of current water supply, quality of water supply, household sanitation facility, sullage disposal, prevailing diseases, personal and environmental hygiene, their awareness of roles and expectations from the proposed Jalanidhi - 2, their views / suggestions to enhance project performance and benefits and also any other new issues needed to be addressed in Jalanidhi - 2.

#### a. Selection of GPs for FGD

The selection of Gram Panchayats for village level survey was made in consultation with KRWSA based on the guidelines and templates proposed by the World Bank and elaborated as under.

Each selected village represented in the best possible manner the typical conditions prevailing in the State. The Gram Panchayats were selected based on the water quality issues, categorization of blocks based on the level of exploitation as assessed by Ground Water department, Government of Kerala & Central Ground water Board. Apart from the water quality and water quantity criteria, the proximity to natural habitats and the physiography were also considered in the selection of GP. The selected GPs based on various criteria are given in **Table 1.1**.



**Table 1-1 Selected Gram Panchayats**

S.No	District	Block	Gram Panchayat	Reason for selection
1	Thiruvananthapuram	Athiyanoor	Kottukal	Over exploited Zone, 92 % water shortage
2		Nemom	Kaliyoor	Low land, Pollution of Vellayani Lake
3	Kollam	Mukhathala	Thrikkovilvattom	Iron problem, over exploited due to extraction from tube well, fluoride problem.
4	Alapuzha	Veliyanad	Ramanakary	Low land
5		Pattanakad	Ezhupunna/Thuravoor	Pollution due to fish processing industry
6	Ernakulam	Pampakuda	Pampakuda	Critical Block, mid land area, dug wells dry up in summer
7	Palakkad	Chittur	Eruthenpathy	Highland, Fluoride problem, over exploited zone, Proximity to forest
8		Attapadi	Agali	High land, Tribal population, forest dwellers fluoride problem, Jalanidhi -1 Scheme.
9	Thrissur	Mathilagam	Eriyad	Coastal, Degrading ground water quality due to sea erosion, over exploited zone
10	Kozhikode	Kozhikode	Ramanattukara	Over exploited zone, Pollution due to solid waste disposal.
11	Malappuram	Thirurangadi	Thirurangadi	Low land, Iron problem, semi critical zone, natural habitat (Bird Sanctuary near by) etc;
12	Wayanad	Sulthan Bathery	Sulthan Bathery	Midland, Chloride problem, Semi critical zone
13	Kasargod	Manjeswaram	Enmakaje	Midland, semi critical zone
14		Kanhangad	Kodom-Belur	Highland, surangam for water harvesting, Jalanidhi -1 Scheme, semi critical zone.

**b. Procedure for FGD**

- All the stakeholders in the identified Gram Panchayat - the target population, elected representatives of the GP, local NGOs and youth clubs were informed in advance regarding the name of village, date, time and venue of the meeting.
- The KRWSA representative/ EA consultant presented an overview of the water and Sanitation Project, the objectives and scope of the project, the various components envisaged and the rules for participation of villages in the project. This was followed by formal discussions/consultations.
- The participants, especially women, local NGOs and members of youth clubs were invited to share their views, concerns and their priorities



for the implemented project, problems/deficiencies experienced with the existing water and sanitation systems and their suggestions to make the project sustainable in achieving the objectives.

- Specifically, the demand for the project and the willingness of the target group to participate in the project, including financial contribution in construction and subsequent O&M of the project were sought.
- The views of the target group on the proposed institutional framework for implementation of the project and its continued operation, maintenance and monitoring were noted.
- The major environmental concerns of the target group in the context of the implemented project and their suggestions for mitigation of the impacts were noted.

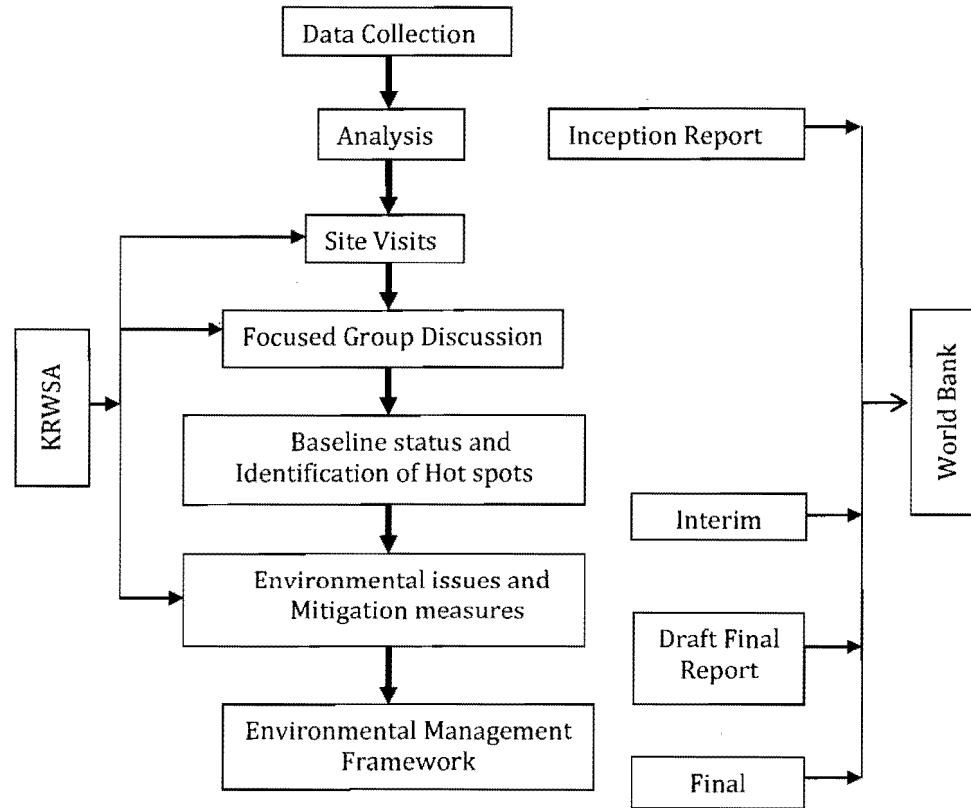

**Figure 1-1 Flow chart for Methodology**

**1.7.3 DESK STUDY**

The desk study included the following

- A review of the existing State policies and legislations as relevant to Jalanidhi -2 project
- A detailed review and analysis of available secondary data on water resources (surface and ground)
- Identification of issues Environmental concerns as related to the project
- Formulation of Environmental Management Frame work

- a. Compilation of policies and legislation, National as well as State level, that could be impacted by the activities undertaken as part of the Jalanidhi - 2 Project.
- b. Delineation of baseline status of environment in the State with a view to list and flag issues pertaining to RWSS sector which pose a threat to the environment with focus on
  - Generic environmental issues
  - Water quality issues pertaining to bacteriological, chemical and heavy metal contamination in both ground and surface water sources;
  - Environmental hygiene issues(liquid and solid waste disposal)
  - Impacts, if any on, open water bodies and human health, etc
- c. Formulation of Environmental Management Framework (EMF). This consists of
  - An organizational / institutional structure for EMF implementation. This clearly indicates responsibilities pertaining to EMF implementation that various project functionaries and officials at different levels are expected to fulfill along with the line of authority
  - A capacity building plan that ensures all parties involved in EMF implementation are adequately skilled and equipped with requisite knowledge / information to perform their respective roles
  - A monitoring mechanism that effectively provides real time information on the status and quality of EMF implementation and provides other relevant management information to concerned authorities

## 1.8 REPORT STRUCTURE

The report has been prepared in keeping with the World Bank guidelines described in O.D 4.01 and is presented in four chapters.

**Chapter I** - Introductory chapter presents the objectives of Jalanidhi - 2, the importance of Environmental Assessment, an overall description of approach and methodology followed and the lessons learnt from Jalanidhi - 1 as applicable in the implementation of Jalanidhi - 2 project.

**Chapter II** - Information on the regulatory requirements at National & State level related to environment as related to Jalanidhi - 2. This chapter also includes Rural Water Supply and Sanitation coverage in Kerala.

**Chapter III** - Baseline data on relevant environmental components in the state is presented. Based on a critical review and analysis of baseline data, the issues of environmental concerns are identified. This chapter also outlines the major issues arising from Focused Group Discussions. The potential environmental issues and their mitigation measures are also addressed.

**Chapter IV** - This chapter describes the Objectives of Environmental Management Framework (EMF), Regulatory Requirements applicable to Jalanidhi-2, Criteria for classification of schemes, list of technical guidelines, Environmental appraisal and approval, Environmental Compliance Monitoring during implementation and O & M phases and Training and Capacity Building. This report has several annexure including detailed guidelines and codes of practice for environmental management as applicable to Jalanidhi -2.

## **2. RURAL WATER SUPPLY AND SANITATION IN KERALA - POLICY, REGULATORY FRAMEWORK AND PROGRAMME**

### **2.1 NATIONAL CONTEXT OF RWSS SECTOR**

Drinking water supply and sanitation are State subjects, included in the Eleventh Schedule of the Constitution among the subjects that may be entrusted to Panchayats by the States. The Government of India supplement efforts made by the States by providing financial and technical assistance under the two centrally sponsored programmes, namely, the Accelerated Rural Water Supply Programme (ARWSP) and the Central Rural Sanitation Programme (CRSP). Substantial investment to the tune of about Rs.50, 000 Crore has been made in the rural water supply sector alone by the Central and State Governments since 1<sup>st</sup> Five Year Plan in approx. 37 lakh hand pumps and 1.45 lakh piped water supply schemes, crediting the country with one of the largest rural drinking water supply networks in the world. While significant achievement has been made in terms of providing access to potable drinking water - with 95.34% rural habitations fully covered and another 4.28% partially covered - the sanitation coverage in rural areas continues to be a challenge, with only 22% of the rural population having access to basic sanitation, as per the 2001 Census.

### **2.2 GOVERNMENT OF INDIA PROGRAMMES - NATIONAL & STATE**

A national water supply and sanitation programme was introduced in the social sector in the country in 1954. The Government of India assisted the States to establish special investigation divisions in the Fourth Five Year Plan to carry out identification of problem villages. Taking into account the magnitude of the problem, and to accelerate the pace of coverage of problem villages, the Government of India introduced the Accelerated Rural Water Supply Programme (ARWSP) in 1972- 73 to assist States and Union Territories with 100% grants-in-aid to implement drinking water supply schemes in such villages. The entire programme was given a Mission approach when the Technology Mission on Drinking Water Management, called the National Drinking Water Mission (NDWM), was introduced as one of the five Missions in social sector in 1986. NDWM was renamed as Rajiv Gandhi National Drinking Water Mission (RGNDWM) in 1991. During the International Water and Sanitation Decade in 1980s, Central Rural Sanitation Programme (CRSP) was launched in 1986 in the Ministry of Rural Development to accelerate sanitation coverage in rural areas with the objective of improving quality of life of the rural people and to provide privacy and dignity to women. Presently, Rajiv Gandhi National Drinking Water Mission (RGNDWM), Department of Drinking Water Supply, Ministry of Rural Development administers the Centrally Sponsored programmes in Rural Drinking Water Supply and Rural Sanitation sectors.

During the Ninth-Plan period, special initiative was taken to cover rural habitations with proper sanitation. The CRSP was restructured in 1999 with a provision for phasing out the allocation-based component by the end of the IX Plan i.e. 2001-2002. The Total Sanitation Campaign (TSC) under the restructured CRSP was launched with effect from 1.4.1999 adopting a community led and people centered approach. TSC moves away from the principle of state-wise allocation to a "demand driven" approach. The programme gives emphasis on Information, Education and Communication (IEC) for demand generation of sanitation facilities and offering a wide range of technological



choices of sanitation hardware through an effective delivery mechanism of Rural Sanitary Mart and Production Centers to meet the demand for sanitation facilities so generated. It also lays emphasis on school sanitation and hygiene education for bringing about attitudinal and behavioral changes for relevant sanitation and hygiene practices from young age.

The X Plan accords the highest priority to providing the "Not Covered" (NC) habitations with sustainable and stipulated supply of drinking water. It is envisaged to cover all the rural habitations including those, which might have been slipped back to NC/PC category by the end of X Plan. The Tenth Plan emphasizes the participatory approach where PRIs should be the key institutions for convergence of drinking water supply programmes at the ground level. Considerable success has been achieved in meeting drinking water needs of the rural population. As per the latest report received from the States/UTs, the coverage status as on 1.11.2004 based on comprehensive Action Plan, 1999 and coverage reported by States/UTs thereafter is given in **Table 2. 1**.

**Table 2-1 Coverage Status of Water Supply Schemes**

Type of Coverage	No. of Habitations	% of total
Not Covered (NC)	5368	0.38
Partially Covered (PC)	60884	4.28
Fully Covered (FC)	1356031	95.34
Uninhabited/ migrated	381	-
<b>Total</b>	<b>1422664</b>	<b>100</b>

The Eleventh Five Year Plan (2007-2012) targets to 'provide clean drinking water for all by 2009 and ensure that there are no slip-backs by the end of the Eleventh Plan. The Plan also targets to install 7.29 crore individual toilets for achieving universal sanitation coverage in rural areas.

#### **2.2.1 ACCELERATED RURAL WATER SUPPLY PROGRAMME (ARWSP)**

Though Rural Water Supply is a State subject, recognizing the importance of providing safe drinking water in rural habitations, Government of India has been providing financial assistance to State Governments under the Centrally Sponsored Scheme "Accelerated Rural Water Supply Programme (ARWSP)". With 100% grant in aid to the States, greater emphasis was placed on coverage by difficult habitations in the state. The programme was withdrawn after 1973-74, following the introduction of minimum needs programme (MNP) under the fifth five year plan. The slow progress achieved by the states in the supply of safe drinking water to the rural population under MNP led to the reintroduction of ARWSP in 1977-78.

The approach to water supply and sanitation in the Eighth, Ninth, Tenth and Eleventh Plans broadly followed the guiding principles of the New Delhi declaration, adopted by the United Nations General Assembly in December 1990. These include (a) protection of the environment and safeguarding of health through integrated management of water resources and liquid and solid waste; (b) organization of reforms, promoting an integrated approach including changes in procedures, attitudes, and behavior, and the full participation of women at all levels; (c) community management of services, backed by measures to strengthen local institutions in implementing and sustaining water and sanitation programmes; and (d) sound financial practices,

achieved by better management of existing assets and extensive use of appropriate technologies.

**a) Delegation of Power**

Keeping in view the concept of decentralization of power, Government of India has delegated powers to States. All projects and schemes proposed under ARWSP are approved by the State Level Scheme Sanctioning Committee. Under Sector Reforms Pilot Projects, powers to plan and implement projects and schemes have been delegated to the community, who will also own, operate and maintain the systems. The community also has the power to choose the systems of their preferences.

**b) Role of Panchayats**

As per the 73<sup>rd</sup> Amendment to the Constitution of India, the subject of rural water supply vests with the Panchayat Raj Institutions (PRIs). The Panchayats are to play a major role in providing safe drinking water and managing the systems and sources in their respective areas. They can be involved in the implementation of schemes, particularly in selecting the location of hand pumps, stand posts and spot sources, in Operation and Maintenance (O&M), etc. Moreover, Government of India emphasizes on empowering and capacity building of the PRIs to enable them for discharging their responsibilities in drinking water supply.

**Objectives**

- To ensure coverage of all rural habitations with access to safe drinking water;
- To ensure sustainability of drinking water systems and sources;
- To tackle the problem of water quality in affected habitations;
- To institutionalize the reform initiative in rural drinking water supply sector.

**Coverage Norms**

- 40 LPCD of drinking water for human beings;
- 30 LPCD of additional water for cattle in areas under the DDP;
- One hand pump or stand post for every 250 persons; and,
- Availability of water source in the habitation or within 1.6 km in the plains and 100 metres elevation in hilly areas.

**2.2.2 TOTAL SANITATION CAMPAIGN**

Total Sanitation Campaign is a comprehensive programme to ensure sanitation facilities in rural areas with broader goal to eradicate the practice of open defecation. TSC as a part of reform principles was initiated in 1999 when Central Rural Sanitation Programme was restructured making it demand driven and people centered. It follows a principle of "low to no subsidy" where a nominal subsidy in the form of incentive is given to rural poor households for construction of toilets. TSC placed strong emphasis on Information, Education and Communication (IEC), Capacity Building and Hygiene Education for effective behavior change with involvement of PRIs, CBOs, and NGOs etc. The key intervention areas are Individual Household Latrines (IHHL), School Sanitation and Hygiene Education (SSHE), Community Sanitary Complex, Anganwadis toilets





supported by Rural Sanitary Marts (RSMs) and Production Centers (PCs). The main goal of the GOI is to eradicate the practice of open defecation by 2010. To give fillip to this endeavor, GOI has launched **Nirmal Gram Puraskar** to recognize the efforts in terms of cash awards for fully covered PRIs and those individuals and institutions who have contributed significantly in ensuring full sanitation coverage in their area of operation.

The main objectives of the TSC are as under

- a. Bring about an improvement in the general quality of life in the rural areas
- b. Accelerate sanitation coverage in rural areas
- c. Generate felt demand for sanitation facilities through awareness creation and health education
- d. Cover schools/ Anganwadis in rural areas with sanitation facilities and promote hygiene education and sanitary habits among students
- e. Encourage cost effective and appropriate technologies in sanitation
- f. Eliminate open defecation to minimize risk of contamination of drinking water sources and food
- g. Convert dry latrines to pour flush latrines, and eliminate manual scavenging practice, wherever in existence in rural areas

**A sanitary latrine should not**

- a. Pollute or contaminate soil
- b. Pollute or contaminate ground water
- c. Pollute or contaminate surface water
- d. Act as a medium to fly breeding or access to flies and animals
- e. Require handling excreta
- f. Produce odor and give ugly sight
- g. Require huge investment and high technology

**Strategy**

The strategy is to make the Programme “community led” and ‘People centered’. A “demand driven approach” is to be adopted with increased emphasis on awareness creation and demand generation for sanitary facilities in houses, schools and for cleaner environment.

**2.2.3 SECTOR REFORM**

It has been realized that to strengthen the socioeconomic conditions of rural India, mere administrative decentralization or increased investment is not enough. The power of people’s participation has been recognized and brought to the fore. Despite good investments, and improvement in the rural water supply and increased outlay by the Government, particularly in the last one decade, general satisfaction is rather limited at the community level. Earlier emphasis laid on hand-pumps fitted to tube-wells and bore-wells had resulted in an impressive increase in the total rural water supply coverage. However, the availability of potable drinking water in rural areas, especially during the summer months, is still not satisfactory. Though about 1 lakh habitations are covered every year, the number of problem habitations has not declined



proportionately. Hence, Government of India realized that sustainability of sources and system is the key to people's satisfaction.

To ensure people's participation, the Central Government is following three basic principles:

- Adoption of a demand-responsive and adaptable approach based on empowerment of villagers to ensure their full participation in the project through a decision-making role in the choice of scheme design, control of finances and management arrangements;
- Shifting role of Government from direct service delivery to that of planning, policy formulation, monitoring and evaluation and partial financial support;
- Partial capital cost sharing either in cash or kind or both and 100 per cent responsibility of O&M by the users.

Accordingly, on a pilot basis, Sector Reform projects were sanctioned in 67 pilot districts across the country for implementation. Based on the demand-generated, the total estimated project outlay of Sector Reform Pilot Projects was only Rs.1328.38 crore. These pilot projects will enable the community to plan, sanction, partially fund, and implement, operate, maintain and replace Rural Water Supply Schemes of their choice. In order to instill a sense of ownership in the project, the community has to contribute at least 10% of the capital cost in either cash or kind (labour, land or material). The community will also shoulder the entire O&M cost.

In this new approach, the government plays the role of a facilitator. Efforts are being made to create awareness through Information Education and Communication (IEC) amongst the people about the need for their effective participation in this programme. The community should be willing to be involved in the implementation of the water supply schemes, for which they should have a feeling of ownership of the assets created.

#### **2.2.4 SWAJALDHARA**

The Government of India has been emphasizing the need for taking up community based rural water supply programmes and with this end in view a beginning was made in 1999 by sanctioning Sector Reform pilot Projects on experimental basis. With the experience gained, the reform initiatives in the rural drinking water supply sector have now been opened up throughout the country by launching the Swajaldhara programme on 25.12.2002.

##### **Principles of Swajaldhara**

- Adoption of demand responsive, adaptable approach along with community participation based on empowerment of villages to ensure their full participation in the project through a decision making role in the choice of the drinking water scheme, planning, design, implementation, control of finances and management arrangements;
- Full ownership of drinking water assets with appropriate level of Panchayats;
- Panchayats/communities to have the powers to plan, implement, operate, maintain and manage all Water Supply and Sanitation schemes;
- Partial capital cost sharing either in cash or kind including labour or both, 100% responsibility of operation and maintenance by the users;



- An integrated service delivery mechanism;
- Taking up conservation measures through rain water harvesting and ground water recharge systems for sustained drinking water supply;
- Shifting the role of Government from direct service delivery to that of planning, policy formulation, monitoring and evaluation, and partial financial support.

Keeping in view the concept of decentralization of powers, the powers to sanction Swajaldhara projects have now been delegated to District Water & Sanitation Committee (DWSC) as envisaged in the revised guidelines issued in June 2003.

As per the guidelines issued in June 2003, Swajaldhara will have two Dharas. First Dhara (Swajaldhara-I) will be for a Gram Panchayat (GP) or a group of GPs or an intermediate Panchayat (at block/Tehsil level) and the second Dhara (Swajaldhara-II) will have a District as the project area.

#### **Guidelines for environmental safety as per Swajaldhara Projects**

- a. States would need to enact and implement law on effective groundwater extraction control, regulation and recharge
- b. State Government should integrate water conservation and rainwater harvesting schemes with drinking water supply schemes
- c. Rural drinking water, sanitation, health and hygiene programmes need to be integrated at the State, District, Block and GP levels
- d. RPMU/KRWSA should arrange for periodic monitoring and review of the functioning of completed water supply schemes by officers, experts, NGOs, Institutions etc.
- e. Suitable monitoring mechanism and systems may be put in place in this regard by State Government

Funds under Swajaldhara are now allocated to the States/UTs and the allocated amount is intimated to the States/UTs. The States/UTs make district wise allocation and furnish the details to the Department of Drinking Water Supply. On receipt of such information, the funds are released directly to SWSM/DP/DWSM by Department of Drinking Water Supply.

### **2.3 RURAL WATER SUPPLY & SANITATION COVERAGE IN KERALA**

#### **2.3.1 DRINKING WATER SUPPLY COVERAGE**

Water supply, considering its importance in deciding quality of life of people, always has been an area of priority in Kerala's development plans. The importance attached to the sector has increased more in recent years. Introduction of externally aided programmes such as JBIC, Jalanidhi etc and the Tsunami Rehabilitation Programme have significantly enhanced the resources flowing into the sector. In the first three Annual Plans of the XI Five Year Plan, nearly 13 % of the plan outlay flowed into the sector. Even though results appear with a lag, an investment of such magnitude is expected to substantially improve the supply and quality of services in this sector.

In Kerala, 72.77 % of the total population has access to drinking water as at the end of March 2010. The total number of rural people having accessibility to drinking water is 161.60 lakhs, which constitutes 68.55 % of the total rural population. Similarly,



84.80 % of the urban population is covered by water supply schemes and the total number of urban citizens covered is 70.11 lakhs. (Source: Economic Review, 2010)

The increase in the number of citizens covered by water supply schemes during 2009-2010 is 319096. Of this increase, 312695 are in the rural area and 6401 are in the urban area. The district wise details of population covered by water supply schemes in Kerala as on 31-03-2009 are given in **Table 2.2**

**Table 2-2 District Wise Population Covered by Water Supply Schemes**

S.No	District	Rural Population	% of Total Rural Population	Urban Population	% of Total Urban Population	Total Population	% of Total Population
1.	Thiruvananthapuram	1601803	74.76	958617	87.81	2560420	79.16
2.	Kollam	135397	63.01	453781	97.38	1789178	69.21
3.	Pathanamthitta	813091	73.24	107700	87.00	920791	74.62
4.	Alappuzha	1182805	79.00	528255	85.00	1711060	81.13
5.	Kottayam	964558	57.09	292663	97.62	1257221	64.35
6.	Idukki	632423	59.12	55262	95.95	687685	60.90
7.	Ernakulam	1593378	97.83	1393990	94.38	2987368	96.19
8.	Thrissur	1832646	85.85	828354	98.68	2661000	89.47
9.	Palakkad	1468977	64.97	340964	95.62	1809941	69.15
10.	Malappuram	1790729	54.77	353860	99.35	2144589	59.15
11.	Kozhikode	693578	39.01	830762	75.44	1524340	52.94
12.	Wayanad	669798	89.19	14835	50.10	684633	87.70
13.	Kannur	829761	69.37	708332	58.40	1538093	63.85
14.	Kasargod	751235	77.42	143298	61.32	894533	74.29
	<b>Total</b>	<b>16160179</b>	<b>68.55</b>	<b>7010673</b>	<b>84.80</b>	<b>23170852</b>	<b>72.77</b>

Source: Economic Review, 2010

The details of additional population covered with protected water supply are given in **Table 2.3**.

**Table 2-3 Population Covered with Protected Water Supply**

Year	Total population	SC population	ST population
2002-03	468526	36400	13235
2003-04	373155	33584	4105
2004-05	743197	66887	8175
2005-06	160095	15705	1825
2006-07	512261	50202	5840
2007-08	341171	45015	4265
2008-09	226240	19000	2108
2009-10	414817	39488	19580
2010-11 (upto 9/2010)	430596	48284	3608

Source: Economic Review, 2010



### 2.3.2 STATUS OF WATER SUPPLY COVERAGE IN HABITATS

According to the survey conducted by the Rajiv Gandhi National Drinking Water Mission, there were 9776 identified habitats in Kerala. Of these habitats, 1994 habitats were fully covered, 6964 were partially covered, 805 were non-covered and 13 were in forest area during 2001. The present status of these habitats is given in **Table 2.4**.

**Table 2-4 Status of Water Supply Coverage - Habitats**

Month & year	Fully covered	Partially covered	Non covered
March 2001	1994	6964	805
March 2002	2091	6889	783
March 2003	2091	7444	228
March 2004	2125	7638	0
March 2005	2365	7398	0
March 2006	3892	5871	0
March 2007	4745	5018	0
March 2008	5283	4480	0
March 2009	9763	0	0
March 2010	11883	0	0
Sep 2010	11883	0	0

Source: Economic Review, 2010

A fresh habitation survey was conducted in 2003 based on 2001 census population and the number of rural habitations/wards got increased to 12165. The details of another 1124 habitations were further added on 1/4/2007 and the total number of habitations became 13289. Out of this, 1406 habitations are Census Town (CT)/or Out Growth (OG). As per the directions from the government, these CTs and OGs were deleted from the list and the total rural habitations became 11883 only. All these 11883 habitations attained fully covered status as on 12/2008 taking the private wells also into consideration. Details are given in **Table 2.5**. Details of habitations with various schemes are given in **Table 2.6**.

**Table 2-5 Habitation Wise - Quantity of Water Supply**

Quantity of Supply	No. of Habitations (2003 survey) as on 3/2010
Below 10 LPCD or Non-covered	Nil
Between 10 LPCD and 40 LPCD (partially covered)	Nil
Above 40 LPCD (Fully covered)	11883
Non covered Forest Area	Nil
Total Habitations	11883

Source: Economic Review, 2010

**Table 2-6 Scheme Details of Habitations**

S. No	Particulars	State		India	
		No.	%	No.	%
1	Habitations covered by PWSS	8867	74.62	330130	19.91
2	Habitations covered by Hand pumps / Bore wells	209	1.76	579737	34.96



3	Habitations covered by Others	46	0.39	14545	1
4	Habitations Without any Scheme	2761	23.23	733911	44.26
	<b>Total</b>	<b>11883</b>	<b>100</b>	<b>1658323</b>	<b>100</b>

Source: DWSS Website

### 2.3.3 WATER SUPPLY SCHEMES IN OPERATION

Major implementing agencies of drinking water supply schemes in the State are Kerala Water Authority (KWA), Kerala Rural Water Supply and Sanitation Agency (KRWSA) and Local Self Government Institutions (LSGIs). KRWSA and LSGIs are ensuring community participation in the implementation of water supply schemes by sharing the financial costs and taking responsibility in management, operation and maintenance, to some extent. Besides these agencies, Department of Urban Development and Department of Town and Country Planning also act as nodal agencies for water supply schemes under UIDSSMT and JNNURM respectively.

#### a) Kerala Water Authority Schemes

Various schemes are being implemented by Kerala Water Authority considering the need for extending the coverage of protected water supply in the State such as, Centrally Sponsored National Rural Drinking Water Programme (NRDWP) and urban water supply schemes, Technology Mission Schemes, Swajaldhara schemes, schemes with loan assistance from NABARD/Banks, externally aided JBIC Projects (now JICA), ADB and World Bank assisted schemes. State funded water supply schemes are also being undertaken by Kerala Water Authority.

Kerala Water Authority at present has 86 ongoing Accelerated Rural Water Supply Schemes (ARWSS) under various stages of execution- 74 schemes with central fund and 12 schemes with state fund. NC/PC schemes are proposed to provide water supply to not covered/ partially covered areas. 427 schemes under this category have been completed and works of 108 schemes are under various stages of implementation.

The scheme "Varsha" is to collect rain water from the rooftop and store it in a tank. 10% of the project cost has to be borne by the beneficiaries. The project is under implementation in Thiruvananthapuram, Alappuzha, Kottayam and Ernakulam districts. 4457 units of Varsha schemes have been completed and works of 25 units are in progress.

As per the Government of India directive, all the rural schools and Anganwadis having no drinking water facilities are to be provided with such facilities. The expenditure for this purpose should be shared by the Central and State Governments on 50:50 bases from the funds allocated for ARWSP. Kerala Water Authority has provided water supply to 1934 schools so far and works of 80 schemes are under various stages of implementation.

Government of India provides assistance under Technology Mission for implementing schemes in water quality affected areas. Up to 20% of the ARWSP funds are to be earmarked for new projects designed to address water quality issues. Fifteen schemes have been sanctioned so far for a total estimated cost of Rs.14081.00 lakh. The water supply scheme to Kozhinjampara and adjoining villages in Palakkad District and water supply scheme to Uppala in Kasargod District have been completed. Out of 395

Swajaldhara schemes taken up by Kerala Water Authority from 2002-03 to 2006-07, 345 schemes had been completed and remaining works are in the final stage.

➤ *Water Tariff and Revenue*

Information on the water tariff in the State is given in **Table 2.7**. Kerala Water Authority collected revenue of Rs.274.43 crores during 2009-10 as water charges from various urban and rural water supply schemes. The income from water charges has increased by 38.69% when compared to the income of Rs.197.87 crores during 2008-09. 77.29% of the total water charges collected during 2009-10 was from domestic, non domestic and industrial consumers and 22.71% was collected from local bodies by way of street tap connections. The details of income collected from water charges are given in **Table 2.8**.

Table 2-7 Water Tariff

Type of Connections	Tariff from 01/09/2008
A. Domestic	
Upto 5000 L	Rs. 20/-
5000 to 10000 L	Rs. 20/- plus @ Rs. 4.00 per every 1000 L in excess of 5000 L.
10000 to 20000 L	Rs. 40/- plus @ Rs. 5.00 per every 1000 L in excess of 10000 L.
20000 to 30000 L	Rs. 90/- plus @ Rs. 6.00 per every 1000 L in excess of 20000 L.
30000 to 40000 L	Rs. 150/- plus @ Rs.10.00 per every 1000 L in excess of 30000 L.
40000 to 50000 L	Rs. 250/- plus @ Rs. 14.00 per every 1000 L in excess of 40000 L.
Above 50000 L	Rs. 390/- plus @ Rs. 25.00 per every 1000 L in excess of 50000 L.
B. Non Domestic	
Upto 15000 L	At the rate of Rs.10/- per 1000 L and Rs. 125/- minimum charge.
15000 to 50000 L	Rs.150/- plus @ Rs.14.00 per every 1000 L in excess of 15000 L.
Above 50000 L	Rs.640/- plus @ Rs.25.00 per every 1000 L in excess of 50000 L.
C. Industrial	
For consumption in a month	At the rate of Rs.25/- per 1000 L and Rs. 250/- minimum charge.
D. Local Bodies	
Municipal Taps	Rs. 5256/- per year
Panchayat Taps	Rs. 3500/- per year

Source: Economic Review 2009

Table 2-8 Income from Water Charges

Year	Urban Schemes				Rural Comprehensive Schemes			Rural Single Panchayat Schemes			Grand Total		
	Domestic, Non-domestic & Industrial	Street Taps	Total		Domestic, Non-domestic & Industrial	Street Taps	Total	Domestic, Non-domestic & Industrial	Street Taps	Total	Domestic, Non-domestic & Industrial	Street Taps	Total
2000-01	4389	1393	5782		1097	1030	2127	549	894	1443	6035	3317	9352
2001-02	5184	1011	6195		1296	748	2044	643	649	1297	7128	2408	9536
2002-03	5633	1190	6823		1408	880	2288	704	763	1467	7745	2833	10578
2003-04	6030	1370	7400		1520	1012	2532	759	877	1636	8309	3259	11568



Year	Urban Schemes			Rural Comprehensive Schemes			Rural Single Panchayat Schemes			Grand Total		
	Domestic, Non-domestic & Industrial	Street Taps	Total	Domestic, Non-domestic & Industrial	Street Taps	Total	Domestic, Non-domestic & Industrial	Street Taps	Total	Domestic, Non-domestic & Industrial	Street Taps	Total
2004-05	8132	133	8265	2051	98	2149	1023	86	1109	11206	317	11523
2005-06	7695	986	8681	1930	4052	5982	979	1015	1994	10604	6053	16657
2006-07	8733	311	9044	2183	1123	3306	1213	293	1506	12129	1727	13856
2007-08	8588	1074	9672	2150	794	2944	1075	689	1764	11823	2557	14380
2008-09	12031	1363	13394	3008	1007	4015	1504	874	2378	16543	3244	19787
2009-10	15426	2618	18044	3857	1935	5792	1928	1679	3607	21211	6232	27443

Source: Economic Review 2010

**b) Bank Assisted Projects**

Certain viable projects originally taken up with LIC/HUDCO assistance were posed for availing term loan from banks for completion. The Adhoc Augmentation of Kochi Water Supply Scheme, taken up with Bank assistance was completed and inaugurated on 5th October 2007. The Chowara Scheme taken up using bank aid has already been commissioned. Bank loan is also being availed for implementing water supply scheme to Thrissur and adjoining Panchayats and is partially completed during 2009 (Thrissur portion). The scheme is expected to be completed by first half of 2010-11.

**c) NABARD Assistance**

There were eight rural water supply schemes costing Rs. 4868.33 lakh sanctioned under RIDF IX of NABARD for implementation with NABARD loan assistance. Total loan sanctioned was Rs.4444.61 lakh. Out of the eight schemes, five schemes were completed and remaining three schemes were scheduled for completion shortly. Thirty six rural drinking water supply schemes have been sanctioned by NABARD under RIDF XIV. Major portion of these schemes were LIC aided schemes which were held up due to shortage of funds. It is proposed to implement these schemes through fast track mechanism since these schemes will have to be completed within the stipulated time specified by NABARD. Of these, 5 schemes are completed, one is partially commissioned in 2010, 11 schemes are targeted for commissioning by 9/2011 and 19 targeted for completion in 2011-12.

**d) JBIC Assisted Kerala Water Supply Project**

The JBIC assisted project envisages the implementation of five water supply projects in Thiruvananthapuram, Cherthala, Meenad, Kozhikode and Pattuvam for a total estimated cost of Rs.1787.45 crores. The project cost has been revised to Rs.2987.40 Crores during 2009. The total project has been proposed to be carried out in 23 contract packages of which 11 are International Competitive Bidding (ICB) packages and 12 are Local Competitive Bidding (LCB) packages. Twenty one work contract





packages were awarded and the construction activities are progressing. The remaining two contract packages are the Rehabilitation works of existing components of Thiruvananthapuram and Kozhikode schemes. Institutional strengthening is also included in the project. The overall achievement of the scheme is given in **Table 2.9**.

**Table 2-9 Overall Physical Achievement of JBIC Project**

Schemes	% completion of construction works as on 30.06.2009	Expected population benefited
Thiruvananthapuram Scheme	61%	10.70 lakh
Maenad Scheme	67%	5.26 lakh
Cherthala Scheme	64%	6.53 lakh
Kozhikode Scheme	52%	13.02 lakh
Pattuvam Scheme	51%	5.30 lakh

Source: Economic Review, 2009

**e) ADB Assisted Long Term Works under TEAP**

The Long Term works proposed under TEAP (Tsunami Externally Aided Project) are (1) CWSS to Alappad, Clappana, Oachira and Karunagappally and (2) WSS to Kayamkulam Municipality and Arattupuzha Panchayath. These works are carried out in three packages. The works of the three packages have been completed and trial running is in progress.

**f) World Bank Aided Jalanidhi Project**

Jalanidhi project was initially approved at an estimated cost of Rs.451.00 crores and targeted to cover 80 Gram Panchayats for improving the quality of rural water supply and environmental sanitation service delivery to achieve sustainability of investments. After its midterm review, the project cost was revised to Rs.381.50 crore since impressive achievements were attained with a lower cost than the estimated.

Ninety two Gram Panchayats spread over Thrissur, Palakkad, Kozhikode and Malappuram Districts and 18 Panchayats spread over the remaining nine districts excluding Alappuzha @ 2 Gram Panchayats per District on experimental basis have been covered under the project. Besides, two Gram Panchayats of Kollam District were selected to implement Tsunami rehabilitation water supply project. Thus, Jalanidhi Project is covering 112 Gram Panchayats through 122 projects. Of these projects, ten are tribal projects.

There are 3712 water supply schemes managed by 4095 active beneficiary groups as on 31-10-2009. 52 per cent of the total Jalanidhi membership is from families living below the poverty line (BPL) and 16 per cent from SC/ST households. 5.07 lakh people are benefited by the construction of latrines through Jalanidhi Project. The benefit of newly constructed EMP units reached 2.46 lakh populations. Besides large number of people were trained on various sanitation and hygiene practices, project management and skill development trainings.

Out of the 3712 schemes taken up under Jalanidhi programme, 3707 water supply schemes have already been completed and communities have been empowered for its operation and maintenance. All the functional water supply schemes are operated

and maintained by the beneficiary groups. As on 30-09-2010, about 10.14 lakh people are getting water through Jalanidhi schemes (170253 households and 175 institutions). Ninety five KWA single Panchayat schemes and 253 Gram Panchayat schemes were rehabilitated and handed over to the beneficiary groups. Of the commissioned schemes, 162 are in tribal areas benefiting about 35000 tribes (6755 households).

Three types of water supply schemes have been undertaken by Jalanidhi, (a) small schemes (b) comprehensive schemes (c) Tsunami Rehabilitation Schemes. Of the technologies adopted, dug wells are seen to be the most popular, followed by bore wells and rain water harvesting. It is worthwhile to note that 12 % of the Jalanidhi schemes are using rain water as the main source for water supply and it could have a considerable impact on Government of Kerala's initiative to promote rain water harvesting in a big way. Out of the pending five schemes, two are small schemes, one Tsunami rehabilitation scheme and two are comprehensive schemes.

*g) Tsunami Rehabilitation Programme (TRP)*

Kerala Water Authority has been allotted Rs.75.00 Crores as grant from Government of India towards the implementation of Tsunami Rehabilitation Programme. Accordingly, administrative sanction has been issued to 115 schemes amounting to Rs.7087.57 lakhs in the Tsunami affected areas covering nine Districts namely, Kasargod, Kannur, Malappuram, Kozhikode, Thrissur, Ernakulam, Alappuzha, Kollam and Thiruvananthapuram. Details are given below in **Table 2.10**.

**Table 2-10 Tsunami Rehabilitation Programme**

S.No	District	Number of Schemes	Total Estimates (Rs. Lakhs)
1	Kasargod	3	663.00
2	Kannur	8	1479.00
3	Malappuram	2	110.00
4	Kozhikode	10	549.00
5	Thrissur	3	300.00
6	Ernakulam	19	963.34
7	Alappuzha	10	852.00
8	Kollam	19	1467.80
9	Thiruvananthapuram	41	703.43
<b>Total</b>		<b>115</b>	<b>7087.57</b>

*Source: Economic Review, 2009*

**2.3.4 SANITATION**

*a) Malinya Muktha Keralam*

Historically, Kerala has been ahead of other States in the country in providing sanitation facilities but now the assimilative capacity of environment in Kerala is fast declining due to inadequate attention to environment in general and sanitation in particular. Thus, sanitation has emerged as a critical component in the sustainability of Kerala's attainments. Therefore, it is felt essential to step up the social and infrastructural interventions in the State. Recognizing the past responses in the sector and based on the current status and emerging issues in various components of

sanitation, an integrated action plan has been drawn up namely '**Malinya Mukta Keralam Action Plan**' for a comprehensive intervention. The Action Plan, which was released by Her Excellency, the President of India on **November 1, 2007** put forward an overall strategy, organizational reform and specific action plans with time-frame and outputs. Accordingly, the action plan envisaged the following outputs to be achieved.

- Total coverage of household sanitary latrines in nine months
- Total coverage of sanitary latrines in public institutions, schools, hospitals etc in one year
- Systematizing household and institutional waste treatment systems within three years
- Popularizing the segregation of household and institutional waste within one year
- Developing decentralized common waste treatment facilities within three years
- Developing common sanitary land-fill sites for inert waste during the 11th plan period
- Making colonies clean and neat within two-years
- Making public places litter-free within three-years
- Preparation of a perspective plan for liquid waste management within two years
- Extending sewerage facilities and triple the coverage within five years

In order to encourage the implementation of the action plans, the local governments, schools, anganwadi, hospitals and public offices will be given awards based on transparent indicators. During 2008, the activities in sanitation sector have been stepped up in accordance with the objectives. The campaign and interventions taken up as part of the action plan to observe one dry day every week to get rid of stagnant water in the household premises and public places and also cleaning the drains and public places are believed to have controlled the spread of vector-borne diseases, to a large extent during 2008. Another major initiative taken up under the campaign was to regulate the use of plastic carry bags with thickness less than 30 micron. As part of the enforcement measures, the Urban Local Bodies have confiscated 245 Lakhs banned plastic carry bags (36.4 tonnes) and charged a fine of Rs.11.88 Lakhs.

#### **b) Solid Waste Management**

There has been significant importance given to implement the Municipal Solid Waste (Management & Handling) Rules, 2000 which envisages segregated storage of waste at source, collection from source, protected transportation to the treatment facility, establishment of environmentally safe treatment system and its operation and maintenance and safe disposal of inert rejects. A sectoral status study on MSW management in Kerala, undertaken with the support of WSP- South Asia in 2007, indicated that the total MSW generation in the state is about 8300 TPD. These studies indicated that 70-80% of the total waste generated is biodegradable in nature and these putrescible waste needs to be managed within 24 hours. 13% of the waste is generated by the five City Corporations, 23% by the 53 Municipalities and the rest by the 999 Gram Panchayats. The details of waste generated are given in **Table 2.11**.

**Table 2-11 Municipal Solid Waste Generated in Kerala**

Local Governments	Population 2001	Per capita waste generation (g/day)	Waste generation per day(T)	
			2001	2006
5 City Corporations	2456618	400	983	1091
53 Municipalities	5810307	300	1743	1935
999 Gram Panchayats	23574449	200	4715	5312
<b>Total</b>			<b>7441</b>	<b>8338</b>

Source: Suchitwa Mission website

The five City Corporations and 49 Municipalities and 44 Gram Panchayats are being supported for establishing full-fledged integrated MSW management facility with financial support from the plan allocation to the State and the Local Governments, funds under the Jawaharlal Nehru National Urban Renewal Mission (JNNURM), Urban Infrastructure Development Scheme for Small and Medium Towns (UIDSSMT) and Kerala Sustainable Urban Development Project (KSUDP) and own fund mobilized by the Local Governments. Efforts are also taken to establish solid waste treatment systems in hotspots of 226 urbanized Gram Panchayats by making use of the funds under Total Sanitation Campaign for the purpose of solid and liquid waste management to the tune of about Rs.2000 Lakhs.

The preliminary projects for solid waste management in 49 Municipalities and 44 Gram Panchayats with an outlay of Rs.5362 Lakh have been approved and a State level support of Rs.1919 Lakh has been extended. So far 18 Municipalities and 28 Gram Panchayats have completed the installations and rest is in progress. In addition, Rs.8800 Lakhs has been earmarked under JNNURM, Rs.2429 Lakhs under UIDSSMT and Rs.3294 Lakhs under KSUDP for solid waste management for City Corporations.

The MSW (Management & Handling) Rules, 2000 makes the disposal of final rejects from the waste treatment plant in an Engineered Land Fill (ELF) a mandatory requirement. If each Municipality ventures for establishing ELF separately, it would require large tract of land having no environmental constraints. Therefore, Regional ELF is suggested for tackling the requirement. A comparative study on the land and cost requirement of individual ULB-based ELF and Regional ELF are given below. Accordingly, six regional ELFs are proposed for the 14 districts and a feasibility of establishing one regional engineered landfill facility has been initiated during the current year.

#### c) Liquid Waste Management

The coverage of sewerage facilities, even in the City Corporations, is extremely low, of the order of 30% in Thiruvananthapuram and 5% in Kochi Corporation areas, probably one of the lowest in the country. Even in this system, the provision for treating the black liquor is almost absent. Rest of the Municipal and rural areas do not have even such a facility. Due to land constraints the septic tanks have volume constraints and due to high water table scenario, the leach pits overflow, especially during rainy season which extend up to about 150 days in a year. Therefore, there is a requirement of clearance and removal of septage, the facilities for which are not available anywhere in the State. The practice now is to collect the septage using vacuum suction into tankers

which are then emptied into open spaces and even water bodies, one of the most dangerous practices

**d) Communication and Capacity Development Unit**

The Government of India has sanctioned a CCDU specifically for sanitation sector with the objectives to develop State specific information, education and communication strategy and provide capacity development of functionaries at all levels at a total cost of Rs. 114.7 Lakh. The state has housed the CCDU in Suchitwa Mission which started functioning since June 2008.

The objective of CCDU is to develop communication strategies for reform initiatives in sanitation sector and also to provide capacity development of functionaries at all levels. The unit is to provide IEC/HRD support to State Suchitwa mission and districts. It will provide HRD/IEC inputs to all TSC projects and also to Malinya Muktha Kerala. The CCDU will also document successful IEC/HRD initiatives in the State and disseminate the same among functionaries at different levels.

**e) Nirmal Gram Puraskar**

The Government of India instituted this award scheme in 2003 (operational since 2005) for recognizing, encouraging and facilitating the Panchayat Raj Institutions, individuals and organizations to promote and achieve total sanitation. The NGP is awarded to Gram Panchayats having total coverage of toilets in houses, school and anganwadi, open defecation free status and clean and neat environment. The award is also extended to the Block Panchayats as well as District Panchayats. So far, 83% of the Gram Panchayats in Kerala has received the award. The number of local governments that received the award so far is given below in **Table 2.12**.

**Table 2-12 Nirmal Gram Puraskar Awards to Local Governments**

Year	District Panchayats	Block Panchayats	Gram Panchayats
2005	-	-	1
2006	-	-	6
2007	-	6	219
2008	4	90	600
Total	4	96	826

Source: Suchitwa Mission Website

**2.4 REGULATORY AND POLICY FRAMEWORK**

The proposed Jalanidhi-2 project will address all the issues of concern as laid down in the OD 4.01 of World Bank on EA. Though there are no specific clearances required from the Ministry of Environment, GOI, all the provisions in the various Central and State Acts listed in this chapter and relevant in the context of the proposed project would be incorporated during the implementation of the project. The World Bank Safeguard Policies are indicated in **Table 2.13**.

**Table 2-13 World Bank Safeguard Policies**

Policy	Key Features	Applicability to this project
OP/BP 4.01 Environmental	Potential environmental consequences of projects identified early in project	Applicable to this project. The EMF includes a details description of

Policy	Key Features	Applicability to this project
Assessment	cycle. EAs and mitigation plans required for projects with significant environmental impacts or involuntary resettlement. EAs should include analysis of alternative designs and sites, or consideration of "no option" Requires public participation and information disclosure before Board approval	assessment procedures for each of the activities proposed under the Jalanidhi project. Screening and assessment tools as well as detailed guidelines have been developed for all proposed schemes.
OP/BP 4.04 Natural Habitats	Prohibits financing of projects involving "significant conversion of natural habitats unless there are no feasible alternatives". Requires environmental cost benefit analysis. Requires EA with mitigation measures.	Applicable, if the schemes to be taken up under the project are located near natural habitats. However, assessment procedures and mitigation measures have been put into place through the EMF so that any negative impacts on the natural environment are minimized.
OP/BP 4.36 Forestry	Prohibits financing for commercial logging operation or acquisition of equipment for use in primary moist tropical forests.	Some of the schemes taken up under the project will be located in forest areas. Mitigation measures have been appropriately included into the Environmental Management Framework (EMF) to ensure that in all schemes which have a component located on forest land. The required permission is taken through the Forest Department (for approval of the Government of India under the Forest Conservation Act, 1980). Also, any required felling of trees in forest or non forest areas is done with the permission of the Forest Department and in accordance with guidelines for compensatory afforestation.
OP 4.09 Pest Management	Supports environmentally sound pest management, including integrated pest management, but does not prohibit the use of highly hazardous pesticides. Pest Management is the borrower/s responsibility in the context of a project's EA.	<b>NOT Applicable.</b> vector control measures, if undertaken in the project will be in accordance with the OP 4.09 avoiding use of insecticides in classes 1a, 1b and 2
OP/BP 4.12 Involuntary Resettlement	Implemented in projects which displace people. Requires public participation in resettlement planning as part of EA for projects. Intended to restore or improve income earning capacity of displaced	Applicable to the projects. The project will ensure that people are not displaced as far as possible. Schemes components will be sited as far as possible on Government or Panchayat lands.

Policy	Key Features	Applicability to this project
	populations.	Resettlement Policy Framework has been prepared separately. Involuntary acquisition will be avoided.
OP/BP 4.20 Indigenous Peoples	Purpose is to ensure indigenous peoples benefit from Bank financed developed and to avoid or mitigate adverse affects on indigenous peoples. Applies to projects that might adversely affect indigenous peoples or when they are targeted beneficiaries. Requires participation of indigenous peoples in creation of "indigenous people development plans"	Applicable to the project. Adverse effects on the indigenous people will be avoided. Indigenous people will be benefited with access to water supply and sanitation.
OP/BP 4.11 Physical Cultural Resources	Purpose is to assist in the preservation of cultural property, such as sites having archeological, paleontological, historical, religious and unique cultural values. Generally seeks to assist in their preservation and avoid their elimination. Discourages financing of projects that will damage cultural property.	Not Applicable to the project. No existing cultural property will be damaged. However, any cultural relics if found during any excavation during the project works will be deposited with the relevant Government authority whose recommendation regarding further excavation will also be taken.
OP/BP 4.37 Safety of Dams	Applies to large dams (15 meters or more in height). Requires review by independent experts throughout project cycle. Requires preparation of EA and detailed plans for construction and operation, and periodic inspection by the Bank.	Not applicable since the project does not involve construction of dams.
OP/BP 7.50 Projects on International Waterways	Covers riparian waterways that form boundary between two or more states, as well as any bay, gulf, strait or channel bordered by two or more states. Applies to dams, irrigation, flood control, navigation, water, sewage and industrial projects. Requires notification, agreement between states, detailed maps, and feasibility surveys.	Not applicable since the project area does not involve international waterways.
OP/BP 7.60 Projects in Disputes Areas	Applies to projects where there are territorial disputes present. Allows Bank to proceed if governments agree to go forward	Not applicable as no project components will be proposed in disputed areas.

Policy	Key Features	Applicability to this project
	without prejudice to claims. Requires early identification of territorial disputes and description in all Banks documentation.	

**2.4.1 NATIONAL FRAMEWORK**

Rural water supply is a state subject under the Constitution of India. However, States are guided by policies and regulations enunciated by the Government of India. These include:

- 73rd Constitutional Amendment in 1993.
- The National Water Policy of 2002
- The Environment (Protection) Act, No.29 of 1986
- Water (Prevention and Control of Pollution) Act, 1974 (Central Act 6 of 1974) as amended in 1988
- Water (Prevention and Control of Pollution) Cess Act No 36 of 1977
- Forest (Conservation) Act No. 69 of 1980 as Amended in 1988
- The Wildlife (Protection) Act 1972 as Amended in 1991
- EIA Notification of 2006 with amendments in 2009

The 73rd Constitutional Amendment designates Panchayat Raj Institutions as providers of basic services to rural communities which include drinking water and sanitation. The aspects of the National Water Policy that impact rural water supply schemes are presented in the **Box**.

<b>National Water Policy aspects impacting Rural Water Supply Schemes</b>
<ul style="list-style-type: none"> <li>• Water is a scarce and precious national resource to be planned, developed and conserved as such and on an integrated and environmentally sound basis, keeping in view the needs of the States concerned.</li> <li>• Water should be made available to water short areas by transfer from other areas including transfers from one river basin to another, based on a national perspective, after taking into account the requirements of the areas/ basins.</li> <li>• Water resource development projects should, as far as possible, be planned and developed as multipurpose projects. Provision for drinking water should be a primary consideration. The projects should provide for irrigation, flood mitigation, hydro-electric power generation, navigation, pisciculture and recreation wherever possible.</li> <li>• The study of the impact of a project, during construction and later, on human lives; settlements, occupations, economic and other aspects should be an essential component of project planning.</li> <li>• In the planning, implementation and operation of projects, the preservation of the quality of environment and the ecological balance should be a primary consideration. The adverse impact, if any, on the environment should be minimised and should be off-set by adequate compensatory measures.</li> <li>• There should be an integrated and multi-disciplinary approach to the planning, formulation, clearance and implementation of projects, including catchment treatment and management, environmental and ecological aspects, the rehabilitation of affected people and command area development.</li> <li>• Special efforts should be made to investigate and formulate projects either in or for the benefit of areas inhabited by tribal or other specially disadvantaged groups such as Scheduled Castes and Scheduled Tribes. In other areas also, project planning should pay special attention to the needs of Scheduled Castes and Scheduled Tribes and other weaker sections of society.</li> <li>• In the planning and operation of systems, water allocation priorities should be broadly as follows: (i) Drinking water, (ii) Irrigation, (iii) Hydro-power, (iv) Navigation and (v) Industrial and other uses. However, these priorities might be modified, if necessary, in particular regions with reference to area specific considerations.</li> </ul>





The scope of relevant national environment regulations listed above is presented in Table 2.14.

Table 2-14 Scope of National Environmental Regulation

S.No	Relevant Act	Scope of the Act	Implication for the EMF
1.	The Wildlife (Protection) Act 1972, Amendment 1991	This Act provides for protection to listed species of Flora and Fauna in the declared network of ecologically important protected areas such as wild life sanctuaries and National parks.	Kerala has about 53 designated natural habitats and they are protected by National and State regulations. These include 2 Biosphere Reserves, 5 National Parks, 17 Wildlife/Bird Sanctuaries, 1 Community Reserve, 2 Tiger Reserve and 28 Mangrove Sites. Details are given in Annexure-2. Activities pertaining to water supply in the above said areas are to be restricted.
2.	Water (Prevention and Control of Pollution) Act, 1974 (Central Act 6 of 1974) as amended in 1988	This Act prohibits the discharge of pollutants into water bodies beyond a given standard and lays down penalties for non-compliance.	Treatment and disposal of wastewater generated from the communities must meet the standards prescribed by the regulatory authorities.
3.	Ramsar Convention, 1975	This is an international treaty for conservation and sustainable utilization of wetlands	Any scheme near Vembanad, Asthamudi and Sasthamkotta lakes are to be implemented with care to protect these lakes against contamination.
4.	Water (Prevention and Control of Pollution) Cess Act No 36 of 1977	This Act provides for a levy and collection of a cess on water consumed by industries and local bodies.	Water extraction from ground or surface water bodies will be at a cost as per regulatory authorities i.e. KSPCB.
5.	Forest (Conservation) Act No. 69 of 1980 and amendment in 1988	This Act restricts the powers of the State in respect of de-reservation of forests and use of forestland for non forest purposes.	This Act restricts the powers of the State in respect of de-reservation of forests and use of forestland for non forest purposes. Almost 29% of the State is under forest cover. The forest cover is mainly confined to about five districts which are away from the coast.

S.No	Relevant Act	Scope of the Act	Implication for the EMF
			Therefore care will be taken so that the impact on these areas from the water supply and sanitation components of the project is not likely to adversely affect the forests with respect to the ecology and health of the forests, nor the welfare and rights of the people residing in the forests, nor the management structures for protection and conservation of the forests. Clearance is to be obtained from the Forest Department when forest land is required for the project activities.
6.	National Wetland Conservation Programme (NWCP) 1985-86 updated 2009	Conservation of wetlands in the country so as to prevent their further degradation and ensuring their wise use for the benefit of local communities and overall conservation of biodiversity.	Implementation of schemes under Jalanidhi-2 near Vembanad, Asthamudi, Sasthamkotta, Kottuli and Kadalundi wetlands should not affect them.
7.	The Environment (Protection) Act, No.29 of 1986	Under this Act, the central government is empowered to take measures necessary to protect and improve the quality of the environment by setting standards for emissions and discharges; regulating the location of industries; management of hazardous wastes, and protection of public health and welfare.	Water supply projects in coastal areas will require CRZ clearance.
8.	The Municipal Solid Wastes (Management and Handling) Rules, 2000.	Every municipal authority shall, within the territorial area of the municipality, be responsible for the implementation of the provisions of these rules, and for any infrastructure development for collection, storage, segregation, transportation, processing	Municipal Solid Waste generated in a city or a town shall be managed and handled in accordance with the criteria and the procedures laid down in Schedule II of Municipal Solid Waste (Management and Handling) Rules, 2000. The waste processing and the

S.No	Relevant Act	Scope of the Act	Implication for the EMF
		and disposal of municipal solid wastes.	disposal facilities to be set up by the municipal authorities on their own or through an operator of a facility shall meet the specifications and standards as specified in Schedules III and IV of Municipal Solid Waste (Management and Handling) Rules, 2000.
9.	EIA Notification of September 2006 with Amendment in December 2009	All projects listed under Category A of the Notification require environmental clearance from the MoEF, Gol. Water supply and sanitation projects, however, are not covered in the Schedule.	The proposed Jalanidhi - 2 project does not fall under any of the project categories listed in Schedule-I of the Environmental Impact Assessment Notification and hence does not require any formal environmental clearance of the MoEF, Gol. However, the EMF is designed to ensure that environmental safeguard measures are integrated into the project. However, sanitation projects like municipal solid waste management need Environmental Clearance from the regulatory authorities.
10.	CRZ Notification Ministry of Environment and Forests Gazette of India, Part-II, Section 3, Sub-section (ii) of dated the 6th January, 2011.	The following activities in CRZ shall be regulated as follows, namely:- (i) Within 50mts from the HTL of the backwater islands existing dwelling units of local communities may be repaired or reconstructed. However, no new construction shall be permitted; (ii) Beyond 50mts from the HTL on the landward side of backwater islands, dwelling units of local communities may be constructed with the prior permission of the GP.	No component of Jalanidhi - 2 scheme will be allowed within 50 m from the HTL of the Backwater islands. Beyond 50 m from the landward side schemes can be taken up with GP approval.

The proposed Jalanidhi - 2 project does not fall under any of the project categories listed in Schedule-I of the Environmental Impact Assessment Notification and hence does not require any formal environmental clearance of the MoEF, GoI. The project area has not been notified as ecologically sensitive or fragile under the Environment Protection Act, 1986.

#### 2.4.2 STATE FRAMEWORK

Water supply and sanitation in Kerala is guided by the following state laws presented in **Table 2.15**.

**Table 2-15 Scope of State Environmental Regulations**

S.No	Relevant Act	Scope of the Act	Implication for the EMF
1a	Kerala Water (Prevention and Control of Pollution) Rules, 1976.	This Rule enables for a levy and collection of a cess on water consumed by industries and local authorities.	Collection of a Cess on water consumed by industries and local authorities
1b	The Water (Prevention and Control of Pollution) Cess Act, 1977	This Act provides for the levy and collection of Cess and water consumed by persons carrying on certain industries and by local authorities, with a view to augment the resources of Central Board and the State Boards for prevention and control of water pollution	Water extraction from ground or surface water bodies will be at a cost as per regulatory authorities
2	Kerala Water Supply and Sewerage Act, 1986 (Amendment in 2008)	An Act to consolidate and amend the laws relating to water supply, control over water supply, Manufacture and marketing of packaged drinking water, mineral water etc, Punishment for illegal use of public hydrants, Provision of water meters, New premises not to be erected without drains, Work relating to sewer to be done by Licensed Plumber and as per specifications etc.	The proposed Jalanidhi - 2 project Should follow the Kerala Water Supply and Sewerage Board guidelines.
3	Kerala Panchayat Raj Act, 1994 (Amendment in 2007)	As per the Act, a number of powers and responsibilities and projects of the Government were transferred to the local self-governments with effect from October 2, 1995. Along with them, the service of the concerned officers was transferred to the local self-government bodies.	All decisions regarding the environmental action plan have to be endorsed by the village Water Supply and Sanitation Committee which is a legal body under the Gram Panchayat.



S.No	Relevant Act	Scope of the Act	Implication for the EMF
4	Kerala Ground Water (Control & Regulation) Act 2002	An Act to conserve the Ground water for the regulation and control of its extraction and use in the State such as Notifying areas for the control and regulation of ground water development, grant of permit for extraction and use of ground water, registration of existing wells of notified area, funding of ground water authority etc.	The proposed Jalanidhi-2 project should follow the Kerala Ground Water Authority regulation for the extraction of ground water, if any.
5	The Kerala Irrigation and Water Conservation Act, 2003 (Amendment in 2006)	An Act to consolidate and amend the laws relating to construction of irrigation works, conservation and distribution of water for the purpose of irrigation and levy of betterment contribution and water cess on lands benefited by irrigation works in the State of Kerala and to provide for involvement of farmers in water utilization system and for matters connected therewith or incidental thereto.	Not Applicable.
6	Kerala Municipality Building (Amendment) Rules, 2004	Unless otherwise stipulated specifically in a town Planning Scheme, workable rooftop rainwater harvesting arrangements shall be provided as an integral part of all new building constructions for the following occupancies, namely:- i) Group A1 Residential (with floor area of 100 sq.m or more and plot area of 200 sq.m or more) ii) Group A2 Special Residential iii) Group B Educational; iv) Group C Medical/Hospital v) Group D Assembly vi) Group E Office/Business vii) Group G1 and Group G2 Industrial (only for Workshops, Assembly plants, Laboratories, Dry cleaning plants, Power plants, Gas Plants, Refineries, Diaries, Food Processing Units and any other occupancies notified by the Government from time to time.	Applicable to Jalanidhi - 2
7	Kerala Water Policy, 2008	The Policy recognizes that water is a prime natural resource and a basic	Applicable to Jalanidhi - 2

S.No	Relevant Act	Scope of the Act	Implication for the EMF
		<p>human need. The policy emphasizes the need to estimate water resources and plan their allocation and utilization so that human consumption gets the first priority over agriculture, industry and power generation. The main objectives are</p> <ul style="list-style-type: none"> <li>• Adopt integrated and multi-sectoral approach for planning, development and management of water resources</li> <li>• Consider micro watersheds as the basic unit for the conservation and optimal utilization of water resources for achieving resource sustainability.</li> <li>• Integrate the problems and prospects of water resource systems by considering river basin as the basic unit.</li> <li>• Emphasize the importance of comprehensive watershed conservation and management plan, water quality management plan, long term sub basin and river basin operation and monitoring plan and state water resource plan.</li> <li>• Enable appropriate Institutional mechanism and legal measures for sustainable water resource development and management.</li> </ul>	
8	Kerala State Environmental Policy - 2009	The exceptional nature of Kerala with a high literacy rate, its unique economic, social, political and cultural ethos and high density of population contribute to pressures on the environment. The alarming consequences of this pressure are becoming increasingly evident and utmost care has to be taken to see that the demand on the environment does not exceed its carrying capacity for the present as well as future generations. The Environmental Policy reflects all these serious issues affecting us and	Applicable to Jalanidhi - 2

S.No	Relevant Act	Scope of the Act	Implication for the EMF
		<p>our life support systems. The objectives are</p> <ul style="list-style-type: none"> <li>• Ensure conservation of resources</li> <li>• Ensure equitable access and sustainable use of resources</li> <li>• Optimise the efficiency in environmental resource use</li> <li>• Promulgate guidelines and policies for waste disposal</li> <li>• Integration of environmental concerns in economic and social development</li> <li>• Environmental governance</li> <li>• Enhancement of resources for environmental conservation</li> <li>• Create environmental awareness for the society.</li> </ul>	
9	GO (Rt) No. 3682/05/LSGD	The Government vide G.O referred above have permitted the mission to organize intensive awareness campaign through various Government, Non Government, Social organizations.	Applicable to Jalanidhi - 2
10	G.O. (Rt) 1961/05/LSGD	The Local Self Government Institutions (LSGIs) are permitted to entrust the Integrated Solid Waste Management Scheme to anyone of the service providers approved and enlisted by the Government of Kerala in their respective fields.	Applicable to Jalanidhi - 2
11	GO(Rt) No. 2246/09/LSGD	Government of Kerala has appointed Suchitwa Mission as the Nodal Agency for advising Government on establishing Slaughter houses of appropriate size for the use of groups of Panchayats and to render Technical support to the Local Self Government Institutions.	Applicable to Jalanidhi - 2 to the extent of disposal of liquid and solid wastes arising from slaughter houses.

## 2.5 SECTOR INSTITUTIONS

Kerala has one nodal department for rural water supply and sanitation, while four other Institutions have a converging impact on water supply and sanitation. These institutions are as under:

### 2.5.1 DEPARTMENT OF WATER RESOURCES

- The main purpose of the Department is to formulate State water policy fixing of water rates and integrated Irrigation Bill and also an Integrated Water resources Development plan for Kerala for irrigation, drinking water and electricity
- Maintenance of the completed projects, prepare Irrigation projects and execute them in time within the prevailing rules and regulations for the benefit of the people of the State. The Department is having plan schemes and Non-plan schemes. Plan schemes are either centrally sponsored or externally aided schemes
- The Water Resources Department is the agency that investigates, designs, constructs, operates and maintains, minor, medium and major Irrigation Projects, Flood control works on river banks, coastal protection works, inland navigation, hydrological information system collection, drainage works, salinity extrusion and land reclamation works, engineering research, coastal engineering, field studies etc., based on suitable budget provisions
- The Command Area Development Works on irrigated commands of the state under CADA programme for the completed projects
- The renewal of PAP Agreements with Tamil Nadu by JWR and settle interstate water disputes through Cauvery cell at New Delhi.

#### ➤ Major Activities

- Conducting Investigation of projects and prepare project reports for implementation for the benefit of the people
- Implementation of the Irrigation projects after investigation
- Operation and maintenance of the projects for the sustainable development through Project Advisory Committees of each project
- Make the Irrigation system reliable, predictable and equitable involving users, planners and policy makers
- Conducting sedimentation surveys in reservoirs and water resources surveys to monitor river water quality
- Monitoring and Evaluation of the Irrigation Projects using remote Sensing Technique.
- Conducting Model studies for Reservoirs, dams, Spillways etc., and also soil surveys for investigation of projects and coastal Engineering, Field Studies
- To disseminate knowledge about the availability of water and its utilization to the general public
- To assist other departments and the general public in preparing water utilization projects



### 2.5.2 KERALA RURAL WATER SUPPLY AND SANITATION AGENCY

Kerala Rural Water Supply and Sanitation Agency (KRWSA) have been promoting mainly Small water supply schemes and a few large surface based water supply schemes in the rural villages for the last 10 years. The project also lays emphasis for the transfer of existing single Panchayat piped water supply schemes (currently owned and managed by Kerala Water Authority, KWA) to Gram Panchayats (GPs) and then to Beneficiary Groups (BGs) for the future operation and maintenance, as per the new Government of Kerala (GoK) policy. So far KRWSA has taken up 3696 small water supply schemes and 16 large surface based water supply schemes including Tsunami Rehabilitation Scheme under the Jalanidhi project.

The Project commenced on 12.02.2001 with the idea to complete and close successfully by 31.12.2006. Since the model was experimented for the first time in India, certain inherent problems in the implementation process resulted to extend the duration upto September 2008. Jalanidhi Project was awarded Runners Up prize under the bank wise "Peoples First Award" competition held during the Feb 2008 Sustainable Development network Week held at the Bank's office in Washington DC.

### 2.5.3 KERALA WATER AUTHORITY

Kerala Water Authority was established on 1<sup>st</sup> April 1984 as an autonomous body of Government of Kerala by converting the erstwhile Public Health Engineering Department for the development and regulation of water supply and waste water collection and disposal in the State of Kerala.

#### ➤ Responsibilities

- Design, construction, execution, promotion, operation, maintenance and financing of schemes for the supply of water and for the collection and disposal of the waste water
- Rendering all necessary service to the Government relating to water supply and collection & disposal of waste water in the State of Kerala
- Establishment of standards for water supply and waste water service
- Fixation and revision of rates for water supply and sewerage maintenance with the approval of Government
- Taking other measures necessary to ensure water supply in time of emergency.
- Physical, chemical and bacteriological tests at specified intervals and check whether the water conforms to Water Quality Standards

### 2.5.4 KERALA STATE GROUND WATER DEPARTMENT

The Groundwater Department started as an independent department in the year 1978. Now it is the nodal department in the State for monitoring and management of groundwater.

- The department is having several wings like Hydrogeology, Engineering, Geophysical, Hydrology, Chemical, and Information Technology
- Resource evaluation, survey and investigation, drilling of wells, quality monitoring, development, technical assistance to Banks, etc forms the routine work of the department



- The water quality laboratory under Ground Water Department was established in late 70s
- Data for dissemination is generated using available softwares like Groundwater Estimation and Management Systems and Ground Water Data Entry System and is available on demand to different organizations on charges/fee prescribed by the Government

#### 2.5.5 CENTRAL GROUND WATER BOARD

A Unit Office of CGWB was started in 1978 at Trivandrum under the Southern Region, Hyderabad. A full fledged Regional Office of CGWB started functioning in Kerala in 1989 with the jurisdictional power of Kerala and U.T of Lakshadweep Island. Its activities are as follows

1. Exploration Drilling
2. Ground water Management Studies
3. Ground water level monitoring
4. Artificial Recharge Studies
5. Estimation of Ground water Resources
6. Short term water supply investigations
7. Photo geology & Remote Sensing
8. Surface Geophysical Surveys
9. Rajiv Gandhi Technology Mission Programme

#### 2.5.6 SUCHITWA MISSION

The Total Sanitation Campaign (TSC) in the State was coordinated and monitored by the Kerala Total Sanitation and Health Mission (KTSHM) and their activities were confined to the rural Panchayats. The Clean Kerala Mission (CKM) was enabling the urban and rural local bodies in establishing solid waste management systems. In order to avoid duplication of efforts and tackle the existing and emerging challenges in various sanitation aspects for an overall health and environmental outcome, it was felt necessary to have a professional institution. Accordingly, the above Missions were integrated as **Suchitwa Mission**, which started functioning since **April 2008**. This institutional reform has enabled the up scaling of initiatives envisaged in the Malinya Mukta Keralam Action Plan. The Mission is taking steps to strengthen its technical capabilities in various aspects of sanitation.

##### ➤ Main objectives

- Enable Local Self Government Institutions to implement the package of practices in sanitation
- Organize and monitor the implementation of Total Sanitation Campaign
- Provide technical support for sanitation programmes and projects
- Advise Local Self Government Institutions on environmental sanitation issues
- Evaluation of comprehensive waste management projects of Local Self Government Institutions and suggest corrective measures
- Extend complementary financial assistance to Local Self Government Institutions from the State budget provision
- Liaison between Local Self Government Institutions and other institutions /departments in the field of sanitation



- Organizing extensive Information, Education and Communication campaign on environmental sanitation
- Enable Local Self Government Institutions to achieve healthy environment and overall cleanliness

#### 2.5.7 CWRDM

Recognizing the need for catering to the R&D needs in the field of water management, the Centre for Water Resources Development and Management (CWRDM) was established as an autonomous research organization by the Government of Kerala, under its Science and Technology Policy in February 1978. The Centre initially had surface water, ground water, water management-agriculture, water quality and environment, education and extension as its mandate. After a decade, scientific divisions to deal with computer applications and isotope hydrology have been added. In order to cater to the requirements of main areas of research, certain central facilities like water analysis laboratory, cartography, reprography, manned observation stations, remote sensing cell and a museum have also been established. To take care of the special R&D needs of different hydro-ecologic regions of Kerala, five regional centers are also in operation since 1990.

- The Centre has substantially contributed to the scientific hydrologic studies and water management in the region
- The projects of CWRDM were funded by different departments and agencies of the Central and State Governments in addition to the international agencies like UNDP, UNEP, World Bank, USAID, NAS (US), JBIC, ICEF, etc.,
- The Centre tackled different problems pertaining to forest and urban hydrology, estuarine management, groundwater development, water quality management, water-related environmental issues, wetland management, watershed development, agriculture water management, irrigation and drainage issues, etc.,
- Several tools like mathematical modeling, systems approach, isotope hydrology and remote sensing techniques were made use of in the studies during the 1990s
- The hydrologic data generated by CWRDM are expected to be of immense use to the water managers of Kerala
- CWRDM has played a key role in supporting the Kerala Government in sorting out several water management issues
- The draft water policy of Kerala, adopted in 1992, was prepared by CWRDM. The government sought the advice of the Centre on several inter-State water issues
- The basic proposal leading to the Dutch-funded KCIP project and EC-funded KMIP project were drawn up by CWRDM
- A few of the water resources projects of the State were made environment-friendly by CWRDM
- The Centre initiated the JBIC-funded eco-restoration project of Attappady and ICEF-funded drinking water project in Lakshadweep, and carried out consultancy works for the Kerala Forestry Project and Kerala Rural Water Supply and Sanitation Project funded by the World Bank, and the Dutch-funded water supply project utilizing the water of Bharathapuzha

- The Centre was amalgamated with the Kerala State Council for Science, Technology and Environment in 2003

#### 2.5.8 DEPARTMENT OF LOCAL SELF GOVERNMENT

The Government decided to change the name of the Local Administration Department into the Department of Local Self-government. For administrative convenience, the Rural Development Department was merged with the department of Local Self-government and for the urban administrative matters special arrangement was made in the Secretariat. Consequent to the 74th Amendment to the Constitution of India, the Local self-government Institutions (LSGIs) are to function as the third tier of Government. In Kerala, LSGIs have been meaningfully empowered through massive transfer of resources as well as administrative powers. Coupled with a grassroots level approach of Participatory Planning whereby the developmental programmes are identified and implemented through Grama Sabhas, the LSGIs have emerged as effective agencies for the implementation of developmental programmes. There are 1214 local self-government bodies.

A series of participatory studies are also undertaken in every Gram Panchayat and Municipality, most important of which are the following

- a) **Collection of secondary data:** The relevant secondary data available in the various registers and records at the local level offices of different line departments were identified and collected in a common data format drawn up for the whole state
- b) **Study of local geography and natural resources:** A rapid appraisal of the natural resources was undertaken using walk technique. Eco-zones in every Panchayat were identified by first demarcating the area into various zones based on landform and then identifying the soil, water and vegetation characteristic to each zone. An environmental appraisal of each eco-zone was also attempted in many Panchayats
- c) **Review of ongoing schemes:** Each department is to prepare a sectoral report on the ongoing schemes and make them available to the Panchayats and Municipalities
- d) **Survey of local history:** A short local history is also prepared by every local body, mostly drawing from oral testimonies and local records. Participatory techniques such as history time line are also encouraged
- e) **Consolidation of Grama Sabha reports:** The reports of Grama Sabha discussions, including lists of problems identified, are then consolidated for each development sector in a Panchayat.

#### 2.5.9 KERALA STATE POLLUTION CONTROL BOARD

Kerala State Pollution Control Board is a regulatory authority for implementing various pollution control laws. The scarcity of land, high pollution density, high water table, high density of dug wells, and abundance of water body and high level of environmental awareness in the state makes KSPCB to adopt standards more stringent than those at national level.



- Development, evaluation and approval of pollution control technologies are statutory responsibility of KSPCB
- To assess the water quality of rivers, streams, wells and ambient air in the state and to plan the prevention, control and abatement of their pollution
- The Board has also undertaken various studies of underground water, soil and air to take remedial steps to control pollution
- The Board is monitoring water and air quality in the state at various locations through National and State level programme. 169 water monitoring stations and 24 air monitoring stations are covered in this manner
- It is proposed to do water quality monitoring stations at 16 more and air quality monitoring at 6 more stations in problematic areas.

### 3. BASELINE ENVIRONMENTAL STATUS

This chapter provides an overview of baseline data on relevant environmental components in the State. Based on a critical review and analysis of the baseline data, the issues of environmental concerns have been identified. This chapter also outlines the major issues arising from focused group discussions. The potential environmental issues, the risks associated with the proposed project activities during the design, preparatory, construction and operational phases of the project and their mitigation measures have been discussed.

#### 3.1 PHYSICAL ENVIRONMENT

##### 3.1.1 LOCATION

Kerala, with an area of 38,863 km<sup>2</sup> (1.18% of India's landmass) is wedged between the Arabian Sea to the west and the Western Ghats to the east. Kerala's coast runs some 580 km in length, while the State itself varies from 35-120 km in width. Kerala lies between north latitudes 8°18' and 12°48' and east longitudes 74°52' and 72°22' and is bounded by Tamil Nadu in the East and Karnataka in the North.

The State of Kerala is divided into 14 revenue districts. On the basis of geographical, historical and cultural similarities, the districts are generally grouped into Malabar Region (North Kerala) (Kasargod, Kannur, Wayanad, Kozhikode, and Malappuram), Kochi Region (Central Kerala) (Palakkad, Thrissur, and Ernakulam) and Travancore (South Kerala) (Thiruvananthapuram, Kollam, Alappuzha, Pathanamthitta, Kottayam, and Idukki). The 14 districts are further divided into 62 taluks, 999 revenue villages and 1007 Gram Panchayats. The location map of Kerala with its District boundaries is given in **Figure 3.1**. The salient features of the districts are presented in **Table 3.1**.

**Table 3-1 Districts of Kerala - Area, Population & Headquarters**

S.No.	Districts	Area	Population	District headquarters
1	Thiruvananthapuram	2,192	2,938,583	Thiruvananthapuram
2	Kollam	2,579	2,398,285	Kollam
3	Alappuzha	1,256	1,990,603	Alappuzha
4	Pathanamthitta	2,731	1,186,628	Pathanamthitta
5	Kottayam	2,204	1,819,581	Kottayam
6	Idukki	4,998	1,076,555	Painav
7	Ernakulam	2,408	2,797,779	Kochi
8	Thrissur	3,032	2,734,333	Thrissur
9	Palakkad	4,480	2,376,160	Palakkad
10	Malappuram	3,548	3,093,190	Malappuram
11	Kozhikode	2,345	2,612,897	Kozhikode
12	Wayanad	2,132	671,195	Kalpetta
13	Kannur	2,997	2,224,819	Kannur
14	Kasargod	1,961	1,070,629	Kasargod

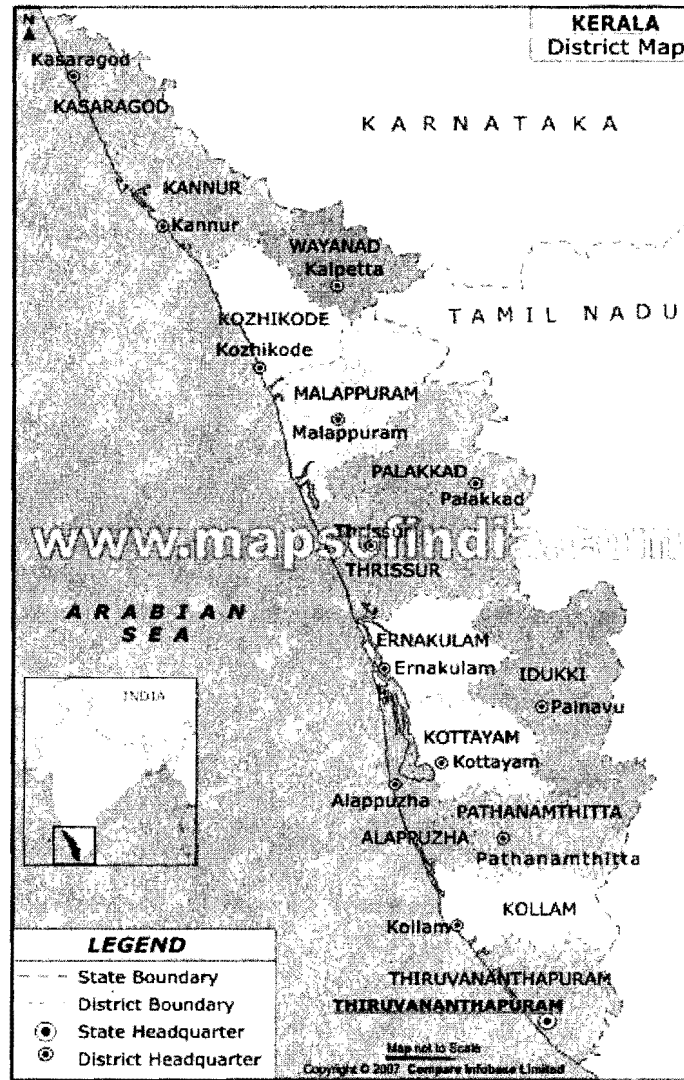

Figure 3-1 Location Map of Kerala with its District Boundaries

### 3.1.2 PHYSIOGRAPHY

Kerala is divided into three geographical regions, namely

- Highlands
- Midlands
- Lowlands

**The Highlands** slope down from the Western Ghats (also known as the Sahyadri) which rise to an average height of 900m, with a number of peaks well over 1800 m in height. It is 1860 sq.km in area and accounts for 48 percent of the total land area of Kerala. This is the area of major plantations like tea, coffee, rubber and various spices. This area is often known as the Cardamom Hills. This region is one of the largest producers of many spices especially cardamom from which it earns its name. Anaimudi (2694 meters) is the highest point in South India, and also the highest point in India outside the Himalaya-Karakoram mountain range. Most of the rivers of Kerala originate from the Western Ghats.



**The Midlands**, lying between the mountains and the lowlands, is made up of undulating hills and valleys. It is 16200 sq.km in area i.e., about 40 percent of the total land area. This is an area of intensive cultivation. Cashew, coconut, arecanut, tapioca, banana and vegetables of different varieties are grown in this area.

**The Lowlands** are also known as the Coastal Area. It covers an area of almost 4000 sq.km. It is made up of numerous shallow lagoons known locally as *kayels*, river deltas, backwaters and shores of the Arabian Sea and is essentially a land of coconuts and rice. This area is very fertile and most of the paddy cultivation is along this area. *Kuttanad* region of Kerala is one of the very few places in India where cultivation is done below sea level. Water is the main mode of transportation in these areas. The Physiographic of Kerala is given in **Figure 3.2**.

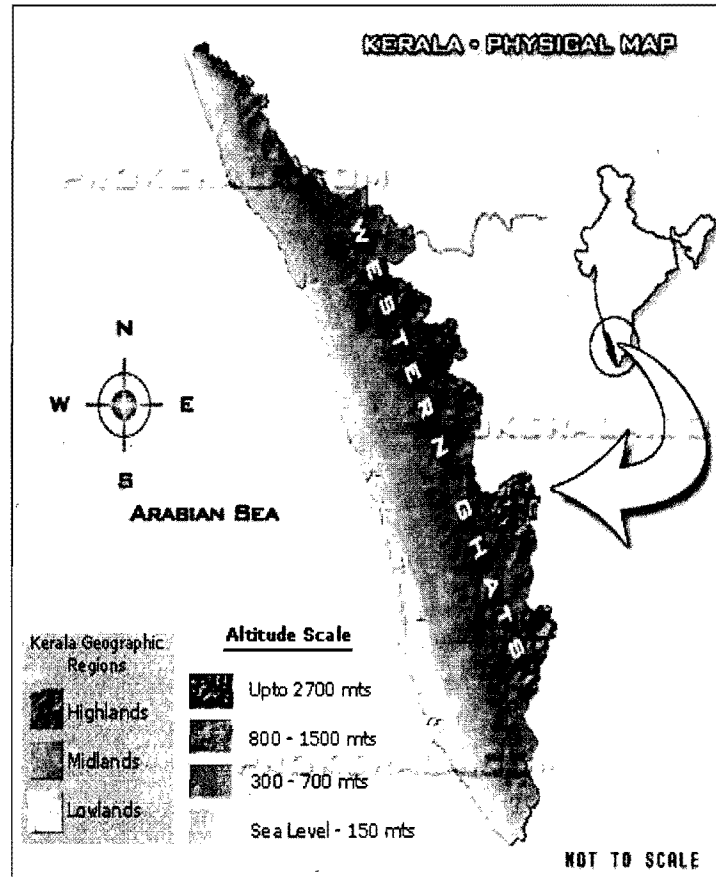

Figure 3-2 Physiography of Kerala

### 3.1.3 RIVERS OF KERALA

Kerala is a land abundant in water resources, which include rivers, lakes, backwaters, big and small ponds etc. Lion's share of the States water needs is supplied by the rivers. Kerala has 44 rivers of which 41 are west flowing and 3 east flowing. The west flowing rivers flow down the land and join the Arabian Sea or the backwater lakes which open into the sea.



Many of these rivers serve as inland waterways in many part of the State. Water from these rivers is used for irrigational purposes, drinking, hydro electric power production etc... They also serve as grounds for inland fishing.

Unlike the rivers of north India, which arise from the Himalayas and are both rain-fed and snow-fed, rivers of the south cannot be treated as a perennial source of water supply. This is because all these rivers are comparatively small and are entirely rain-fed with the result that many of them shrink into rivulets or dry up completely during hot seasons.

### **3.1.3.1 Lakes and Backwaters of Kerala**

Backwaters' or 'Lagoons' are shallow bodies of water separated from the open sea by land. Because of this separation from the sea, Backwaters are free from the pounding action of waves. Backwaters are one of the most alluring and economically valuable features of Kerala. These include lakes and ocean inlets, which stretch irregularly along the coast.

The biggest backwater is the Vembanad Lake with an area of 260sq.km. Secondly, the Ashtamudi, which covers an area of 55 sq.km. Sastamkotta Lake is the largest natural fresh water lake of the state. It extends over an area of 4sq.km. Other important backwaters are Veli, Kadhnamkulam, Anjuthengu (Anjengo), Edava, Nadayara, Paravoor, Kayamkulam, Kodungallur (Cranganore) and Chetuva. The deltas of the rivers interlink the backwaters providing excellent inland waterways along the lower and costal areas of the state.

Backwaters serve as hot spots of Kerala tourism. The picturesque lagoons and backwaters of the state, attracts a considerable number of tourists each year. Backwater tourism includes cruises on luxury houseboats, boating, boat races etc... Nehru Trophy boat race, one of Kerala's most famous boat races is held each year on the Punnamada backwaters of Alappuzha district. **The map showing the Rivers of Kerala is given in Figure 3.3**

\* The length of the rivers is approximate measures and is likely to vary with time and season.

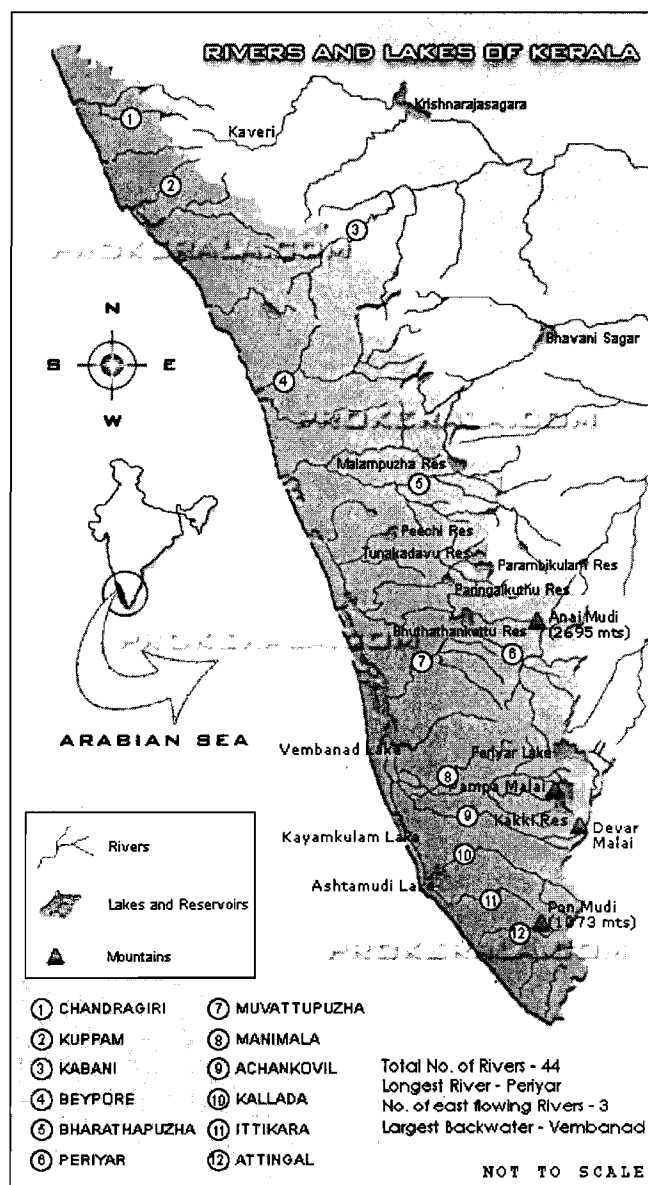

Figure 3-3 Rivers of Kerala

**3.1.4 SOIL PROFILE OF KERALA**

Kerala possess a wide range of soil types. These varied kinds of soils and the varying climatic conditions ranging from tropical, equable, hot, humid and dry enables the growth of an assortment of flora and other plantation crops. There is a variety of different soils including red, ferruginous, sandy, black, peat lateric and loamy soil in many parts of the State. The soil of South Western peninsula of India- Kerala is lateritic and very permeable like the soil of desert or arid regions. The soil is devoid of any humus and is unable to retain much water. However Alluvium soil is usually found along the banks of the main rivers and broadly in the lower basins of the Pampa and Periyar rivers. Besides these regions, alluvial deposits are also found in the paddy fields of Kerala. Sandy soil and loamy soils are found in the Coastal regions. Laterite soil is

found in the midland regions and highlands, Red soil in the Southern-most part of Kerala, Black soil in the Chittur Village of Palakkad district, Peat soil in Kuttanad district and Acidic Saline soil are found in the Kaipad areas. The district soil profile is given in **Table 3.2.**

**Table 3-2 District Soil Profile**

<b>District</b>	<b>Type of Soil</b>	<b>Details of location</b>
Thiruvananthapuram	<ul style="list-style-type: none"> <li>Fairly rich brown loam of laterite</li> <li>Sandy loam</li> <li>Rich dark brown loam of granite origin</li> </ul>	Middle part of the district  Western coastal region Eastern hilly parts of the district
Kollam	<ul style="list-style-type: none"> <li>Sandy loam</li> <li>Laterite soil</li> </ul>	Karunagappally and part of Kollam taluks Kottarakkara , Kunnathur and parts of Kollam and Pathanapuram taluks
Pathanamthitta	<ul style="list-style-type: none"> <li>Clay soil</li> <li>Laterite soil</li> </ul>	Western and Eastern hilly regions Parts of Ranni and Kozhencheri taluks
Alappuzha	<ul style="list-style-type: none"> <li>Sandy loam</li> <li>Sandy soil</li> <li>Clay loam with much acidity</li> <li>Laterite soil</li> </ul>	Karthikappally and parts of Mavelikkara taluks Cherthala & Ambalappuzha taluks Kuttanad  Chengannur and parts of Mavelikkara taluks
Kottayam	<ul style="list-style-type: none"> <li>Laterite soil</li> <li>Alluvial soil</li> </ul>	Parts of Changanacherry and Kottayam taluks and Kanjirappally and Meenachil taluks. Vaikom taluk and part of Changanacherry and Kottayam taluks
Idukki	<ul style="list-style-type: none"> <li>Laterite soil</li> <li>Alluvial soil</li> </ul>	Peermade and Thodupuzha taluks Devicolam and Udumbanchola taluks
Ernakulam	<ul style="list-style-type: none"> <li>Laterite soil</li> <li>Sandy loam</li> <li>Alluvial soil</li> </ul>	Muvattupuzha, Kothamangalam and part of Aluva and Kunnathunad taluks Parur, Kochi and Kanayannur taluks Parts of Aluva and Kunnathunad taluks
Thrissur	<ul style="list-style-type: none"> <li>Sandy loam</li> <li>Laterite soil</li> </ul>	Part of Mukundapuram, Thrissur and Chavakkad taluks Eastern part of Thrissur and

District	Type of Soil	Details of location
	<ul style="list-style-type: none"> <li>• Clayey soil</li> <li>• Alluvial soil</li> </ul>	Western part of Thalappally taluks Back-water area of Chavakkad and Mukundapuram taluks Portions of Chavakkad taluk
Palakkad	<ul style="list-style-type: none"> <li>• Laterite soil</li> <li>• Black soil</li> </ul>	Major part of the district North-Eastern part of Chittur taluk
Malappuram	<ul style="list-style-type: none"> <li>• Laterite soil</li> <li>• Sandy soil</li> </ul>	Interior region of the district Along the costal belt of the district
Kozhikode	<ul style="list-style-type: none"> <li>• Laterite soil</li> <li>• Sandy soil</li> </ul>	Major part of the district except coastal strip Coastal strip
Wayanad	<ul style="list-style-type: none"> <li>• Laterite soil</li> <li>• Loamy soil</li> </ul>	Major part of the district Valleys in the middle portion of the district
Kannur	<ul style="list-style-type: none"> <li>• Laterite soil</li> <li>• Sandy soil</li> </ul>	Major part of the district except coastal strip Coastal strip
Kasargod	<ul style="list-style-type: none"> <li>• Laterite soil</li> <li>• Sandy soil</li> </ul>	Major part of the district except coastal strip Coastal strip

### 3.1.5 CLIMATE AND RAINFALL

Compared to other Indian States, Kerala lies closer to the equator. Yet Kerala is bestowed with a pleasant and equable climate through out the year. This is because of the land's nearness to the sea and the presence of the fort like Western Ghats on the east. Kerala enjoys a balmy weather almost all through the year. It is neither too cold in the winter months nor too hot in summer. The warmer (>32°C) months are March-May and September-October. Mid-May to August is the monsoon period, and one can expect a wet time. In addition, June is also a windy month.

The average annual rainfall of the State is estimated at 3000 mm. However, the spatial and temporal distribution pattern is mainly responsible for the frequent floods and droughts in Kerala. The average annual rainfall in the lowland of Kerala ranges from 900mm in the south to 3500 mm in the north. In the midland, annual rainfall ranges from 1400mm in the south to 4000 mm in the north. In the highlands, annual rainfall varies from 2500 mm in the south to about 6000 mm in the north. About 60% of the annual rainfall in the state is received during the South-West monsoon (June-August), 25% during North-East monsoon (September - November) and the remaining during the summer months.

There are certain areas in the Attappady valley with only 600 mm annual average rainfall. Generally, the high ranges receive more rainfall than the other zones, mainly due to a phenomenon called orography-hills influencing rainfall. Areas on the eastern side of the Western Ghats have less rainfall and are rightly called 'rain-shadow' areas; the rainfall in regions close to the gaps, such as Palakkad is also comparatively less due to the escape of moisture-laden clouds through the gaps. While the temporal

distribution of rainfall depends on the monsoon winds to a great extent, the spatial distribution depends on the configuration of land, especially the undulating topography of the ghats.

Rainfall is the major source of ground water recharge and the rainfall pattern plays an important role on the water levels in the phreatic aquifers and to the deeper aquifers.

### 3.2 WATER RESOURCES ENVIRONMENT

#### 3.2.1 SURFACE WATER RESOURCES

The rivers of Kerala are monsoon fed and fast flowing. According to earlier estimates (PWD, 1974), the total runoff of the rivers of the State amounts to about 77,900 Mm<sup>3</sup>, of which 70,200 Mm<sup>3</sup>, is from Kerala catchments and the remaining 7700 Mm<sup>3</sup>, is from Karnataka and Tamil Nadu catchments. **Table 3.3** gives the water potential of the river basins of the State.

Kerala has 44 rivers, a river in Kerala is defined as a drainage channel, which is more than 15 Km in length. As per national norm, rivers with drainage areas of more than 20000 and 2000 sq.kms are called major and medium rivers respectively. Rivers with less than 2000 sq km are termed as minor rivers (Rao, 1979). With this national norm, Kerala does not have a single major river and has only 4 medium rivers (Chaliyar, Bharathapuzha, Periyar, Pamba), with a total drainage area of 8250 sq km. The remaining 40 rivers are only minor rivers with a total catchment area of 19,489sq.km. The total catchment area of all the 44 rivers together is only 28739 sq km. The total discharge of these rivers is 77900 Mm<sup>3</sup>.

Table 3-3 Water potential of the river basins of Kerala

Name of Basin	Annual Yield Mm <sup>3</sup>			Annual Utilizable yield Mm <sup>3</sup>		
	Total	In Kerala	Outside	Total	In Kerala	Outside
Manjeswar - Uppala	698	309	389	379	106	273
Shiriya	1337	620	717	973	358	615
Chandragiri - Mogral	3964	1718	2246	3129	1218	1911
Nileshwar - Karingode	1710	1356	354	1238	937	301
Kavvayi- Peruvamba- Ramapuram	1143	1143	Nil	603	603	Nil
Kuppam	1516	1236	280	1024	786	238
Valapattanam	4092	2784	1308	2938	1823	1115
Anjarakandy	986	986	Nil	503	503	Nil
Tellicherry	251	251	Nil	122	122	Nil
Mahe	803	803	Nil	445	445	Nil
Kuttiyadi	1626	1626	Nil	1015	1015	Nil
Chaliyar- Korappuzha - Kallayi-Kadalundi	7775	7135	640	3160	2616	544
Tirur	165	165	Nil	60	60	Nil
Bharathapuzha	7478	6540	938	4146	3394	797
Keecheri- Puzhakkal	1024	1024	Nil	345	345	Nil
Karuvannur	1887	1887	Nil	963	963	Nil
Chalakkudy	3121	2541	580	2033	1539	494



Name of Basin	Annual Yield Mm <sup>3</sup>			Annual Utilizable yield Mm <sup>3</sup>		
	Total	In Kerala	Outside	Total	In Kerala	Outside
Periyar	11607	11341	266	8232	8004	228
Muvattupuzha	3814	3814	Nil	1812	1812	Nil
Meenachil	2349	2349	Nil	1110	1110	Nil
Manimala	1829	1829	Nil	1108	1108	Nil
Pamba	4641	4641	Nil	3164	3164	Nil
Achencovil	2383	2383	Nil	1249	1249	Nil
Kallada- Pallickal	2270	2270	Nil	1368	1368	Nil
Ithikkara	761	761	Nil	429	429	Nil
Vamanapuram- Ayroor Mamom	1324	1324	Nil	889	889	Nil
Karamana	836	836	Nil	462	462	Nil
Neyyar	433	433	Nil	229	229	Nil
Kabbini*	4333	4333	Nil	4333	4333	Nil
Bhavani*	1019	1019	Nil	1019	1019	Nil
Pambar*	708	708	Nil	708	708	Nil
<b>Total</b>	<b>77883</b>	<b>70165</b>	<b>7718</b>	<b>49188</b>	<b>42672</b>	<b>6516</b>

\*East flowing

Source: Water Resources of Kerala, PWD, 1974

Kerala has 44 rivers, a river in Kerala is defined as a drainage channel, which is more than 15 Km in length. As per national norm, rivers with drainage areas of more than 20000 and 2000 sq.kms are called major and medium rivers respectively. Rivers with less than 2000 sq km are termed as minor rivers (Rao, 1979). With this national norm, Kerala does not have a single major river and has only 4 medium rivers (Chaliyar, Bharathapuzha, Periyar, Pamba), with a total drainage area of 8250 sq km. The remaining 40 rivers are only minor rivers with a total catchment area of 19,489sq.km. The total catchment area of all the 44 rivers together is only 28739 sq km. The total discharge of these rivers is 77900 Mm<sup>3</sup>.

#### 3.2.1.1. Surface Water Quality

The short, fast-flowing, monsoon-fed rivers of Kerala often encounter salinity intrusion into their lower stretches during the summer months. When the fresh water flow reduces, two major problems can occur in these water bodies: (i) salinity propagates more into the interior of the river and (ii) the flushing of the system becomes less effective. The pollution of the rivers is more severe in downstream. Majority of the Rivers in Kerala has Biochemical Oxygen Demand within 10 mg/l. Bacteriological contamination is one of the major water quality problems of the Kerala Rivers. Water quality of the rivers is presented in **Table 3.4**.

#### Implication for EMF

- Water quality of the rivers should be carried out periodically (once in 3 months)
- Construction of weirs/barrage/bunds across the rivers to prevent salt water ingress.
- Safe sanitation technologies to be implemented to prevent the bacteriological contamination of rivers.



Table 3-4 Water Quality of Rivers

S.No	Stations Unit	pH	EC µmhos/cm	DO mg/l	BOD mg/l	Nitrate mg/l	Amm -N mg/l	TC No/100ml	FC No /100ml
1	Neyyar River Amaravila (Neyyatinkara Village)	6.65	73.25	7.225	0.9	0.2825	0.395	2150	6
2	Aruvippuram (Perumkadavila Village)	6.5	71.5	6.58	0.73	0.30	0.28	1655	462
3	Mamom River Mamom Bridge (Attingal Village)	6.73	122.00	6.38	0.68	0.33	0.32	1630	342
4	Ayroor River Ayroor Bridge (Ayroor Village)	6.575	107.25	5.4	0.85	0.2625	0.385	1912	242
5	Karamana River Moonnattumukku (Thiruvallom Village)	6.62	4218.33	0.73	12.48	1.48	5.59	12449	12089
6	Ithikkara River (Ithikkara Bridge)	7.00	5655.50	6.23	0.85	1.05	0.03	268	144
7	Ayroor Bridge	7.00	82.75	5.23	0.55	0.93	0.05	505	282
8	Vamanapuram River (Vamanapuram Village)	6.63	64.00	7.60	0.73	0.29	0.23	1425	288
9	Pallickal River Nellimughal	7.08	70.75	6.88	0.50	0.51	0.03	246	124
10	Achenkovil River Thumpamon	6.96	61.58	6.80	0.54	0.93	0.03	434	240
11	Chennithala	7.00	78.50	6.38	0.83	0.73	0.40	492	272
12	Kallada River erumthottamkadavu	6.98	49.08	7.29	0.67	0.66	0.12	446	228
13	Pamba River Pamba Down (Mannar Panchayat)	6.70	54.50	6.13	1.35	0.55	0.05	1450	825
14	Chenganoor (Chenganoor Municipality)	6.45	40.25	6.88	0.95	0.42	0.28	1082	540
15	Thakazhy (Thakazhy Panchayat)	6.63	230.50	6.40	0.95	0.23	0.75	1087	655
16	Meenachil River Kidangoor (Kidangoor Panchayat)	6.68	48.50	7.18	0.78	0.44	0.00	1400	1000
17	Manimala River Thondara (Kuttoor Panchayat)	7.08	66.25	6.80	1.13	0.67	0.00	712	466

S.No	Stations Unit	pH	EC µmhos/cm	DO mg/l	BOD mg/l	Nitrate mg/l	Amm -N mg/l	TC No/100ml	FC No /100ml
18	Kallooppara (Kallooppara Panchayat)	7.08	61.00	6.83	1.48	0.50	0.00	485	130
19	Periyar River Eloor (Kadungallore Panchayat)	6.61	1427.33	5.48	1.60	0.69	0.07	1208	284
20	Kalady (Kalady Panchyat)	6.79	41.33	6.35	0.75	0.21	0.02	1503	260
21	Aluva (Aluva Municipality)	6.61	49.25	6.48	1.03	0.24	0.02	598	152
22	Pathalam (Kadungallore zanchayat)	6.51	861.17	5.78	1.47	0.36	0.15	873	196
23	Kalamasserry (Kalamasserry Municipality)	6.57	647.75	4.66	1.82	0.33	0.06	1052	2.14
24	Purpallikadavu (Chengamanadu Panchayat)	6.63	1201.42	6.58	1.18	0.24	0.02	664	176
25	Muppthadam (Kadungallore Panchayat)	6.70	70.00	5.75	1.70	0.50	0.11	427	74
26	Kadambrayar Brahmapuram (Thrikkakkara Panchayat)	6.30	125.46	1.34	2.18	0.43	0.12	954	344
27	Manakkakadavu (Thrikkakkara Panchayat)	6.24	71.27	1.49	1.47	0.09	0.01	1204	302
28	Moovattupuzha Vettikkattumukku (Mevallore Panchayat)	6.68	66.50	6.69	1.28	0.39	0.05	1025	310
29	Chalakydypuzha Pullickakadavu (Kadukutty Panchayat)	6.32	103.05	12.43	1.68	0.39	0.14	645	125
30	Chithrapuzha Irumpanam (Trippunithura Municipality)	6.30	125.46	1.34	2.18	0.43	0.12	954	344
31	Karuvanoor River Karuvanoor Bridge (Porathissery Village)	6.45	55.00	6.73	0.93	0.60	0.12	500	266
32	Puzhakal River Puzhakkall Bridge (Adat Panchayat)	6.85	76.75	5.95	1.80	0.61	0.10	500	240
33	Keecheri River Vadakkancherry (Eranelur village)	6.85	76.75	5.98	1.80	0.61	0.10	500	240



S.No	Stations Unit	pH	EC µmhos/cm	DO mg/l	BOD mg/l	Nitrate mg/l	Amm -N mg/l	TC No/100ml	FC No /100ml
34	Korayar Kanjikkode (Kanjikkode Panchayat)	7.58	6232.25	6.08	0.45	0.25	0.07	1540	677
35	Bharathapuzha River Kuttipuram (Kuttipuram Panchayat)	7.53	118.75	6.78	0.40	0.18	0.08	918	478
36	Pattambi (Pattambi Panchayat)	7.63	161.25	7.05	0.40	0.19	0.10	1675	710
37	Kadalundi River Tiruramgadi (Tiruramgadi Village)	6.43	79.50	6.58	0.91	0.09	0.00	636	186
38	Hajiyarpally (Panakad Village)	36.4	78.00	7.35	1.14	0.10	0.00	720	280
39	Tirur River Thalakadathur (Cheriyamundam Village)	6.125	4967.75	5.15	1	0.1125	0.0025	820	236
40	Chaliyar River Koolimadu (Chathamangalam Panchayat)	6.88	55.08	6.90	0.53	0.23	0.00	704	394
41	Chungapally (Perumana Panchayat)	6.96	7716.00	6.73	0.58	0.26	0.01	665	443
42	Kabani River Muthankara (Mananthavadi Panchayat)	6.83	79.75	6.80	0.50	0.47	0.05	735	425
43	Bhavani River Elaichivazhi (Agali Panchayat)	7.20	106.50	7.38	0.55	0.11	0.06	885	440
44	Kuttiyadipuzha Estatemukku (Chakkittappara Panchayat)	6.725	26.75	6.9	0.275	0.1975	0.035	180	40
45	Mahe River Valayam (Valayam Panchayat)	6.475	183.75	6.225	0.475	0.2055	0.05	400	232
46	Kallaipuzha Kallai Bridge (Kozhikode Corporation)	7.25	20429.75	3.48	1.28	0.62	6.07	1190	560
47	Korapuzha Kanayankode	7.05	13256.75	6.03	1.10	0.14	0.11	1465	750
48	Kuppam River Taliparamba (Taliparamba Village)	6.45	15737.50	6.15	1.00	0.93	0.00	360	232
49	Rayoram (Alakkode Village)	6.40	58.50	7.13	0.90	0.13	0.00	275	178

S.No	Stations Unit	pH	EC µmhos/cm	DO mg/l	BOD mg/l	Nitrate mg/l	Amm -N mg/l	TC No/100ml	FC No /100ml
50	Thalassery River Pathipalam (Patyam)	6.40	58.50	7.13	0.90	0.13	0.00	275.00	178
51	Ancharakkandy River Ancharakandi (Ancharakandy Village)	6.15	4165.25	4.85	413.3 3	0.17	0.00	302	168
52	Meruvamba (Vengad Village)	6.10	58.50	6.60	1.03	0.15	0.00	385.00	248
53	Ramanapuram River Ramapuram Bridge (Cheruthazham Village)	6.30	7034.50	6.40	0.78	0.18	0.00	195.00	110.00
54	Kavai River Kuttiolpalam (Peralam Village)	5.98	79.50	6.78	0.75	0.19	0.04	100	52
55	Neeleswaram River Hosdurg (Neeleswaram Village)	7.13	18458.75	4.95	1.03	0.08	0.03	917	517
56	Nambiarckan (Hosdurg Village)	6.70	3130.75	6.40	2.23	0.12	280.00	555	820
57	Karingode River Kakkadavu (Cheemeni Village)	7.03	44.75	7.43	1.13	0.11	0.05	1932	1042
58	Chandragiri Puzha Padiayathadka	6.70	52.25	7.60	2.60	0.12	0.05	962	612
59	Pullur River Pullur Bridge (Ajanoor Village)	6.65	58.00	6.63	1.48	0.15	0.05	1900	1412
60	Mogral River Mogral Bridge (Mogral Village)	6.73	19885.25	5.23	1.15	0.18	0.06	2275	842
61	Shriya River Angadimograu (Angadimograu Village)	6.50	77.00	7.70	1.30	0.10	0.50	2535	2010
62	Uppala River Uppala Bridge (Uppala Village)	7.23	19085.25	5.65	1.35	0.08	0.03	2785	1795
63	Manjeswaram River Bajrakkara Bridge (Vorcardi Village)	6.25	129.50	6.30	1.65	0.10	0.06	3860	2125
64	Pervamba River Chandapura (Kandanapally Village)	5.98	51.25	7.33	0.90	0.21	0.04	340	195

Source: Water & Air Quality Directory, 2009

### 3.2.2 GROUND WATER RESOURCES

Geologically 88% of the State is underlain by crystalline rocks of Archaean age, which is a part of the peninsular shield. The crystalline complex of Kerala is composed of charnockites, gneisses, schists, migmatites and rocks of the Wayanad supracrystals. Along the western portion of the State, the crystalline rocks are overlain by the sedimentary formations of Tertiary age and recent alluvial formations. The Tertiary sequence of formations have been divided into four beds viz. Alleppey, Vaikom, Quilon and Warkali, the age of which ranges from Eocene to Lower Miocene. Laterites of Sub-recent age derived from the crystalline as well as sedimentary formations are seen all along the midlands. Along the coastal plains, sedimentaries and laterites are overlain by alluvium of recent age. (Source: Groundwater Year book of Kerala 2008-2009)

#### 3.2.2.1 Occurrence of Ground Water

Ground water occurs under phreatic, semi-confined and confined conditions in the above formations. The weathered crystallines, laterites and alluvial formations form the major phreatic aquifers, whereas the deep fractures in the crystallines and the granular zones in the Tertiary sedimentary formations form the semi-confined and confined aquifers.

Thick zones of weathered crystallines are seen along midland region. The depth to water level in the weathered crystallines in the midland area ranges from 3 to 16 mbgl. The midland area sustains medium capacity dug wells for irrigation. Along the hill ranges, the crystalline rocks are covered by thin weathered zone. Mostly dug wells that can cater to domestic needs are feasible along topographic lows. Bore wells tapping deeper fractured aquifer are feasible along potential fractures in the midland and hill ranges. Potential fractures are seen down to 240 mbgl and the most productive zone lies between 60 and 175 mbgl and the discharge of bore wells range between 36,000 and 1,25,000 lph.

Of the four Tertiary beds, the two beds viz. the Vaikom and Warkali form potential aquifers. The oldest Alleppey beds contain brackish water as inferred from electrical logs, whereas the Quilon beds are poor aquifers. The Vaikom aquifer is seen all along the coast between Quilon and Ponnani and the piezometric surface ranges from 1 to 18 m above msl. The aquifer is extensively developed between Quilon and Kayankulam. The aquifer contains fresh water south of Karuvatta in Alleppey district and in isolated pockets in Ernakulam district. The annual flow in the aquifer is computed as 43 MCM, of which 10 MCM is brackish. The Warkali aquifer is seen south of Cochin. The piezometric head in the aquifer varies from 2.6 m above msl to 10 m below msl. The aquifer is largely developed in and around Alleppey. The annual flow in the aquifers is computed as 63 MCM and the draft is around 22 MCM.

Laterites are the most widely distributed lithological unit in the State and the thickness of the formation varies from a few meters to about 30m. The depth to water level in the formation ranges from less than a meter to 25 mbgl. Laterite forms potential aquifers along valleys and can sustain medium duty irrigation wells with the yields in the range of 0.5 - 6 m<sup>3</sup> per day.

The alluvium forms potential aquifer along the coastal plains and ground water occurs under phreatic and semi-confined conditions in this aquifer. The thickness of this

formation varies from few meters to above 100 m. and the depth to water level ranges from less than a meter to 6 mbgl. Filter point wells are feasible wherever the saturated thickness exceeds 5 m.

#### **3.2.2.2 Ground Water Availability**

Reliable estimates of the total ground water potential and its distribution over different regions of the state are basic information needed for formulating any plans for groundwater storage being replenished every year by the recharge to the aquifer system from the rainwater. Central Ground Water Board, State Ground Water Department, Central Water Commission and Centre for Water Resources Development and Management have estimated the ground water potential of the state.

District wise Net Ground Water Availability as on March 2004 is given in **Table 3.5**. The net groundwater availability in the entire Kerala State is 6229.55 million cubic meter (MCM).

Table 3-5 District Wise Net Groundwater Availability of Kerala State (In MCM)

S. No	Assessment Unit/District	Command area/ Non command area	Recharge from rainfall during monsoon season	Recharge from other sources during monsoon season	Recharge from rainfall during non monsoon season	Recharge from other sources during non-monsoon season	Total Annual Ground water Recharge	Natural discharge during non monsoon season	Net Annual Ground water Availability
1	Thiruvananthapuram	N.C	128.18	Nil	150.11	30.22	308.51	30.48	278.03
2	Kollam	N.C	235.84	Nil	218.22	41.55	495.61	47.36	448.25
3	Alappuzha	N.C	221.00	Nil	136.39	108.69	466.08	46.62	419.46
4	Pathanamthitta	N.C	151.41	14.86	145.89	34.83	346.99	30.44	316.55
5	Kottayam	N.C	281.72	Nil	171.38	67.96	521.06	50.23	470.83
6	Idukki	N.C	172.27	Nil	72.79	23.98	269.04	22.72	246.32
7	Ernakulam	N.C	308.12	Nil	171.15	139.14	618.42	50.59	567.83
8	Thrissur	N.C	418.46	Nil	191.22	165.25	774.93	72.18	702.75
9	Palakkad	N.C	358.09	Nil	157.56	308.24	823.88	73.55	750.33
10	Malappuram	N.C	320.10	Nil	156.06	81.14	557.30	49.66	507.64
11	Wayanad	N.C	237.49	Nil	66.55	20.99	325.03	32.44	292.59
12	Kozhikode	N.C	270.38	Nil	96.03	Nil	366.41	21.60	344.81
13	Kannur	N.C	408.63	Nil	116.2	67.06	591.89	51.27	540.62
14	Kasargod	N.C	277.18	Nil	78.52	20.48	376.18	32.64	343.5477
<b>Total</b>			<b>3788.88</b>	<b>14.86</b>	<b>1928.08</b>	<b>1109.53</b>	<b>6841.33</b>	<b>611.75</b>	<b>6229.55</b>

N.C- Non Command Source: Dynamic Ground Water Resources of Kerala, Ground Water Department & Central Ground Water Board, 2008

### 3.2.2.3 Long Term Ground Water Level Trend

The depth to water level mostly depends on the Hydro geological conditions of the area as well as topography, rainfall pattern, etc. In coastal plains the depth to water level is generally restricted to 6 mbgl. In midland areas, where the undulating topography is seen, the depth to water level generally varies from near ground level to 25 mbgl. The variation is mostly due to topographical variations, thickness of lateritic overburden etc. In areas where laterites are underlain by sedimentary aquifers of Tertiary age, the water level goes very deep, even to the extent of 55 mbgl. In highlands the depth to water level is in the range of few cm to 10 mbgl depending on the topography and thickness of overburden (weathered zone).

The long-term water level data was analyzed for the period of 1999-2008. The map showing pre-monsoon water level trend for the period 1999-2008 is shown in **Figure 3.4.** (Ground Water Year book of Kerala-2009).

The analysis of **pre-monsoon water level trend** for the **last decadal period** (i.e. during 1999 – 2008) indicates that

- Only 39.28% of GWMWs have recorded negligible change in water level in the range of +0.05 to -0.05 m/year.
- 5.36% of monitoring wells have recorded declining trend in the range of 0.05 to 0.1 m/year and 10.45% of monitoring wells have recorded declining trend above 0.1 m/year.
- 19.32% of monitoring wells have recorded rising trend in the range of 0.05 to 0.1 m/year and 25.74% of monitoring wells have recorded rising trend above 0.1 m/year.
- The long term ground water level trend for the pre-monsoon period shows that a rise in water level is more predominant.

The map showing post-monsoon water level trend for the period 1998-2007 is shown in **Figure 3.5.** The analysis of post-monsoon water level trend for the last decadal period (i.e. during 1999 – 2008) indicates that

- Only 39.59% of GWMWs have recorded negligible change in water level in the range of +0.05 to -0.05 m/year.
- 15.27% of monitoring wells have recorded declining trend in the range of 0.05 to 0.1 m/year and 25.51% of monitoring wells have recorded declining trend above 0.1 m/year.
- 7.43% of monitoring wells have recorded rising trend in the range of 0.05 to 0.1 m/year and 12.16% of monitoring wells have recorded rising trend above 0.1 m/year.

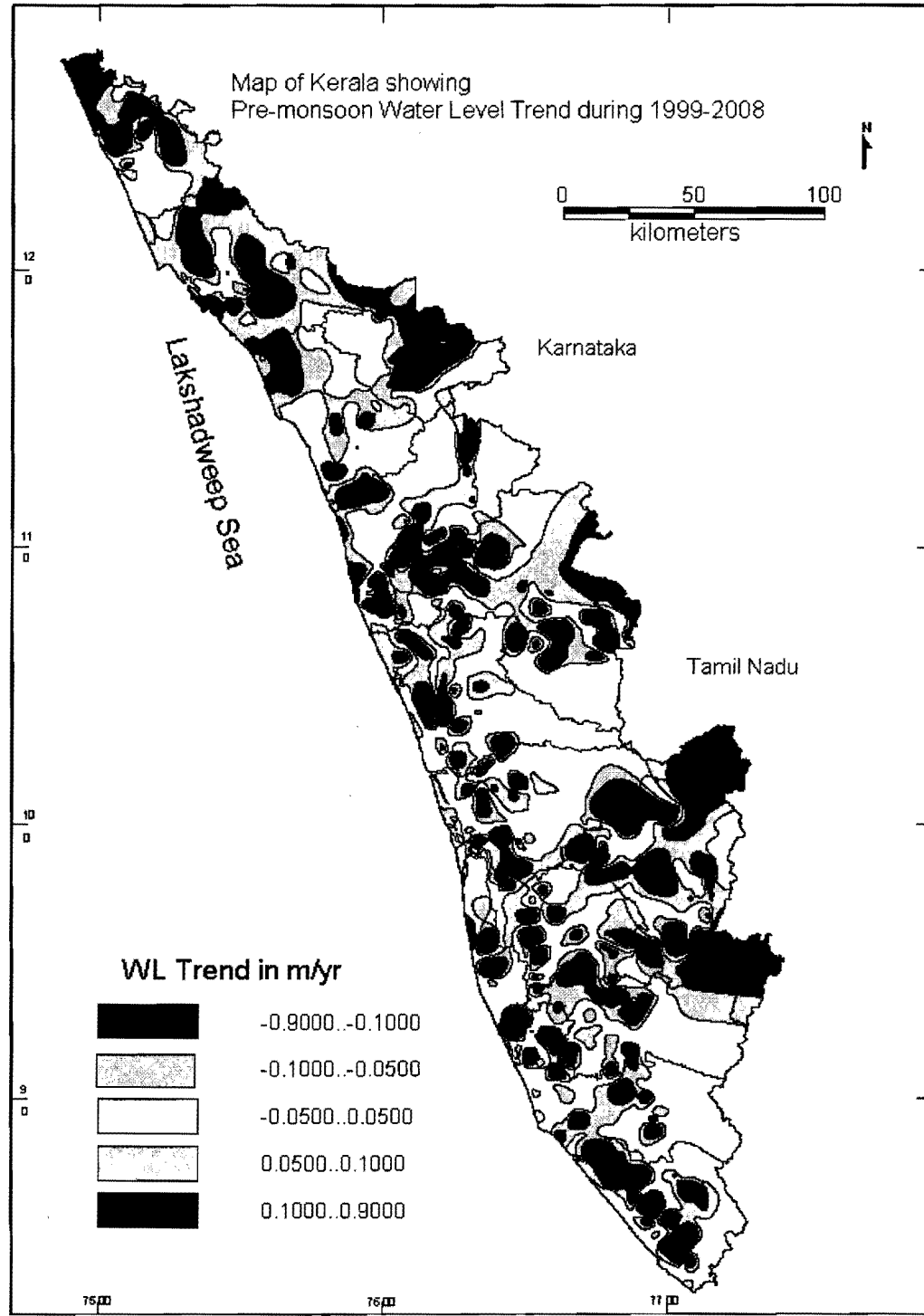

Figure 3-4 Pre-Monsoon Water Level Trend for the Period 1999-2008

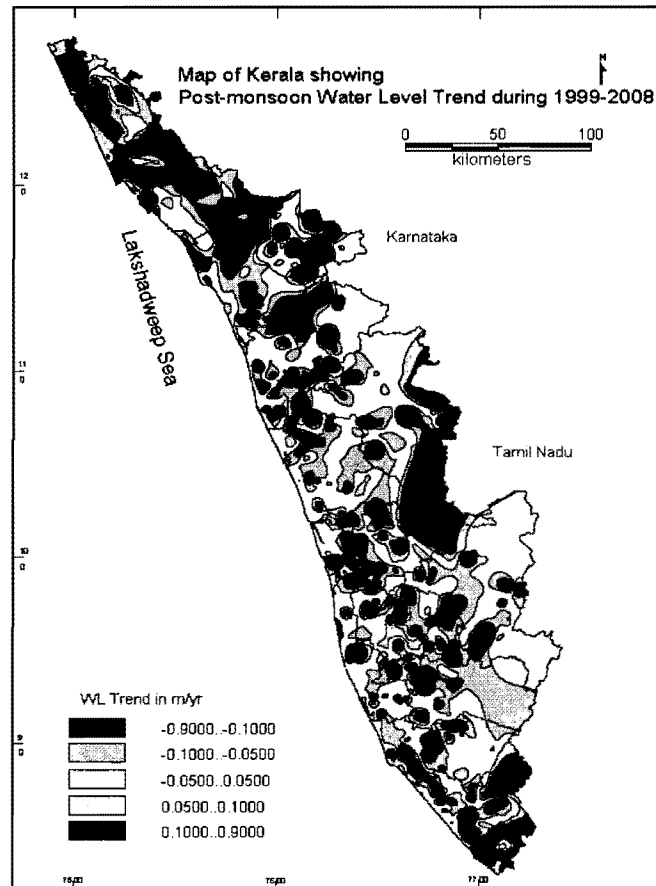

Figure 3-5 Post-Monsoon Water Level Trend for the Period 1998-2007

The hydrographs of villages in Kollam, Kannur, Wayanad, Kottayam and Palakkad districts Kerala are shown in Figures 3.6 to 3.11

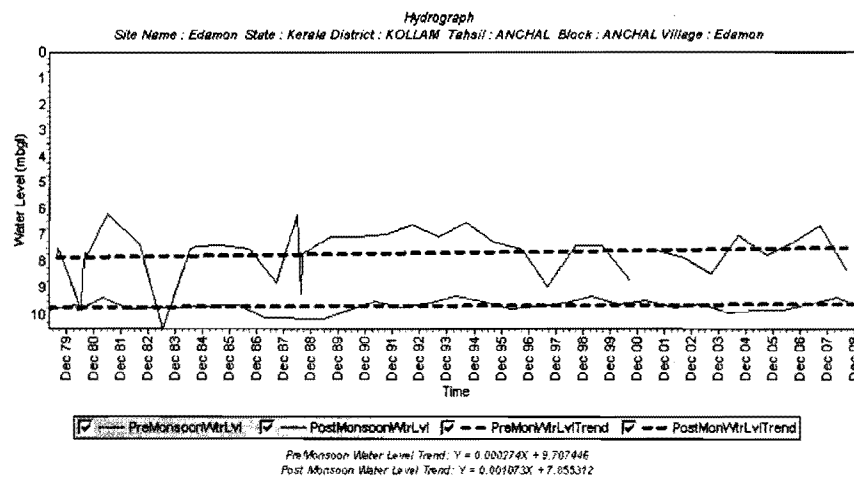
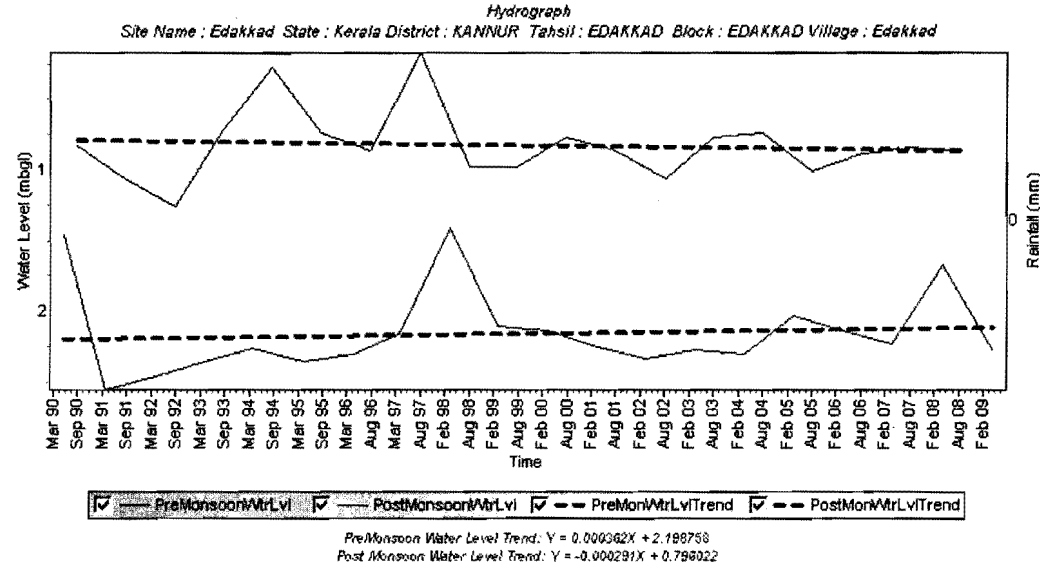
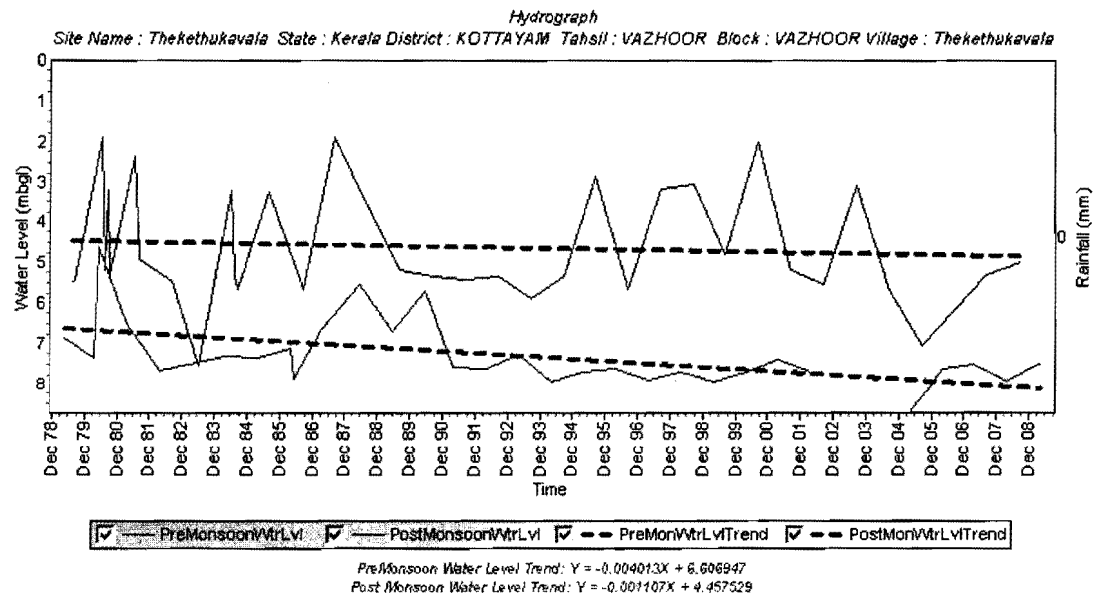

Figure 3-6 Hydrograph of GWMW Tapping Phreatic Aquifer in Laterites at Edamon, Kollam District





**Figure 3-7 Hydrograph of GMMW Tapping Phreatic Aquifer in Laterites at Edakkad, Kannur District**



**Figure 3-8 Hydrograph of GMMW Tapping Phreatic Aquifer in Laterites at Thekethukavala, Kottayam District**

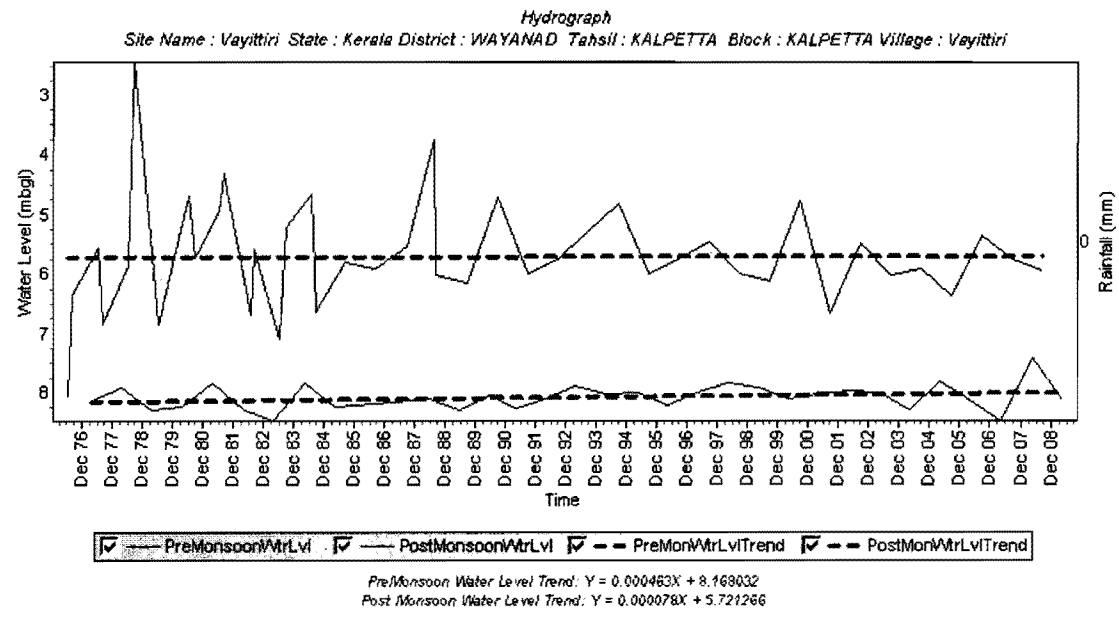

Figure 3-9 Hydrograph of GWMW Tapping Phreatic Aquifer in Laterites at Vayittiri, Wayanad District

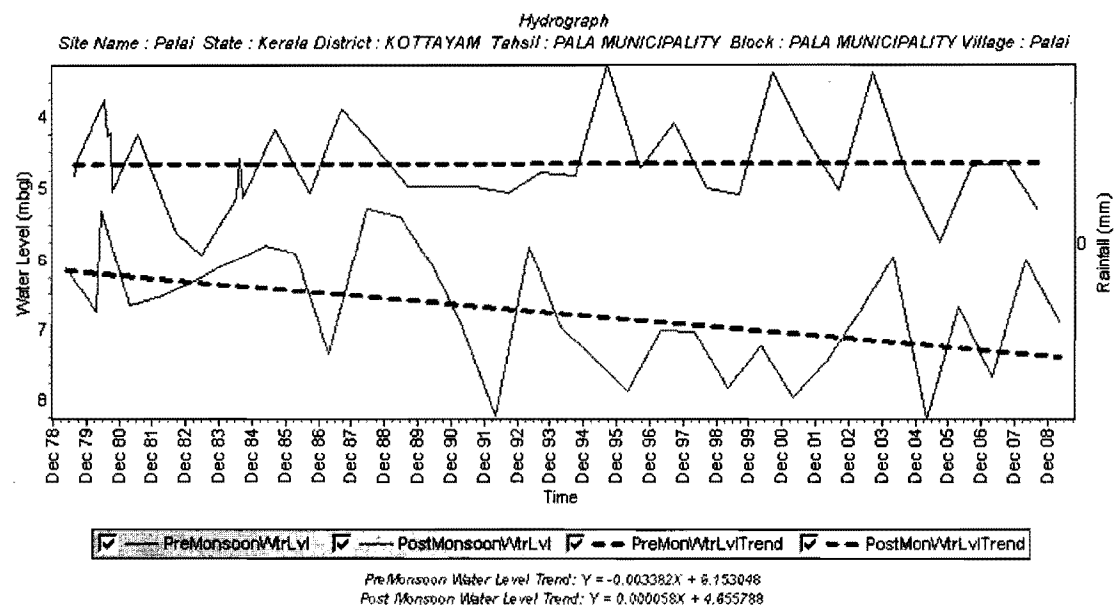

Figure 3-10 Hydrograph of GWMW Tapping Phreatic Aquifer in Laterites at Palai, Kottayam District

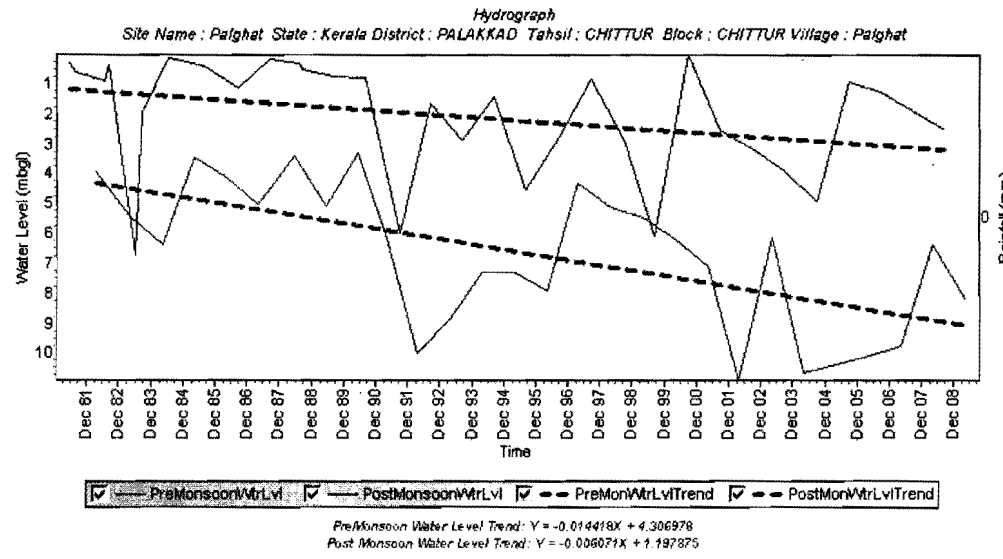

Figure 3-11 Hydrograph of GMMW Tapping Phreatic Aquifer in Weathered Crystallines at Palakkad District

From the hydrographs shown, it is observed that Edaman Village in Kollam District (Dec-79 to Dec-08), Edakad Village in Kannur District (Mar 90 to Feb 09) and Vayittri Village in Wayanad District (Dec 76 – Dec 08), the water table level is almost stable during premonsoon and post monsoon periods. There is no appreciable rise or fall irrespective of water table.

From the hydrographs of Thekethukavala Village and Palai village in Kottayam District (Dec 76 – Dec 08), Chittur village in Palakkad District (Dec 78 – Dec 08), continuous fall of water table is observed. This shows the extraction of ground water is more for agricultural and industrial purposes.

3.2.2.4 Categorization of Blocks

Out of 151 numbers of assessed blocks, 5 blocks are Over- exploited, 15 blocks are Critical, 30 are Semi-critical and 101 blocks are Safe. The long-term water level trends of pre and post-monsoon were taken to categorize the blocks. Some of the blocks have shown a lesser stage of development but the groundwater level is showing a sharp decline some times more than 10 cm/year. Table 3.6 gives the district wise break up of categorization of the blocks and its pictorial representation are given in Figure 3.12. The stage of ground water development and water level trend for the selected District and the block-wise figures are given in Annexure 3.

Table 3-6 District Wise break Up of Categorization of the Blocks WRT Ground water Utilization

S.No	District	No. of blocks in each category				Total
		Safe	Semi critical	Critical	Over exploited	
1	Thiruvananthapuram	7	2	2	1	12
2	Kollam	9	4	-	-	13
3	Pathanamthitta	9	-	-	-	9



S.No	District	No. of blocks in each category				Total
		Safe	Semi critical	Critical	Over exploited	
4	Alappuzha	12	-	-	-	12
5	Kottayam	11	-	-	-	11
6	Idukki	5	2	1	-	8
7	Ernakulam	7	4	4	-	15
8	Thrissur	12	4	-	1	17
9	Palakkad	6	2	3	1	12
10	Malappuram	5	8	1	-	14
11	Wayanad	2	1	-	-	3
12	Kozhikode	8	1	2	1	12
13	Kannur	7	-	2	-	9
14	Kasargod	1	2	-	1	4
<b>Kerala State</b>		<b>101</b>	<b>30</b>	<b>15</b>	<b>5</b>	<b>151</b>

Source: Dynamic Ground Water Resources of Kerala, Ground Water Department & Central Ground Water Board (2008)

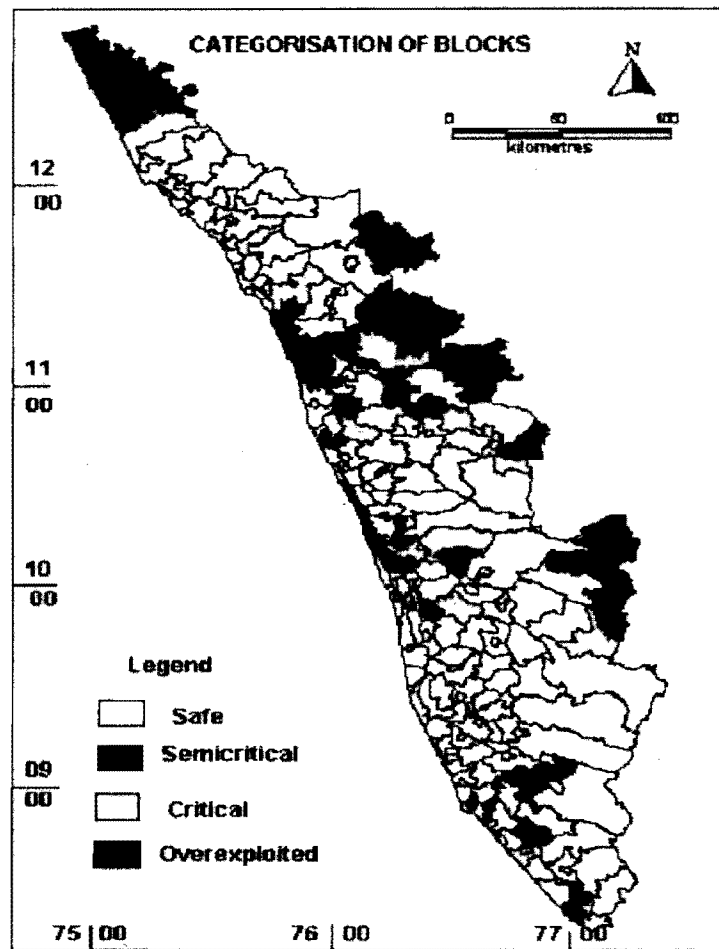

Figure 3-12 Categorization\*of the Blocks

*Category	Safe	Semi critical	Critical	Over exploited
Stage of development	<70%	70-100%	90-100%	>100%

Source: Dynamic Ground Water Resources of Kerala, Ground Water Department & Central Ground water board. (2008)

#### Implications for EMF

- Integrated water shed management at micro level to enhance ground water recharge, minimize soil erosion and promote green cover.
- Guidelines for sustainability of ground water sources are given in Annexure 11.
- Appropriate legislations to be enforced to regulate ground water abstraction/prevent water mining and minimize wasteful consumption.

### 3.2.3 WATER SCENARIO IN KERALA

Though Kerala is endowed with 44 rivers tanks and wells, backwaters, innumerable rivulets and streams, highest rainfall, yet there is problem related to water throughout the State. The annual yield of water in Kerala in normal year is around 7030 crore CUM. The ground water resource available in Kerala is estimated at 7048 MCM. As per rough estimate of projected demand, 3000 crore CUM is required for agriculture, 750 crore CUM for domestic use, 1220 crore CUM for prevention of salt water intrusion. The total requirement is 4970 crore CUM. Nearly 40 % of available water resources are lost as run off. The pattern of demand is also undergoing gradual but continuous changes towards increasing pressure for drinking and other domiciliary needs and decreasing demand for irrigation. Specific problems in the study area are presented as Annexure 4.

Major problems related to water are

- Saline water ingress in shallow alluvial aquifer in coastal areas
- Water logging in areas bordering backwater lagoons during rainy seasons
- Acute water scarcity in many districts during summer months
- Groundwater contamination due to effluent discharge from industries, solid waste dumping and improper sanitation
- Contamination of surface water due to direct discharge of effluent into water body
- Tapping of deep confined aquifer for drinking water supply resulting in excess fluoride concentration in water.
- Extension coastal erosion leading to degradation of groundwater quality
- Pesticide contamination in surface waters of Kasargod District
- Iron contamination is found throughout the State but more predominant in Palakkad, Kozhikode, Thrissur, Kasargod and Kollam Districts
- Nitrate contamination is predominant in Malappuram and Kannur Districts
- Bacteriological contamination is seen through out the State.

The **Figure 3.13** shows the prominent environmental hotspots of chemical and biological contamination in the State. The **Table 3.7** gives an overview of the contaminated habitations in all the Districts in Kerala with respect to Fluoride, Arsenic, iron, Salinity and Nitrate. The **Table 3.8** presents the quality of well water in selected places in Kerala. During site visit water samples were collected and analyzed for quality. The analysis reports are presented as **Annexure 5**.

Results of Analysis reports

- Bore well samples collected from Kottukal coastal area, Eruthenpathy (ward 1) are high in TDS and require some treatment for TDS removal.
- Water samples collected from Moolakara (Kottukal) canal, Kurumana well, Kaniyanthodu (Thirukovilvattam), Velayani lake, Ezhupunna market bore well, Aanithara well (Wayanad), Janakiya well (Malappuram), Puduchola well (Sulthan Bathery), Kanjambadi bore well (Enmakaje), Chanakuzhi bore well, Mupli bore well (Kodom Belur) have higher levels of iron & turbidity. Proper treatment has to be provided for removal of iron from these sources.
- Samples collected from Moolakara canal (Kottukal), Manichera well (Sulthan Bathery), have higher levels of nitrate and require removal of the same for the source.
- Samples from Velayani lake (Kaliyoor) & Kongerithodu (Ezhupunna) indicate organic contamination, due to increased COD values.
- Samples collected from bore well of Eruthenpathy (Ward-1) indicate higher values of fluoride and needs defluoridation.
- Samples collected from open well & pond in Eriyad, open well in Enmakaje, open well in Jawahar Colony (Sulthan Bathery) is well within the limits as per IS10500:1991 and can be used as such.

Table 3-7 Groundwater Quality Affected Habitations

District	Contamination wise number of Habitations					
	Total	Fluoride	Arsenic	Iron	Salinity	Nitrate
Alappuzha	160	38	0	21	101	0
Ernakulam	26	1	0	16	9	0
Idukki	21	1	0	14	0	6
Kannur	91	0	0	71	4	16
Kasargod	101	0	0	81	17	3
Kollam	74	0	0	65	9	0
Kottayam	5	0	0	1	4	0
Kozhikode	98	0	0	80	17	1
Malappuram	63	0	0	41	2	20
Palakkad	217	60	0	150	7	0
Pathanamthitta	12	0	0	0	12	0
Thiruvananthapuram	32	9	0	22	1	0
Thrissur	94	0	0	83	11	0
Wayanad	24	0	0	17	0	7
<b>Total</b>	<b>1018</b>	<b>109</b>	<b>0</b>	<b>662</b>	<b>194</b>	<b>53</b>

Source: DWSS Website



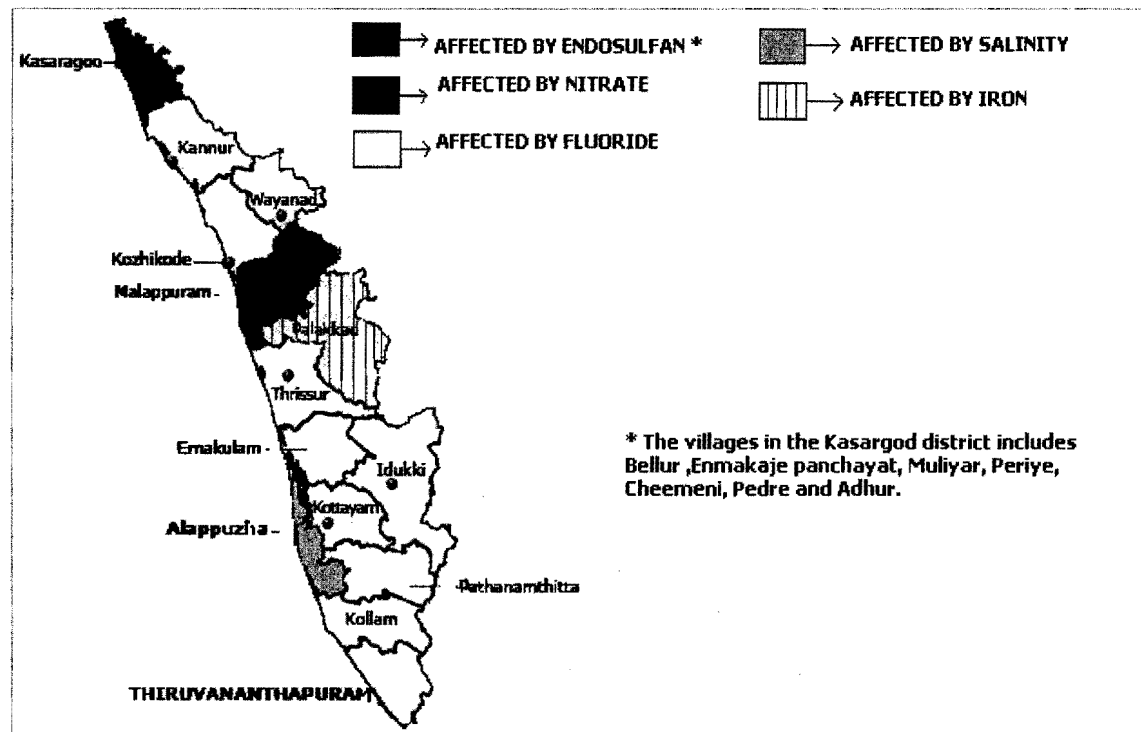

Figure 3-13 Environmental Hotspots of Groundwater Contamination in Kerala

**Implications for EMF**

- Improvement of drainage courses to ensure effective drainage by channeling the flood flow.
- Disinfection of water to eliminate organic contamination.
- Periodical maintenance of OHT, pipelines and pumps to ensure continuous supply of water.
- Programme related to hygiene education & awareness to keep the area around traditional water sources clean is essential.
- Defluoridation technologies to be adopted in fluoride contaminated areas.
- Iron removal plants to be installed in areas affected by iron.
- RO plants to be installed for removal of TDS/ salinity.

Table 3-8 Water Quality of Wells in Kerala

S. No	Station	pH	Cond mhos/cm	BOD mg/l	Nitrate N (mg/l)	TC/100 ml	FC/100ml
1.	Open well near national highway in pappanamcode. Nemom village, Thiruvananthapuram	5.2-5.5	200-220	0.6-1.1	0.4-1.7	10-90	0-2
2.	Well at Nedumangad, near Nedumangad govt.hospital in Thiruvananthapuram district.	6.5	184-300	0.6-1.9	0.6-1.76	10-60	0
3.	Open well near Kundara ceramic factory in Kollam district.	4.8-5.1	148-182	0.8-2.3	3.2-4.9	540-880	350-400
4.	Open well near KMML. Chavara, Kollam district.	7.4-7.9	495-2360	0.6-0.8	1.5-6.8	400-1800	240-860
5.	Well located at Kureepuzha near Chandy depot Kollam	6.5	238-543	0.4-0.7	4.1-8.2	280-1000	140-170
6.	Well station located at Punalur near Kallada river in Kollam district.	4.5-5.9	298-400	0.4-0.7	2.9-9.4	170-440	130-210
7.	Public well located near Fathimapuram municipal waste dump site in Prunna village, Changanassery taluk in Kottayam district.	6.5-7.2	111-273	0.2-0.4	0.4-0.7	10-700	3-500
8.	Open well at Lalam village, Meenachi taluk in Pala municipality in Kottayam district.	5.9-6.4	66-110	0.3-0.4	0.9-2.9	10-90	6-60
9.	Public well located in Nadavilla Village, Vaikom municipality near Vaikom municipality waste dumpsite.	5.4-7.2	1.6-111	0.3-0.5	1.06-3.5	160-500	100-400
10	Public well located at Vadavathoor in Vijayapuram village, Kottayam taluk near Kottayam municipality waste dumpsite.	5.4-7.2	1.6-111	0.3-0.5	1.06-3.5	160-500	100-400
11	Open well station at Cherthala in Cherthala village Alappuzha district.	7-7.6	152-153	1.2-2	0.46-0.5	330-700	50-240
12	Open well located at sarvodayapuram, in	7-7.1	180-192	0.5-1.2	0.22-0.6	240-1600	50-400





	Kalavoor Panchayat near municipal dumpsite yard of Alappuzha municipality.						
13	Well located at Vytilla in Kochi corporation in Ernakulam district.	6.8-7.2	468-523	1.1-1.5	2.56-7.6	10-850	0-420
14	Open well located at Edayar near industrial area in Kadungalloor Panchayat in Ernakulam district.	5.4-6.2	174-192	0.4-0.5	2.6-3.2	80-310	0-140
15	Well at Brahmapuram in Vadavukode Puthencruz Panchayat in Ernakulam district near municipal solid waste treatment yard	6.3-6.6	372-900	1.2-1.8	0.56-1	280-1600	120-340
16	Tube well located at Ambalamugal in Aadavucode-Puthencruz Panchayat in Ernakulam district near TSDF site.	6	173-668	0.3-1.2	0.005-0.1	160-1260	80-700
17	The well station is located at Eloor in Eloor Panchayat Ernakulam district.	5.5-7.1	116-249	0.3-0.7	1.5-3.06	0-20	0-10
18	Open well located at Kalamassery in Kalamassery municipality near to NH 47 in Ernakulam district.	4.8-4.9	180-286	0.8-1.2	0.6-8.4	6-80	0-10
19	Well at Poolkunnam in Thrissur corporation.	6-6.4	92-118	0.4	2.1-2.48	30-370	0-220
20	Well at Laloer in Ayyanthol near the dump site in Thrissur corporation.	5-5.1	54-260	0.5-0.65	0.6-12	260-640	160-380
21	Open Well in Ollur Village, Thrissur Corporation located in the Market Place.	4.7-5	200-240	0.6	7.4-10.5	70-420	20-240
22	Public well in Karukamoni, Chittoor Taluk in Palghat District.	6-6.9	6.9-735	0.4-0.7	0.3-2.7	300-500	110-300
23	Partially Covered Well at Malappuram in Malappuram Down Hill Market Area	5.4-5.8	290-560	0.3-0.5	0.4-0.61	720-1000	200-380
24	Well Located in Government HSS	5.5	119-210	0.45-0.7	0.3-0.98	320-620	60-120
25	Public Well Located in Mavoor Panchayat in Kozhikode District	5.5-6.1	8.9-134	0.4	0.1-1.5	40-300	0-110
26	Public Well Located in	5.9-6.3	101-119	0.4-0.5	2.7-3.3	220-	120-140

	Mavoor Panchayat in Kozhikode District					240	
27	Well Station Located at Kannur Taluk Kannur District	4.6-4.8	100-162	0.7-0.9	0.9-1.8	200-700	0-70
28	Well at Payyannur In Vellur Village, Taliparamba Taluk, Kannur District	5.6-5.7	180-229	0.4-1.6	2.2-4.1	200-600	80-250
29	Open Well Located at Chellora Panchayat Near Chellora Trenching in Kannur District	4.7-5	50-90	0.2-0.4	1.19-1.8	0-80	0
30	Open Well Near Punnelpettipalam in Thalasserry Taluk in Kannur District	5.6-6.4	92-268	0.4-1.1	2.1-8.3	30-700	0-150

Source: Water & Air Quality Directory, 2009

### 3.3 SOLID WASTE GENERATION AND MANAGEMENT

Kerala is a State considered to have a developed modern society. The huge consumption of resources results in the generation of large quantity of waste. All types of waste including solid, hazardous and biomedical waste generation in the State are more in terms of quantity compared to other States in the country. Series of actions initiated at National and State level abate the problems arising due to the wastes, particularly the pollution problem.

Solid waste generation is mainly due to industrial and domestic activities. The waste generated due to industrial activities is of hazardous as well as non-hazardous nature. The biomedical wastes are generated from all health care institutions. The responsibility of collection, treatment and safe disposal of all types of solid wastes rests with the generator.

Even though there are 58 urban municipalities in the state, most of the Gram Panchayats depict the characters of urban areas particularly in respect of Municipal Solid Waste generation. Therefore, the state should plan to have Municipal Waste Management systems in all the Gram Panchayat areas.

#### Implications for EMF

- Awareness on solid waste segregation at the source among the public should be created.
- Solid waste should not be dumped into water bodies. It should be processed and disposed properly.

#### 3.3.1 CATEGORIES OF SOLID WASTE

##### a) Municipal Solid Waste

The quantity of garbage generated in the State is about 12731 T/day. This includes wastes generated from all Municipal Corporations, Municipalities and Gram



Panchayat areas. The different treatment and disposal options followed in Kerala include the following

- Open dumping
- Land fill
- Vermi-composting
- Aerobic Composting
- Trenching

The Municipal Solid Waste quality is similar in all areas but its quantity varies. There are cases of biomedical waste, industrial waste and hazardous waste mixing with MSW. Generally, no segregation of MSW is practiced. However, in certain urban areas like Kozhikode Municipal Corporation an attempt is being made to segregate the waste.

**b) Biomedical Waste Generation**

It is roughly estimated that about 1.3 to 2.0 kg/bed/day of solid wastes are generated from health care institutions of which 15 to 20 % are biomedical waste. The number of beds in government and private institutions are about 40000 and 58000 respectively. About 1.5 lakh kg/day of solid waste is generated from the hospitals and other health care centers in the state. The Distribution of solid waste from Health Care Institutes in Kerala is shown in **Figure 3.14**.

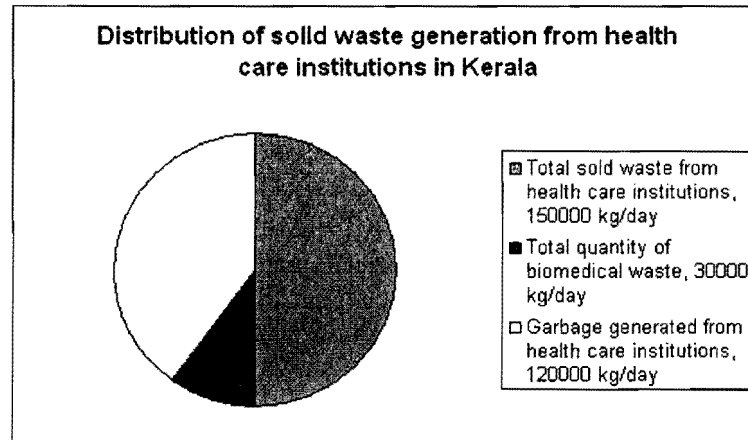

**Figure 3-14 Distribution of Solid Waste from Health Care Institutes in Kerala**

**c) Hazardous Waste**

Industrial hazardous waste quality and quantity is based on the type of source. Industrial solid waste and Effluent Treatment Plant (ETP) sludge are not properly disposed. Waste generated from conventional industries like coir and cashew also causing problems.

According to the pollution potential, hazardous wastes handling units are classified into three categories namely red category (highly polluting), orange category (medium polluting) and green category (less polluting). The distribution of hazardous waste handling units as per the category wise classification is shown in **Figure 3.15**.



Figure 3-15 Category Wise Distribution of Hazardous Waste Handling Units in Kerala

(Source: www.kerenvis.nic.in)

### 3.3.2 IMPACTS

#### a) Municipal Solid Waste

The improper disposal of municipal solid waste at the disposal/dumping sites attracts rodents, flies, etc. apart from this the open dumping of wastes create an unhygienic condition.

#### b) Soil Contamination

The unscientific management of municipal solid waste will lead to contamination of soil. The contamination of soil was reported from a few MSW dumping sites. The soil purification activities cannot be dreamt at the present level of economic condition of the State.

#### c) Ground water Contamination

The contamination of soil, in turn, leads to contamination of ground water. This is mainly due to percolation of leachate. The quantity of leachate will be more in Kerala due to heavy rainfall. Once the ground water is polluted it may take decades to attain the normal condition. Some studies show that ground water contamination is observed near some waste dumping yards.

### 3.3.3 HEALTH PROBLEMS

The open dumping areas can create health problem, as it will lead to multiplication of rodents and flies. Open dumping may result in the generation of anaerobic gases, which lead to creation of bad odour primarily resulting in a variety of diseases. There are persistent complaints from people residing near open dumping areas. Health care establishment premises with poor solid waste management are more prone to spreading diseases.

#### a) Hazardous Waste

Improper and unscientific disposal of hazardous wastes results in adverse impact on ecosystem including human health. In absence of common hazardous waste handling facilities in the State the industrial units generating hazardous waste are presently storing the wastes in their own premises.

**b) Soil Contamination**

Once hazardous wastes are disposed on land toxic metals, oils and toxic chemicals will contaminate soil. It is reported that some toxic organic chemicals can affect the soil productivity.

**3.3.4 SITE VISITS TO EXISTING FACILITIES**

Solid Waste Management in the Gram Panchayats is very poor and the GPs like Pampakuda, Thirukovilvattam the main problem of water contamination and health aspects is the poor solid waste management. In Ramanattukara GP, Kozhikode the process of Incineration was there and presently it is not under working condition. In Sulthan Bathery GP of Wayanad District Incineration is practiced using Incinerators. The process of Incineration is banned as per the Municipal Solid Waste (Management and handling) Rules, 2000.

**3.3.5 EXAMPLES OF SOLID WASTE MANAGEMENT IN KERALA****Success Story No.1**

***Solid Waste Management in Mangalapady Village Panchayat in Kasargod District- An example of Multi-Village Panchayat Partnership.***

The Clean Kerala Mission assisted Mangalapady Village Panchayat in establishing a waste processing plant using Vermi composting and Biomethanation. As the plant had sufficient capacity, adjoining Panchayats of Kumbala and Mugral-puthur have joined with Mangalapady. These Panchayats send their waste to the processing plant in Mangalapady paying Rs.0.70 per kg as fee. In return they get 25% of the organic manure generated by the waste supplied by them. Another innovation is the contracting out of the management of the plant to Kasargod Social Service Society, a local NGO of repute which takes 30% of the profit generated by sale of organic manure. This is an excellent example of what Village Panchayats can do in future – to come together to set up common facilities and share the costs as well as the benefits.

***Result***

Local NGO of repute helped Multi – Panchayats to process MSW into aerobic composting on payment basis.

***Lessons Learnt***

Village Panchayat have coordinated actively with NGO who has expertise in Composting (Aerobic / Vermi Composting) to convert solid wastes into compost.

***Information useful for Jalanidhi -2***

Projects on Sanitation (MSW Treatment and Disposal as a whole) under Jalanidhi – 2 can be successfully implemented to convert solid waste into compost with the help of NGOs which will be beneficial to the community.

**Success Story No.2**

***Decentralized Solid Waste Management in Alappuzha Municipality- an example of community based Solid Waste Management in an urban situation.***

Alappuzha Municipality has 50 Wards and 32,203 households spread over 47 Km<sup>2</sup>. With only about 50% of the 65 to 75 tonnes of waste generated every day being



transported to the dumping yard in the adjacent Panchayat, the remaining waste spilled over into the beautiful ancient Venice like canal system of the town converting it into one of the most insanitary towns in the State. Here again the Municipal Council and Socio Economic Unit Foundation, an NGO, got into a partnership and initiated an Action Research Programme called "Women, Well Being, Work, Waste and Sanitation (4 Ws). After a small pilot project, six wards were identified covering 5624 households. The baseline survey indicated that only 10% of the households segregate their waste; 58% of the households burned their waste, while 16% threw them into their backyards and 15% resorted to dumping them in public places. Thus, the challenge was quantified. Technical Committees and Popular Committees were set up and the strategy of participatory social engineering was employed. The elements of the programme included the following:

- Reduction at source
- Segregation at source
- Collection and sale of recyclables
- Household level processing of organic waste.
- Substitution of plastic bags with cloth and paper bags.
- Community policy to prevent people from violating the code of clean.

#### **Result**

In a short span of time, 3350 households started vermi-composting. In 35 places common vermi-compost units were set up. Nearly 2000 families started organic farming in their compounds. Three Paper Bag units have been started along with two Plant Nurseries. Through public action 8 kms of canals and 12 ponds have been cleaned and rejuvenated. The Alappuzha experiment has shown that through social engineering involving committed professionals and elected leaders, even in an urban setting, community behavior can be changed for the better.

#### **Lessons Learnt**

Focused effort of committed professionals along with elected leaders provided a commitment for implementation of MSW project.

#### **Information useful for Jalanidhi - 2**

Jalanidhi - 2 can avail assurance from professionals and elected representatives so as to have a potential will for speedy implementation of Solid Waste Management project.

#### **Success Story No.3**

***Introduction of door to door collection in Kozhikode Corporation- An example of a socially beneficial outsourcing to a Community Based Organization of poor women.***

Kozhikode city faced public uproar and even unrest over the overburdened dumping site, as waste of all kinds reached the end point, totally unsegregated. With a city having 72855 households and about 12,000 commercial establishments, the problem seemed insurmountable. The City Corporation had the option of either increasing their staff or privatizing door to door collection. But it chose the third way of opening a business opportunity for the poorest of the poor. It decided to outsource door to door collection to the Kudumbashree network of women below poverty line. 75 micro enterprise groups were set up with each group having 10 members. They were trained



and provided a total subsidy of Rs.90 lakh and bank finance of Rs.187 lakh which was utilized for purchase of auto-rickshaws and other equipment. To motivate the households two bins one white and the other green were given to each household for keeping the waste segregated. A user charge ranging from Rs.15 to 30 per household per month was fixed, which the households gladly gave as it went to poor persons. Now 35% of the households and commercial establishments have been brought under this door-step collection system. Kozhikode town has become visibly cleaner and waste reaching the treatment site has increased by 25 to 30%. The initiative of Kozhikode Corporation has proved that, even in a big city, the Corporation can ensure proper door to door collection, if a socially sensitive approach of enhancing the livelihood of the poor is followed.

#### **Result**

Poorest of the poor gets financial assistance to improve their living conditions through this project.

#### **Lessons Learnt**

Joint effort from the local body, bank and the weaker section would help in sustainable management of MSW.

#### **Information useful for Jalanidhi - 2**

Sanitation projects of Jalanidhi - 2 for multi GPs can be handled effectively through a team comprising GP representatives, Bank and the people from the downtrodden communities.

### **3.4 ENVIRONMENTAL SANITATION**

Though Kerala has made significant improvements in the sphere of public health, the last few years has witnessed an increase in prevalence and incidence of communicable and non-communicable diseases in the state. The morbidity analysis of the state shows a high prevalence of Diarrheal diseases, Hepatitis, Pulmonary Tuberculosis, Malaria, Dengue, Japanese encephalitis etc which are increasing year by year. Details regarding the outbreak of various Water borne Diseases in Kerala are given in **Annexure 6**.

The Total Sanitation Campaign (TSC) in the state was coordinated and monitored by the Kerala Total Sanitation and Health Mission (KTSHM) and their activities were confined to the rural Panchayats. The Clean Kerala Mission (CKM) was enabling the urban and rural local bodies in establishing solid waste management systems. In order to avoid duplication of efforts and tackle the existing and emerging challenges in various sanitation aspects for an overall health and environmental outcome, it was felt necessary to have a professional institution. Accordingly, the above Missions were integrated as **Suchitwa Mission**, which started functioning since April 2008.

The challenges with regard to rural sanitation in Kerala in spite of the high level of sanitation coverage are:

- Emerging issues of solid and liquid waste management due to the urbanization of the rural areas, high density of population and the fast changing life style of the people.

- Coverage of the difficult groups and areas with household toilets i.e. high water table areas particularly in the coastal region, low lying areas like Kuttanad in Alappuzha district and tribal people living in forest areas and forest fringes.
- Coverage of landless people or those having very small holdings of land, especially those living in densely populated colonies and encroached land.
- Unsafe disposal of septage collected from the septic tanks of households and institutions by private operators, which is currently getting dumped mostly in water bodies.
- High level of bacteriological contamination of drinking water sources, due to poor sanitation.

#### Strategy

Jalanidhi – 2 will address the above challenges adopting the following strategy in the GPs to be covered during the project period.

- Jalanidhi will draw upon the experience and expertise of Suchitwa Mission to implement the sanitation component of the project. KRWSA will enter in to an MOU with the Suchitwa Mission to collaborate and get the technical support in the planning and implementation of the program.
- Jalanidhi will try to cover the gaps in HH sanitation coverage in the project GPs, by undertaking complementary social mobilization, sanitation awareness and capacity building in collaboration with Kudumbashree, NRHM and ICDS programs. In the Jalanidhi-2 GPs, the GPAT/SO team will undertake an assessment of existing household sanitation and will identify households without toilets. They will then prepare a plan for addressing the issues using the TSC funds or Plan funds of the GP and /or the funds available under the sanitation component of Jalanidhi. In the case of tribal HHs in tribal projects (TDP), the project will provide subsidy of Rs. 2500 per HH for constructing twin pit pour flush toilets.
- Reaching the uncovered population living in difficult areas would require higher levels of investment since the construction is to be carried out in difficult terrain in case of tribal and fishermen colonies where the conventional models of single or twin shallow pit toilets are not suitable. Ecological sanitation (Eco-san) can be considered as a suitable alternative thinking for water scarce and high water table areas. Urine-diversion dehydration (UDD) toilets, composting toilets etc are some methods. Effective IEC activities need to be carried out to change the mindset of the people towards the new approach.
- Suchitwa Mission has launched a pilot program in 225 GPs for Solid and Liquid Waste Management (SLWM) using the fund available under TSC for SLWM. Jalanidhi-2 will learn from this pilot and scale it up with suitable modification in the project GPs. The strategy to address the issues of solid waste is to (a) Promote community level management of bio-degradable waste through composting or bio gas technologies (b) Collection and processing of the market waste through composting or bio-methanation technologies by the GPs and (c) Non bio-degradable waste to be recycled at community level and reuse using appropriate technologies in a centralized manner.



- Regarding liquid waste, the strategy is to encourage community level decentralized waste water treatment systems in hot spots.
- Jalanidhi-2 will set up a Septage Treatment Plant (STP) for one district on a pilot basis during the project period in collaboration with LSGs. The STP will be operated by a private operator on payment basis collecting revenues from the service providers for collecting and treating the septage.

The sanitation coverage of the BPL (Below Poverty Line) families and Total Sanitation Campaign of different district were conducted by the **Suchitwa Mission** and the results are presented in **Table 3.9**.

#### Implication for EMF

- Low cost sanitation systems like pour flush latrines and septic tanks could be installed.
- Revamping existing latrines (>3 m) to prevent direct contact of human excreta with the ground water can be taken up.
- Guidelines on Solid and Liquid Waste Management are given in Annexure 17.

**Table 3-9 Sanitation coverage of the BPL families**

S.No	District	Block	Household with Toilet	Total with Toilet	Household without Toilet	Total without Toilet	Total Household	Total (1+2)	% with Toilet	% without Toilet
				1		2				
1	Thiruvananthapuram	Athiyannor	1737	4209	2588	4158	4325	8367	50.30477	49.69523
2		Nemon	2472		1570		4042			
3	Kollam	Mukhathala	3763	3763	939	939	4702	4702	80.02977	19.97023
4	Alappuzha	Veliyanad	883	2316	834	2609	1717	4925	47.02538	52.97462
5		Pattanakkad	1433		1775		3208			
6	Ernakulam	Pampakuda	1495	1495	271	271	1766	1766	84.65459	15.34541
7	Palakkad	Attappadi	1511	2469	5524	7053	7035	9522	25.92943	74.07057
8		Chittur	958		1529		2487			
9	Thrissur	Kodungallur	3951	3951	1213	1213	5164	5164	76.51046	23.48954
10	Kozhikode	Kozhikode	660	660	233	233	893	893	73.90817	26.09183
11	Malappuram	Tirurangadi	2970	2970	233	233	3203	3203	92.72557	7.27443
12	Wayanad	Sulthan Bathery	2335	2335	1442	1442	3777	3777	61.82155	38.17845
13	Kasargod	Manjeshwar	421	1301	2721	5249	3142	6550	19.8626	80.1374
14		Kanhangad	880		2528		3408			
		<b>TOTAL</b>		<b>25469</b>		<b>23400</b>		<b>48869</b>	<b>52.11688</b>	<b>47.88312</b>

Source: DWSS website

### 3.5 KEY ENVIRONMENTAL ISSUES

Groundwater has been the major source of water for drinking, irrigation and industrial uses in Kerala. Due to large-scale extraction of groundwater for irrigation, combined with increasing demands in other sectors due to population and industrial growth, the aquifers are under stress. For a large number of rural households which are dependent on dug wells, the declining and fluctuating groundwater levels are adversely affecting the water supply. There are complaints from the community that some of these sources go dry during summer season (dry period) and the public supply from various sources is inadequate. The problem is very acute in coastal areas (for eg. Thiruvananthapuram), where traditional dug well sources are saline and the service level from the existing water supply schemes is meager. Declining water table (for e.g. Palakkad) is observed to be an emerging phenomenon in some parts of the state. In cases where the water supply is from river or canal, it is adversely affected during the periods of river / canal non flow /maintenance shutdown.

The decline in water level has been confirmed in some parts of all districts of Kerala. Increase in ground water draft is the major cause for this phenomenon. It is also observed that competing demands for agricultural and domestic purpose are leading to increase use of 'pumps' for lifting water from traditional sources, in addition to bore wells. This increasing pressure of demand for water is not keeping in pace with the annual replenishable recharge of ground water reserves.

Environmental Issues specific to the study area (14 Districts) are presented in FGD Status Report **Annexure 7**.

## 4. ENVIRONMENTAL MANAGEMENT FRAMEWORK

### 4.1 INTRODUCTION

The EMF is an environmental management tool to define criteria, methodologies, tools and procedures, to be applied throughout the Jalanidhi - 2 project implementation, in order to serve people with protected water supply and to provide adequate sanitation facilities.

An analysis of the baseline environmental situation, observations during site visits, discussions with State, district and GP level functionaries as well as the Focused Group Discussions have identified the key environmental issues. These issues mainly relate to,

- a. Inadequate or disrupted water supply
- b. Bacteriological contamination of surface and ground water quality.
- c. Presence of Salinity, Iron and Fluoride concentrations exceeding the permissible levels in drinking water.
- d. Lack of sanitation facilities.
- e. Inadequate Solid Waste Management

These environmental issues need to be addressed in the project planning, design and implementation. For this purpose an Environmental Management Framework (EMF) has been developed.

### 4.2 OBJECTIVES OF EMF

The proposed Jalanidhi - 2 Project will finance investments in rural water supply and sanitation improvement schemes to serve the rural population in Kerala. The project interventions are, therefore, expected to result in public health benefits in the rural communities through improved quality and delivery levels of RWSS services. Some of the main environmental health benefits expected under the project include: increased and better quality water supply for drinking, cooking, washing, bathing and cleaning purposes; time and energy savings through providing water supply closer to homes; improvements in personal hygiene and village sanitation levels; and reduced fecal oral contamination of drinking water resulting in lower occurrence of diseases. In order to ensure that the environmental issues are systematically identified and addressed in the various stages of the implementation of subprojects, an EMF has been developed with the following objectives:

- To design a set of procedure, delineate the roles and responsibilities of various stakeholders and institutional structure in the implementation of sub projects along with the capacity building and staffing requirements for mainstreaming environmental management in project implementation processes
- To provide a systematic approach for identifying the various possible environmental impacts at the different stages of the scheme cycle
- To identify appropriate mitigation measures for addressing the identified environmental issues

#### 4.3 LIST OF REGULATORY REQUIREMENTS APPLICABLE TO JALANIDHI- 2

##### 4.3.1 WATER

- **Kerala Ground Water Act, 2002**
  - Prohibits digging of well, without permission, for any purpose within 30m from any drinking water source from where water is pumped for public purpose.
  - For extraction of ground water, energized pump with capacity not more than 1.5 HP for open wells, and 3 HP for tube wells, bore wells and dug-cum-bore wells should be used
- **Water Act, 1974**
  - Prohibition on use of stream or well for disposal of polluting matter
  - Restrictions on new outlets and new discharges into inland water bodies or on land
- **Kerala Water Supply and Sewerage Act, 1986**
  - Any person who unlawfully draws or takes or uses water from a public hydrant shall be punishable.
  - Punishment will be given to the persons for tapping or making illegal connection from main or service pipes.
- **Water Cess Act 1977**
  - Water extraction from ground or surface will include levy and collection of cess

##### 4.3.2 ENVIRONMENTAL PROTECTION

- **Environmental Protection Act 1986**
  - The Central Government has issued norms to improve the quality of environment by setting standards for emissions and discharges, regulation in location of industries, management of hazardous waste and protection of public health
- **Coastal Regulation Zone Notification, 2011**
  - Harvesting or drawal of ground water and construction of mechanisms within 200 m of HTL is prohibited.
  - Harvesting or drawal of ground water shall be permitted in the 200 – 500 m zone only when done manually through ordinary wells for drinking, horticulture, agriculture and fisheries
  - Withdrawal of ground water is permitted, where no other source of water is available in the zone between 50 to 200 m from HTL in case of seas, bays and estuaries and within 200 m from HTL in case of creeks and backwaters (when done manually through ordinary wells or hand pumps for drinking and domestic purposes) with approval from an

authority designated by the State Government or Union Territory Administration.

- **Municipal Solid Waste (Management & Handling) Rules, 2000**
  - The baseline data of ground water quality in the area shall be collected and kept in record for future reference before establishing any landfill site.
  - The ground water quality within 50 m of the periphery of landfill site shall be periodically monitored to ensure that the ground water is not contaminated beyond acceptable limit as decided by Ground Water Board or State Board or the Committee.
  - The monitoring shall be carried out to cover different seasons in a year.
  - Usage of ground water in and around the landfill sites for any purpose (including drinking and irrigation) is to be considered after ensuring its quality.
- **Kerala Municipality Building Rules 2004**
  - Rainwater harvesting arrangements has to be provided and is an integral part of all new building constructions like residential (floor area  $\geq 100\text{m}^2$  and plot area  $\geq 200\text{m}^2$ ), educational, medical, assembly, office.

#### 4.3.3 NATURAL HABITAT CONSERVATION

- **Forest Conservation Act 1980 & amendment in 1988**
  - Implication of water supply and sanitation projects in forest areas should neither affect the ecology and health of forests, nor the welfare or rights of people residing in the forests, nor management structures for protection and conservation of forests.
  - Clearance is required form Forest department, when forest land is required for project activities.
- **Wildlife Protection Act 1972, amendment 1991**
  - Kerala has 53 designated natural habitats (including 2 Biosphere Reserves, 5 National Parks, 17 Wild life/Bird sanctuaries, 1 Community Reserve, 2 Tiger Reserve & 28 Mangrove sights)
  - Activities pertaining to water supply & sanitation in these areas are to be restricted
- **Ramsar Convention, 1972**
  - Any scheme near Vembanad lake covering an area of 1512sqm, Ashtamudi lake the second largest wetland and deepest among the estuaries and Sasthamkotta lake of Kollam District are to be implemented with care to protect these lakes against contamination.

- National Wetland Conservation Programme 1985-86
  - Implementation of schemes under Jalanidhi-2 near Vembanad (Alappuzha, Kottayam, Ernakulam and Thrissur), Asthamudi (Kollam), Sasthamkotta (Kollam), Kottuli (Kozhikode) and Kadalundi (Kozhikode and Malappuram) wetlands should not affect them.
- OP / BP 4.04 Natural Habitats
  - Prohibits financing of projects involving “significant conversion of natural habitats” unless there are no feasible alternatives and requires EA with mitigation measures.
- OP / BP 4.36 Forestry
  - Require permission from Forest department, if any scheme of Jalanidhi – 2 is located in forest areas. Appropriate environmental mitigation measures have to be implemented.
  - Any felling of trees in forest / non forest area is done with the permission of Forest department and in accordance with guidelines for compensatory afforestation.

#### 4.4 LIST OF TECHNICAL GUIDELINES

The following is the list of technical guidelines / details given in the Annexure.

- Guidelines for Sanitary Survey - Annexure 8
- Guidelines for Identification of Water Supply Sources - Annexure 9
- Recuperation Test - Annexure 10
- Guidelines for Sustainability of Water Sources - Annexure 11
- Methods for Disinfection of Water - Annexure 12
- Sanitary Protection of water supply sources, wells & springs - Annexure 13
- Mitigation measures for Fluoride Contamination - Annexure 14
- Selection of Safe Sanitation Technologies - Annexure 15
- Recommended construction practice for Twin Pit Pour Flush Latrines - Annexure 16
- Guidelines for Solid and Liquid Waste Management - Annexure 17

#### 4.5 CLASSIFICATION OF SCHEMES AND ENVIRONMENTAL CODES OF PRACTICES

In order to classify the water supply schemes and to address the environmental aspects of water supply or sanitation improvement interventions, the EMF requires the basic environmental data which includes the details of water supply schemes, source of water supply, water quality problem, proposed water treatment, sanitation facilities, sillage conveyance, treatment and disposal, solid waste disposal etc.,

For this purpose, Environmental Data Sheets (EDS) for schemes on water supply, sanitation, solid and liquid waste management etc., have been formulated. The EDS will be compiled at the field data collection stage of the proposed water supply and sanitation scheme. The formats of the EDS are given in **Annexure 18**. The GPE of the RPMU fills up the EDS in consultation with the SO Engineers and BG. Later, it will be approved by SE of the RPMU.

The Schemes are classified from the environmental point of view as follows and screening tool for categorization of new schemes under Jalanidhi-2 is presented in **Annexure 19**.

- Category I (low impact),
- Category II (medium impact) and
- Category III (high impact)

The Jalanidhi-2 will also include rehabilitation of KWA implemented water supply schemes. Since these schemes are already in place, the environmental impact due to rehabilitation is not expected to be of any significant level, these are considered as Simple Schemes. However, if an impact of significant magnitude is identified they will be addressed suitably with a proper EMP. Accordingly; the projects are classified into Low, Medium and High impact category.

The next step after the categorization is environmental assessment and mitigation planning. Two possible steps are:

**Step A:** A regulatory screen or filter, based on prevailing and applicable regulations, may be applied to determine if any regulation is contravened by any aspect of the given sub-project. In case this is so, the sub-project has to be rejected or refused environmental approval.

**Step B:** This is to be taken up only if the proposed sub-project successfully passes through the regulatory filter.

The proposed number of water supply schemes under Jalanidhi -2 is as follows:

Small Water Supply Schemes	-	6018
Large Water Supply Schemes	-	10
Multi - GP Schemes (river based)	-	3
Total No. of schemes	-	6031

The environmental code of practices for water supply and sanitation for Jalanidhi-2 are presented in **Annexure 20**.

#### 4.6 ENVIRONMENTAL APPRAISAL AND APPROVAL

Based on the category under which a given sub-project is classified, suitable and commensurate environmental assessment and mitigation planning procedures should be applied. The procedures could vary for different categories.

- For low impact category (Category I), a set of very simple mitigation steps have to be incorporated in the project plan based on the environmental codes of practice and technical guidelines.
- For medium impact category (Category II), possibly a limited environmental appraisal can be undertaken either through RPMU or an environmental consultant. This may pertain to collection of information on source, sanitation, quality of water etc, and its analysis for environmental implication. Please refer **Annexure 21** for LEA format.



- For high impact category (Category III), a full-fledged environmental appraisal to be conducted through an environmental consultant. In this case, the EMF would recommend a ToR and consultant profile for hiring such an expert. Please refer the TOR in the **Annexure 22**.

The Detailed Project Report (DPR) for Category I schemes should be accompanied by the Environmental Data Sheet (EDS). The GPE of the RPMU will ensure this. The Detailed project Report (DPR) for Category II & III schemes should be accompanied by the Environmental Data Sheet (EDS) as well as the environmental appraisal. The SE of RPMU will ensure this.

Environmental appraisal study for any category of water supply scheme as specified by KRWSA shall be conducted and reported to the respective RPMU of KRWSA within a month from the date of awarding of the contract. The period required for Environmental Appraisal of individual project falling under Category III is as follows:

Field visit	- 7 days
Preparation of Report	- 15 days
Submission of report and discussion	- 7 days
Approval of the scheme	- 12 days
Total	- 41 Working days.

The **Figures 4.1 and 4.2** show the Process Flow Diagram Pertaining to Low & Medium Impact and High Impact Category Projects respectively.

Figure 4-1 Process Flow Diagram for schemes pertaining to Low & Medium Impact Category Project

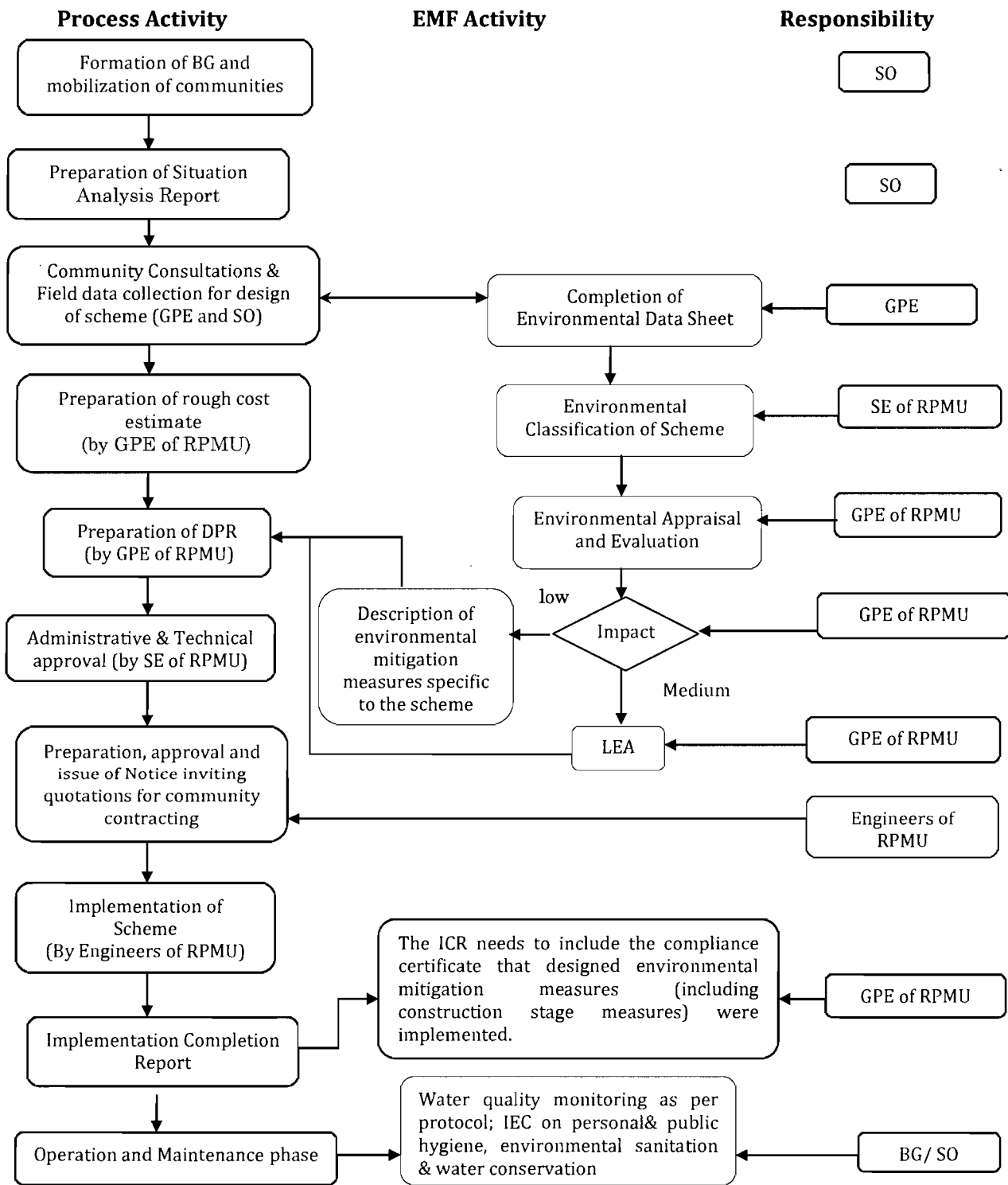
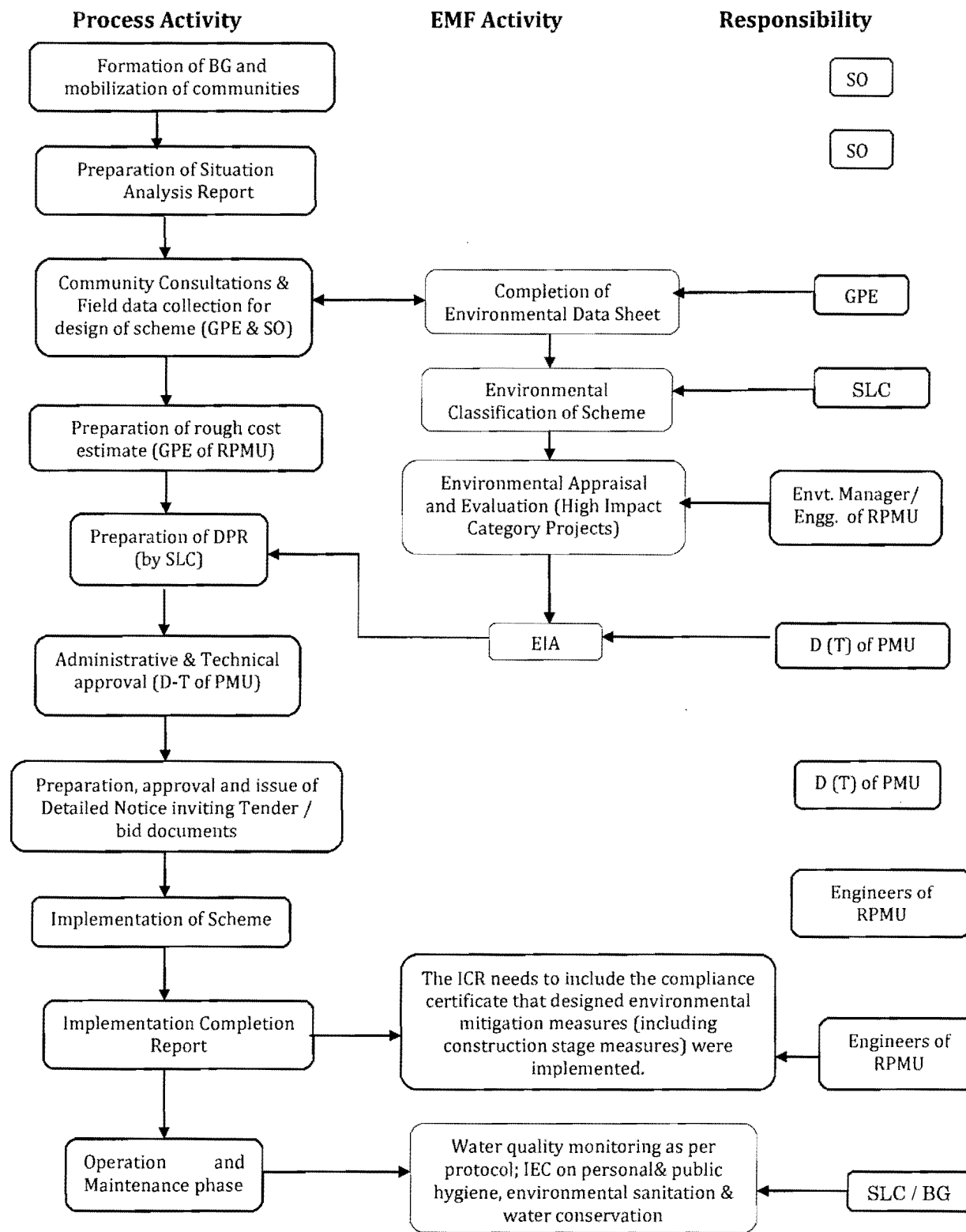

Figure 4-2- Process Flow Diagram for schemes pertaining to High Impact Category Project



**4.7 INSTITUTIONAL ARRANGEMENTS FOR ENVIRONMENTAL MANAGEMENT**

The personnel and agencies with the responsibility for environmental management will be located as follows in the project institutional structure:

1. The KRWSA will be staffed with technical unit for Rural Water Supply and Sanitation
2. The State Project Management is headed by Directors who provide guidance and technical support to RPMU Engineers
3. Each of the RPMU will be staffed with a Senior Engineer (Technical Unit) and will appoint Engineers to each of the Gram Panchayats.
4. A panel of technical experts at the State and district level will be constituted to provide technical support to PMU and RPMU.

The suggested Institutional Arrangement for implementation of EMF is presented in the **Table 4.1**.

**Table 4-1 Institutional Arrangement for the Implementation of EMF**

Level	Institution	Function	Responsibility
<b>State</b>	Kerala Rural Water Supply and Sanitation Agency (KRWSA)	<ol style="list-style-type: none"> <li>a. Ensure overall implementation of the EMF in the project</li> <li>b. Arrange funds and human resources required for implementing the EMF.</li> <li>c. Ensure that recommendations from supervision and monitoring are integrated into the project and the EMF is updated periodically as necessary</li> <li>d. Recruit external experts for conducting Environmental Audit and ensure that the relevant recommendations are integrated into the project.</li> <li>e. Selection of suitable expert for conducting detailed appraisal for Category III schemes and preparation of Detailed Appraisal Sheet with the help of RPMU to identify the environmental impacts and designing mitigation measures.</li> </ol>	D(T) of State PMU
<b>Region</b>	Regional Project Management Unit (RPMU)	<ol style="list-style-type: none"> <li>a. Carry out regular monitoring and supervision of the EMF implementation through appropriate mechanisms (and report the same to KRWSA and RPMU as necessary)</li> <li>b. Supervising the accuracy of the environmental appraisal conducted by SOE, GPE of RPMU as part of the scrutiny of the schemes including checking if the screening is accurate, if the Environmental Data Sheet</li> </ol>	SE, SOE and GPE of RPMU, District Level environmental Expert



		<p>(EDS) has been filled in as required.</p> <p>c. Evaluation of EDS and categorize the scheme into one of the categories I, II or III</p> <p>d. Conduct supervision visits to 20 % of the completed schemes twice in a year (in coordination with the SO / GPE)</p> <p>e. Provide technical advice and guidance on environmental management and environmental policies to SO, GPs &amp; BGs</p> <p>f. Ensure capacity building of all stakeholders in environmental management</p> <p>g. Design and implement IEC campaigns on environmental management</p> <p>h. Maintain a database consisting of relevant baseline environmental information of the district, environmental appraisal of the various ongoing and completed schemes, findings of supervision etc.,</p> <p>i. Coordinate with institutions, agencies and individuals relating to environmental management including the regional offices of the KRWSA, Forest Department etc.,</p> <p>j. Collect, collate and publish data on EMF implementation in the project.</p> <p>k. Environmental management and monitoring of sector projects at the GP level</p> <p>l. Sensitizing the public representatives, officials and the general public about the provisions of the EMF</p>	
<b>Gram Panchayat</b>	Supporting Organization (SO), Regional Project Management Unit (RPMU)	<p>a. Participation in preparation of Environmental Data Sheet (EDS) to be enclosed with DPR.</p> <p>b. Deliberate on environmental safeguards relevant to the schemes and adopt the same during construction and implementation.</p> <p>c. Certifying the implementation of the environmental mitigation measures as part of the Implementation</p>	President of GP/GPMU, SO, GPE, SE of RPMU

		<p>Completion Report (ICR)</p> <p>d. Facilitate IEC activities regarding water conservation, sanitation and hygiene among the villagers</p> <p>e. Liaison with forest department, KSPCB and other related departments at scheme level for ensuring implementation of identified mitigation measures (permissions, technical support etc.)</p> <p>f. Provide support to the RPMU in the supervision, monitoring and audit activities of the EMF</p> <p>g. Training should be given in conforming to the EMF requirements in operation and maintenance of Water Supply Schemes</p>	
--	--	--	--

**4.8 ENVIRONMENTAL COMPLIANCE MONITORING DURING IMPLEMENTATION AND OPERATION & MAINTENANCE PHASES**

EMF will ensure that,

- a. The prescribed environmental mitigation measures (including construction stage measures) are adequately implemented by the respective identified agency as per the responsibility matrix.
- b. Supervision, monitoring and evaluation of water quality and environmental indicators is conducted, as a part of the overall project monitoring program
- c. IEC activities are undertaken for awareness raising and sensitization regarding personal and public hygiene, environmental sanitation, and water conservation, as an integrated component of the project IEC activities.

**4.9 ENVIRONMENTAL SUPERVISION, MONITORING AND EVALUATION PLAN**

The implementation of water supply and sanitation schemes is likely to result into varying level of environmental impacts that would require supervision and monitoring. The environmental monitoring and supervision will be undertaken to,

- Ensure that mitigation measures have actually been adopted, and are proving effective in practice.
- Provide a means whereby any impacts which were subject to uncertainty at the time of preparation of this EA, or which were unforeseen, can be identified, and to provide a basis for formulating appropriate additional impact control measures
- Provide information on the actual nature and extent of key impacts and the effectiveness of mitigation measures which, through a feedback mechanism, can improve the planning and execution of future similar projects.

The list of district laboratories and contact details for water testing are presented in **Table 4-2**.

Table 4-2 District Laboratories for Water Testing with Contact Details

S. No	District Name	Lab name	Lab address	Contact name	Contact number
1	Alapuzha	QC district lab, Alappuzha	Office of the Asst.Engineer, QC District lab, Alappuzha	M.A.Joseph, AE	0477 2246650
2	Ernakulam	QC district lab, Aluva	QC district lab, pump junction, KWA, Aluva-683001	M.E.Joseph, AE	0484 2623476
3	Ernakulam	State referral institute for water quality	State referral institute, Nettoor P.O, Maradu-682040	Jolly Thomas,EE	0484 2702278
4	Idukki	QC District Lab, Painavu	QC District lab, KWA, Painavu, Idukki	Aby.M. Mundackal,AE	0486 2232388
5	Kannur	Regional lab, Kannur	QC Sub Division, KWA, Thana Kannur	Assistant Executive Engineer	0497 2704380
6	Kasaragod	QC District Lab, Kasargod	QC District Lab, KWA, Vidya Nagar Kasargod	Assistant Engineer	0499 4255542
7	Kollam	QC District Lab, Kollam	QC District Lab, QC Section, Kollam	A.Hasheer AE	9446048648
8	Kottayam	QC District Lab, Kottayam	QC District Lab, Office of the AE, QC District Lab, Kottayam.	Suresh Babu.G, AE	0481 2309911
9	Kozhikode	Divisional Lab, Kozhikode	Divisional Lab, QC Division, KWA, Malaparamba, Kozhikode-673 009	Executive Engineer	0495 2374570
10	Malappuram	QC District Lab, Malappuram	QC District Lab,KWA Kottakunnu, Malappuram	Assistant Engineer	04832738735
11	Palakkad	QC District Lab, Palakkad.	QC District Lab,KWA,Kalmandapam, Palakkad	Assistant Engineer	049102547557
12	Pathanamthitta	QC Regional Lab, Thiruvalla.	QC Regional Lab, Office of the AEE, QC Sub Division, Thiruvalla.	Roy George	0469 2625050
13	Thiruvananthapuram	QC Divisional Lab, Thiruvananthapuram.	QC Divisional Lab, QC Sub Division, Thiruvananthapuram.	P.K Sreevasan, AE	0471 2329105
14	Thrissur	Regional Lab, Thrissur.	QC Sub Division Lab, KWA, Kizhakkumpattukara, Thrissur.	Assistant Executive Engineer	0497 2704380
15	Wayanad	QC District Lab, Kalpetta.	QC District Lab, KWA, Kalpetta, Wayanadu	Assistant Engineer	0493 6202594



In Jalanidhi-1, water quality monitoring was being done three times: at the time of yield test of the source, at commissioning and third time during operation phase. The BGs were required to test the samples at least twice in a year at the nearest district laboratory of KWA. This did not happen in majority schemes. Both CCDU and TSC are carrying out IEC to create awareness about the water quality and are distributing water test kits to the schools and the community and training the students. KRWSA will also train GOK's National Rural Health Mission-ASHA workers in water quality testing as being done in other states.

In Jalanidhi-2, KRWSA will entrust KWA to monitor water quality in water supply schemes. The WQM in the project will include: (i) Anganwadi or ASHA workers will check daily for residual chlorine (ii) KWA will collect water samples at least twice in a year and analyze water quality at district level in KWA labs and inform the BGs/ GP to take corrective actions where required. Water quality surveillance will be done at local level through GOK's National Rural Health Mission- ASHA workers or Anganwadi workers and at district level by health department.

**Table 4-3 Recommended Monitoring Plan**

S. No	Monitoring	Monitoring Agency	Frequency of Monitoring
1.	External Monitoring	Independent agency	Twice in 5 years
2.	Internal Supervision	RPMU	Twice a year
3	Other Monitoring	Health Department of GoK or District. National Rural Health Mission. ASHA or Anganwadi workers.	Once every 6 months

#### 4.10 TRAINING AND CAPACITY BUILDING

The State currently has limited capacity for environmental management. The training and capacity building program developed for the project aims at building environmental awareness and environmental management capacity in the project administration structure as well as in the intended target communities. The training programs for the staff in the project agencies at various levels as well as for the village communities will be organized. The capacity building for environment management will be integrated with overall capacity building component of the project with the following objectives:

- To build and strengthen the capability of rural water and sanitation agency institutions (KRWSA, KWA) and other partners (NGOs, contractors and Supporting Organisations) to integrate sound environmental management in water and sanitation services.
- To orient the service delivery of staff and GP representatives to the requirements of the projects' Environmental Management Framework.
- Systematic capacity building initiatives will be introduced only after the completion of training needs assessment.
- The training will be of Cascade mode. All the trained staff and other will in turn conduct further trainings at State, District and Gram Panchayat levels for improved service delivery.



Both SO engineers and engineers employed by KRWSA to work in the project in GPs, Regional and state PMUs will require capacity building for survey, design, preparation of designs, drawings and cost estimates for the water supply schemes by using computer-oriented tools. Apart from other institutions, KRWSA will use the services of KWA for training of engineers.

#### **4.10.1 TECHNICAL TRAINING FOR ENVIRONMENTAL MANAGEMENT**

A specific training program for the key officials of the project, focused on the procedural and technical aspects of environmental assessment and management will be developed. This training would be mandatory for the BG, SO Engineers and GP Engineers and SE of RPMU and SPMU. The training will involve initial orientation, main training program and refresher training programs. The main and refresher training programs will be for duration of 2-3 days each, where as the initial orientation workshop will be of duration of one day.

Some specialized institutions identified for training are

- CWRDM : Centre for Water Resources Development and Management
- CGWB : Central Ground Water Board
- DSTE : Department of Science, Technology and Environment (Govt of Kerala)
- GWD : Ground Water Department (of Kerala)
- KSPCB : Kerala State Pollution Control Board
- KWA : Kerala Water Authority
- KRWSA : Kerala Rural Water Supply and Sanitation Agency

#### **4.10.2 DETAILS OF TRAINING PROGRAMMES**

The various training programmes along with the details are presented in the **Table 4.4**. The number of training programmes is presented in **Table 4.5** and the estimated cost of Training in **Table 4.6**. The budget for Environmental Management activities under the proposed project has been worked out as 6.22 crores and detailed in **Table 4.7**.

Table 4-4 Training Programmes

S. No	Training	Purpose of the Training	Participants	Schedule	Course content
T1	Introduction to Environmental Management in Jalanidhi-2 including EMF	<ul style="list-style-type: none"> <li>a. Filling of EDS, procedural &amp; technical aspects of Environmental Assessment.</li> <li>b. To equip with knowledge and skills necessary for undertaking environmental appraisal as per the requirements of the EMF.</li> <li>c. To undertake periodic supervision of environmental performance of schemes</li> <li>d. To prepare for planning and monitoring implementation of environmental mitigation measures identified through the appraisal process.</li> <li>e. To equip with skills necessary for water quality testing using the field kits under the Community based System for water quality Monitoring and Surveillance.</li> </ul>	<ul style="list-style-type: none"> <li>1. Engineers from SO</li> <li>2. GP engineer from RPMU</li> <li>3. Senior engineer of RPMU</li> <li>4. Resource personnel</li> </ul>	<p>Orientation - 1 day</p> <p>Main &amp; Refresher Training Programme - 3 days</p>	<p>Environment aspects pertaining to sustainability of water sources, water quality, treatment technologies, protection of sources for SWSS, Multi-GP schemes, besides sanitation facilities and Environmental appraisal. Water quality monitoring, Prevention of pollution &amp; surveillance.</p>

**Other Training programs on Water Quality and Environmental Sanitation**

This training program will focus on aspects such as Source selection, water quality monitoring, construction of latrines and safe disposal of sewage, municipal solid waste handling, Operation and maintenance of water supply schemes etc.

Participants - BG, SOE, GPE of RPMU

**Thematic Training Programmes**

Thematic training programmes will be conducted for three years focused on the themes 'Solid Waste Management and Sanitation Aspects', 'Water Quality Aspects' and 'Operation and Maintenance'. Training will be conducted by selecting limited number of Engineers (60 engineers for each theme/ year) for three days (orientation - 1 day and 2 days-main training programmes). Accordingly, the cost for thematic training programmes has been estimated to be around Rs.8,10,000.

**Table 4-5 Number of Training Programmes**

S.No	Topics	Number of Training Programmes	No of Years	Total No. of Trainings
T1	Introduction to Environmental Management in Jalanidhi- 2 including EMF	6 trainings /year for 1 year 4/year from 2 <sup>nd</sup> to 5 <sup>th</sup> year	5	22
T2	Thematic Training	3 training programmes and equal number of refresher training/year	3	18

**Table 4-6 Estimated Cost of Training**

S.No.	Training	No of Programs	Estimated Unit Cost in Rs	Total Cost in Rs
1	T1	22	1,22,000 <sup>1</sup>	26,84,000
2	T2	18	30000	5,40,000
<b>Sub total</b>				32.24,000
<b>Course Material Preparation</b>				5,00,000
<b>Total Cost</b>				37,24,000

<sup>1</sup> Training cost includes TA/DA for the trainees, remuneration for Resource Personnel, accommodation and food, course material.

#### 4.11 BUDGET FOR EMF IMPLEMENTATION

The total expected budget for Environmental activities under the proposed Jalanidhi-2 scheme is found to be 1.35 crores and is detailed in **Table 4-7**.

Table 4-7- Budget for Environmental Management

S.No	Activity	Amount (in Crores)
1	Training	37,24,000
2	Internal supervision visits* @ 2 lakhs / year for 5 years	10,00,000
3	Environmental Audit by the external agency twice during the project period @ Rs. 10 lakhs / audit	20,00,000
4	Preparation of specific environment related community awareness materials at state level	5,00,000
5	EA for schemes @ 10 lakhs per year for 5 years	50,00,000
	Sub Total	1,22,24,000
	Contingencies @ 10 %	1222400
	<b>Total</b>	<b>1,34,46,400</b>

\*Internal visits will be done for low and medium impact projects by SE of RPMU and by SLC or D (T) of PMU for high impact project during EMF implementation.

#### 4.12 SUMMARY OF EMF

The following **Table 4.8** summarizes the application of the EMF to the scheme-cycle, indicating the EMF activities, and corresponding objectives, processes, responsibilities and the decision results.

Table 4-8 Environmental Management Framework

Phase	EMF Activity	Objectives	Process	Responsibility	Result
Pre-Planning/ Planning	Environmental Data Sheet	To collect basic information on environmental aspects of the proposed scheme.	Discuss scheme with community and identify environmental issues of concern.	SO, with assistance of GPE/RPMU	Environmental data sheet furnished, and attached to Detailed Project Report(DPR)
			Complete EDS with supplementary notes, if required.	Compiled by GPE and approved by SE of RPMU.	
	Environmental Classification of Scheme	To ensure that schemes with potentially significant environmental or public health issues are identified at an early stage, for independent environmental appraisal.	Evaluate all the available information on environmental aspects as provided in the Environmental Data Sheet, and based on the level of expected environmental and public health impacts, assess whether the proposed scheme is Category I (low impact), Category II (medium impact) or Category III (high impact).	GPE and SE of RPMU.	Scheme classified as Category I or Category II or Category III.

Phase	EMF Activity	Objectives	Process	Responsibility	Result
	Environmental Appraisal and Approval	To ensure that relevant environmental issues have been identified and appropriate mitigation measures have been designed to address them.	<ul style="list-style-type: none"> <li>For category I schemes, simple mitigation measures will be implemented.</li> <li>For category II schemes, limited Environmental Assessment procedures will be required.</li> <li>For category III schemes, full-fledged environmental assessment has to be prepared by environmental experts selected by RPMU.</li> </ul>	GPMU for Category I. RPMU for category II and for category III, services of environmental consultants will be availed by inviting tenders through SPMU / KRWSA.	Environmental appraisal and approval of proposed scheme of Category I or II or III is made using the checklist.
		To ensure that mitigation measures and their costs are integrated in scheme design and implementation plans.	Technical Approval for the scheme will not be accorded without Environmental Clearance from RPMU / SPMU.	Director Operations of KRWSA.	Technical approval for scheme with environmental mitigation measures and costs are integrated in scheme design and implementation plans.

Phase	EMF Activity	Objectives	Process	Responsibility	Result
<b>Implement- ation</b>	Implementation of schemes with due attention to environmental mitigation measures	To ensure that the prescribed environmental mitigation measures (including construction stage) are implemented.	Implementation Report (ICR) for scheme will need to include environmental measures (including construction stage) have been compiled with.	GPMU for Single GP schemes; GPE/ SE of RPMU for Multi GP schemes	ICR with environmental compliance information
<b>O&amp;M</b>	<ul style="list-style-type: none"> <li>•Environmental supervision, monitoring, and evaluation</li> <li>•IEC and capacity building on hygiene and environmental health issues</li> </ul>	To ensure that environmental aspects are integrated in the O&M phase.	Environmental Audit for water availability and water quality through external agency will be conducted once in a year by selecting 10 % of schemes completed. Water quality monitoring will be done by KWA twice a year.	Supervision will be done by Senior Engineer of RPMU at district level.  D (T) of KRWSA / SPMU at State level.	Water quality monitoring reports, periodic environmental supervision, monitoring and audit reports. Training and IEC activity reports.

**PUBLIC CONSULTATION  
ON  
DRAFT ENVIRONMENTAL ASSESSMENT AND PREPARATION OF ENVIRONMENTAL  
MANAGEMENT FRAMEWORK FOR JALANIDHI-2 PROJECT**

As a part of procedure for seeking the environmental clearance as per Bank's safe guard policies laid down in of World Bank guidelines, the project proponent i.e. KRWSA is required to conduct public consultation on the report so as to obtain views, suggestions and objections, if any, of the public on the proposed project.

KRWSA has taken following steps for public disclosure of the report:

1. The report will be displayed on the website to seek the public opinion / comments.
2. Report will be circulated to District Collector
3. Report will be circulated through listed NGOs.

Public Consultation was conducted on 14 June, 2011 at Institution of Engineers Building, Thiruvananthapuram.

At the meeting, there was overwhelming response from the public, beneficiaries and NGOs. The project benefits, Environmental issues, Environment management, Tribal Development Plan etc were the main aspects of the consultation. This was intended at updating the understanding of the villagers regarding the Rural water supply and sanitation project and soliciting there feedback on the proposed EMF.

Number of participants was around 50 and the proceedings of Public Consultation are enclosed as **Annexure 23**.

Query rose in the Public Consultation and the reply addressed in subsequent pages of the report are enclosed as **Annexure24**.



## Annexure 1 - Sanitation in Jalanidhi-2 (Strategy, Components and Process)

### STRATEGY

The challenges with regard to rural sanitation in Kerala in spite of the high level of sanitation coverage are:

- Emerging issues of solid and liquid waste management due to the urbanization of the rural areas, high density of population and the fast changing life style of the people.
- Coverage of the difficult groups and areas with household toilets i.e. high water table areas particularly in the coastal region, low lying areas like Kuttanad in Alappuzha District and tribal people living in forest areas and forest fringes.
- Coverage of landless people or those having very small holdings of land, especially those living in densely populated colonies and encroached land.
- Unsafe disposal of septage collected from the septic tanks of households and institutions by private operators, which is currently getting dumped mostly in water bodies.
- High level of bacteriological contamination of drinking water sources, due to poor sanitation.

Jalanidhi - 2 will address the above challenges adopting the following strategy in the GPs to be covered during the project period.

- Jalanidhi will draw upon the experience and expertise of Suchitwa Mission to implement the sanitation component of the project. KRWSA will enter in to an MOU with the Suchitwa Mission to collaborate and get the technical support in the planning and implementation of the program.
- Jalanidhi will try to cover the gaps in HH sanitation coverage in the project GPs, by undertaking complementary social mobilization, sanitation awareness and capacity building in collaboration with Kudumbasree, NRHM and ICDS programs. In the Jalanidhi-2 GPs, the GPAT/SO team will undertake an assessment of existing household sanitation and will identify households without toilets. They will then prepare a plan for addressing the issues using the TSC funds or Plan funds of the GP and /or the funds available under the sanitation component of Jalanidhi. In the case of tribal HHs in tribal projects (TDP), the project will provide subsidy of Rs. 3500 per HH for constructing twin pit pour flush toilets and GP will contribute Rs 1000/- per unit including labour through MNREGA
- Reaching the uncovered population living in difficult areas would require higher levels of investment since the construction is to be carried out in difficult terrain in case of tribal and fishermen colonies where the conventional models of single or twin shallow pit toilets are not suitable. Ecological sanitation (Eco-san) can be considered as a suitable alternative thinking for water scarce and high water table areas. Urine-diversion dehydration (UDD) toilets, composting toilets etc are some methods. Effective IEC activities need to be carried out to change the mindset of the people towards the new approach.

- The Suchitwa Mission has launched a pilot program in 225 GPs for Solid and Liquid Waste Management (SLWM) using the fund available under TSC for SLWM. Jalanidhi-2 will learn from this pilot and scale it up with suitable modification in the project GPs. The strategy to address the issues of solid waste is to (a) Promote community level management of bio-degradable waste through composting or bio gas technologies (b) Collection and processing of the market waste through composting or bio-methanation technologies by the GPs and (c) Non bio-degradable waste to be recycled at community level and reuse using appropriate technologies in a centralized manner.
- Regarding liquid waste, the strategy is to encourage community level decentralized waste water treatment systems in hot spots.
- Jalanidhi-2 will set up a Septage Treatment Plant (STP) for one district on a pilot basis during the project period in collaboration with LSGs. The STP will be operated by a private operator on payment basis collecting revenues from the service providers for collecting and treating the septage.

#### COMPONENTS

The following sanitation components are proposed for Jalanidhi - 2

- **Safe disposal of human excreta**
  - 1) Subsidy for construction of HH toilets for tribal people in 24 tribal projects (TDP)
  - 2) Piloting new technologies for latrine solutions in water logged /difficult areas.
  - 3) Pay and use latrine in appropriate locations (markets, tourist spots etc).
- **Safe disposal of solid waste**
  - 1) Community based vermin composting units /biogas units in hotspots
  - 2) Processing of the market waste through composting or bio-methanation technologies by the GPs.
  - 3) Implement processing units for Plastic (shredding units).
  - 4) Implement recycling units for plastics.
- **Safe disposal of liquid waste**
  - 1) Implement drainage interventions in critical sections of GPs with disposal systems to protect the water sources.
  - 2) Piloting of septage treatment facility in one District.
- **Capacity building for water safety (to be renamed)**
  - 1) Set up water quality testing facilities in the GPs to be based in higher secondary schools for ongoing testing of drinking water sources including domestic wells.

**DESCRIPTION OF EACH COMPONENT AND THE PROCESS INVOLVED****a) Safe disposal of human excreta**

Effective disposal of human excreta is an important parameter of sanitation since bacterial pollution of water bodies is ubiquitous in our state. Quite often indiscriminate excreta disposal results in to spread of water borne diseases in various parts of the state. In order to combat such situations and to create awareness among the people various components are proposed in the project for safe disposal of human excreta. A brief discussion in respect of each of such components is given below.

**1. Subsidy for construction of HH toilets for tribal people**

In the project, provision is made for providing subsidy for tribal households without toilets in 24 tribal projects (GPs) for the construction of HH toilets. The proposed amount of subsidy for each household is Rs 3500 and the number of tribal households without toilets in each GP is estimated to be around 100 and thus the total beneficiary HHs becomes 2400. The total cost for this program works out to Rs 21,600,000 (Rs.3500 x 2400). This subsidy will be paid from project funds. For implementing this program necessary IEC work will be carried out by the SO / GPAT team. An amount of RS 1000 per unit will be provided by GP including labour under MNREGA.

**2. Community Septic tanks in densely populated areas**

This program would include constructing community septic tank for a group of families in thickly populated areas where sufficient space is not available for individual facilities. Simple technology for construction of septic tank is to be followed. Land for constructing such type of septic tank is to be selected by the GP and the community benefitted from the septic tank is to be mobilized by the SO/GPAT. The unit consists of septic tank of appropriate capacity depending upon the users and an attached anaerobic digester for effluent with average retention period of two days. The purpose of the anaerobic digester is to get better treatment for the effluent to reduce pollution. In the project provision is given for 100 such units with an average cost for each unit at Rs. 200000. The total cost for this program comes to Rs. 20, 00,000. The cost will be shared between the project and GP in the ratio 80:20.

**3. Piloting latrine solutions for water logged and rocky terrains**

The project will address difficult situation for safe disposal of excreta in areas which are flooded for a considerable period of time in the year. In spite of prolonged research, no fool proof technology has been developed for safe disposal of excreta in such areas. But in the case of places where the flooding does not last for long and the height of water above the ground level is less various methods can be adopted. In this connection it is noteworthy that various organizations are seriously involved in research work to develop appropriate technology for safe disposal of wastes in water logged areas. At present the following options can be considered for implementation:

Eco-san toilet, sand shrouding, dewats, horizontal cylindrical latrines with raised embankments, common septic tank etc.

While implementing this program the technical wing of KRWSA will take the leadership and the Manager - Environment in the State PMU will be responsible for managing this program. For onsite support and supervision, the technical staff of SO/GPAT will be responsible and the social staff in the SO/GPAT will do the community mobilization /IEC work.

The cost of each unit is approximately Rs 50000 and the number of units proposed is 15 and thus the total cost becomes Rs 7, 50,000. Cost sharing for this item will be in the ratio 80:20 between project and GP. The cost of eco-san and sand shrouding are not considered for estimating as at present its acceptability is not confirmed.

**4. Pay and use latrine in appropriate locations (markets, tourist spots)**

The project will invest in constructing pay and use latrines in GPs where it is necessary due to floating population (migrants, tourists, markets etc). An appropriate location for establishing the unit will be selected by the GP and the operation and maintenance will be entrusted with Kudumbasree by the GP. The main component of the system is a septic tank, 2 no. of latrines and 3 no. of urinals. An amount of Rs 5 lakhs per unit is proposed for this program and the total cost comes to Rs. 750lakhs (Rs.5 lakhs x 150 GPs). Cost sharing for this program will be in the ratio 80:20 between project and GP.

**b) Safe Disposal of Solid Waste**

Safe disposal of solid waste is a major problem in Kerala in both urban and rural area. It is also pertinent that indiscriminate dumping of solid waste is resulting in pollution of water sources and unhygienic environment. Hence the project is planning to address the issue through community based solutions. The Suchitwa Mission has issued guidelines on specifications, standards, unit costs, O&M protocols, subsidy norms etc. for guiding the LSGs in preparation of SLWM projects. Jalanidhi - 2 will follow these guidelines.

**1. House hold level composting units- Vermi Composting unit**

Vermi composting is conversion of biodegradable solid waste into a usable fertilizer product by the action of earthworms. Under the community level vermi composting program, facilities for the composting of biodegradable solid waste into organic manure using worms will be set up. The compost has good demand and can be sold at a reasonable price. The requirement of this unit is, work shed, adequate number of tanks for composting the waste, appropriate worms, leachate collection system, cow dung, water storage tank etc. Size of the unit will be 1.5 kg/day waste feed. The cost of each unit is Rs 800 and 5000 units will be provided. A subsidy of Rs 400 will be met from the project.

**2. Household level anaerobic composting units-Ring Composting units**

It is proposed to setup 60000 units of capacity 1.5kg/day waste feed. The cost of each unit is Rs 1800/-. A subsidy of Rs 900 will be met from the project.

**3. Community level bio gas - Floating bio gas**

**Biogas** refers to gas produced by the biological breakdown of organic matter in the absence of oxygen. Biogas is produced by anaerobic digestion or

fermentation of biodegradable materials such as biomass, manure, sewage, municipal waste and plant material. This type of biogas comprises primarily methane and carbon dioxide. The gas produced can be used for cooking purpose or production of electricity. Jalanidhi – 2 will assist GPs to set up bio gas plants where the waste can be processed using this method. Units having treatment capacity varying from 100 kg to 500 kg of solid waste per day will be provided. It is estimated that the average cost of setting up one bio-gas unit is Rs 3.37 lakhs. The cost will depend on the size of the unit which will depend on the volume of the waste to be processed. It is proposed to set up 150 units in needy GPs in Jalanidhi - 2. The guidelines of the Suchitwa Mission will be adopted for the implementation of this program.

The total cost on this program is estimated to be Rs. 505.65 lakhs. The cost of construction should be shared by the project and the GP in the ratio 80:20.

KRWSA will empanel service providers to construct the above units and publish guidelines for implementation. The facility shall be owned by the GP and Kudumbasree will be engaged to operate it. The SO/GPAT team shall plan the implementation under the technical supervision of concerned RPMU staff

#### 4. Implementing processing units for plastic waste.

Excessive use of plastics and its indiscriminate disposal is a major challenge for waste management even in rural areas, especially where there are markets and urbanized areas. To address this problem, the project envisages implementation of community level plastic shredder units. The method involves segregating plastic from other wastes cleaning it and thereafter shredding and disposing it suitably. The shredded plastic can be sold to industries which are manufacturing plastic goods out of recycled plastic. It can also be used for other genuine purposes like using as an admixture with bitumen for roadwork.etc

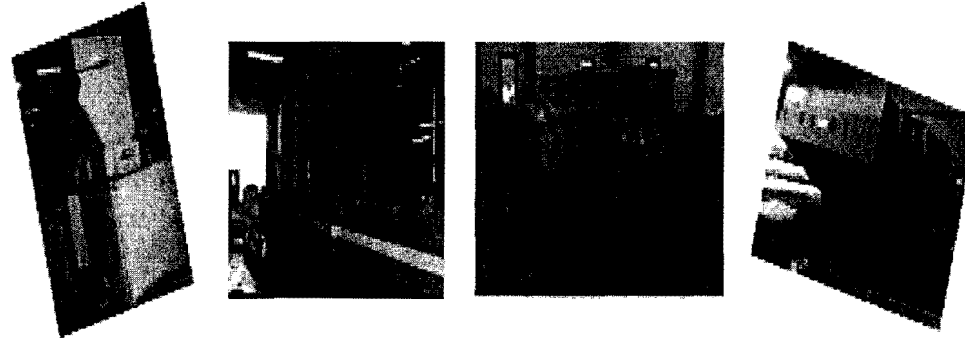

Figure 1 Plastic shredding unit for Various Establishments

- (a) Processing (recycling) units for inorganic waste. 5 units will be provided and the average cost per unit will be Rs 13 lakhs. Total cost will be Rs 65 lakhs. The cost of construction should be shared by the project and the GP in the ratio 80:20
- (b) Processing units (shredder): The cost of plastic shredder unit with 50 to 100kg/hour capacity with necessary shed for storage etc comes to Rs 5 lakhs. The total cost for 30nos of units comes to Rs 150 lakhs. The cost for implementation will be shared by the project and the GP in the ratio 80:20

KRWSA will empanel service providers to construct recycling units for inorganic wastes and publish guidelines for the implementation of this scheme. Facility shall be owned by GP and Kudumbasree or a private operator shall be engaged to operate it. The operating costs of the unit can be met from the revenue generated by selling the shredded plastic.

c) Safe disposal of waste water

*1. Implement drainage interventions and disposal systems in critical sections of GPs to protect the water sources*

In order to protect the water source from ingress of waste water, provision is given in the project for constructing drainage for diverting the waste water to far off distance from the water source and to dispose it through a soak pit etc. It is restricted that the length of drainage to be provided in a GP should not exceed 1 kilometer and the proposal is to divert waste water sources located within a distance of 250 meter from the water source of a particular scheme. A provision of Rs 10 lakhs is given for each GP and the total amount comes to Rs 1500 lakhs assuming that the scheme will be implemented in 150GPs. The cost will be shared in the ratio 80: 20 between the project and the GP.

*2. Piloting one septage treatment plant for collection, treatment, and disposal of septage collected from households & other establishments*

In the project provision is given for piloting one regional facility for collection, conveyance and treatment of septage from various households and other establishments. The intention behind implementation of this project is to prevent pollution of water bodies due to the current practice of indiscriminate dumping of septage by the private operators. The proposal is to implement one unit in a District with the cooperation of local Government. Land should be provided by the local bodies. The cost will be shared in the ratio 90: 10 between the project and the GP.

**Process involved**

The process involved in this sanitation component is to collect, transport, treat and safely dispose the septage. The septage from a septic tank contains septage water, sludge and other inorganic matter like napkins, plastic items, etc. In this connection it is noteworthy that most part of the excreta will be in an assimilated form and hence anaerobic digestion is not required. The septage water is to be treated in a treatment plant constructed based on the principle of activated sludge. The plant should have the following components : (a) Screening system for the removal of floating materials if any (b) Grit chamber for the removal of grit (c) Primary clarifier (d) Aeration tank (e) Secondary clarifier (f) Belt thickener (g) Anaerobic digester (h) Belt press (i) Chlorine contact tank and (j) Pump, pipes and other required accessories. A typical flow diagram of the activated sludge process is shown below.

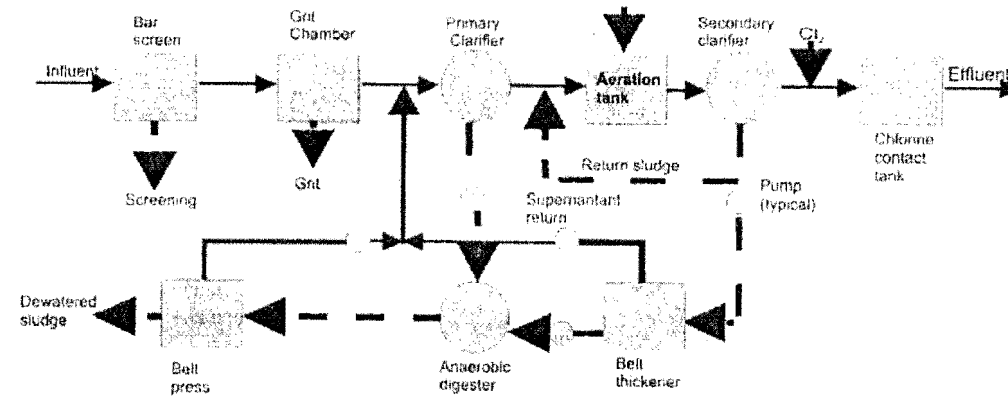

Physical, chemical and bacteriological treatments are performed in an activated sludge. The physical treatment processes are screening, grit removal, flow equalization, sedimentation, sludge thickening, filtration, etc. In chemical treatment the process involved are chemical precipitation, adsorption, disinfection etc. The biological treatment is facilitating the growth of appropriate bacteria and thereby the conversion of organic matter into settleable mass of bacteria and removing it by settling. In the plant the water is treated to the required effluent level and the sludge after necessary digestion should be moulded in cake forms and disposed off as manure. The inorganic matter will be disposed by cindering or by any other appropriate method.

The following assumptions are made for implementation of the scheme

- Excreta is removed from a septic tank usually once in eight years
- On an average one lakh litre of septage will be treated in a day
- Mostly septage collected from septic tanks will be treated
- Time required for one complete run of the treatment will be around 24 hours
- Tanker Lorries with pumping arrangements will be used for collection of septage
- On an average the plant will function for 300 days in an year

Considering the above mentioned assumptions septage collected from about 24000 nos of septic tanks should be available for running the project. The project is appropriate for Districts where at present excreta disposal is a serious matter of concern. The facility when developed will be a regional facility serving both the rural and urban population of a District with high rate of urbanization.

KRWSA will engage a consultant to conduct a needs assessment in selected Districts and prepare a detailed project report including the necessary institutional arrangements. The pilot District for implementing this project will be identified through the needs assessment and after negotiations with PRIs and ULBs in the District. Suchitwa Mission will be actively engaged in the identification and negotiations. The land required for putting up the plant will be acquired through local governments. The plant will be operated by a private operator selected through

a competitive bidding process. The estimated total cost of the facility is Rs 180 lakhs and it will be met from the project funds. However negotiations will be held for cost sharing by the beneficiary ULBs and PRIs.

The necessary institutional arrangement for managing the facility will be decided after a study of various options by the Consultant. The O&M of the facility will be vested with a private operator and it can be managed by the revenue generated.

#### **CAPACITY BUILDING FOR WATER SAFETY**

**1. *Setting up water quality testing facilities in the GPs to be based in higher secondary schools for ongoing testing of drinking water sources including domestic wells***

It is proposed to set up water quality testing laboratories in any of the selected higher secondary school in every GP where Jalanidhi - 2 is implemented. The purpose of such an establishment is to test water samples from the drinking water sources including domestic wells and to create awareness among the people about the quality of their drinking water and measures for protecting the sources. The laboratory will have the required equipments for the analysis of conventional water quality parameters. Necessary training for analyzing the various water quality parameters will be imparted to the teachers and students after establishment of the laboratory. Facilities will be provided for analysis of all the conventional physical, chemical and bacteriological parameters. A provision of Rs. 3lakhs is provided for establishing the laboratory in each GP. The total cost for this program is  $300 \times 4 =$  Rs 1200 lakhs. The total cost for the implementation of this programme will be met by the project. This program is prepared on the presumption that the school authorities will provide the necessary space for establishing the laboratory. The initial expenses for running the laboratory shall be met from the project funds. Thereafter the laboratory may raise the required maintenance expenses by contribution from the GPs as well as by collecting charges for testing the water quality from the users.

**IEC activities associated with the implementation of sanitation will be met from the IEC fund of KRWSA.**



**Annexure 2 - Protected Areas in Kerala**
**WILD LIFE SANCTUARIES**

S. No	Name of Reserve	Area in Km <sup>2</sup>	Year of Formation	District
1	Periyar Tiger Reserve	925.00	1950	Idukki
2	Neyyar Wildlife Sanctuary	128.00	1958	Thiruvananthapuram
3	Peechi - Vazhani Wildlife Sanctuary	125.00	1958	Thrissur
4	Parambikulam Wildlife Sanctuary (Tiger reserve)	285.00	1973	Palakkad
5	Wayanad Wildlife Sanctuary	344.44	1973	Wayanad
6	Idukki Wildlife Sanctuary	70.00	1976	Idukki
7	Peppara Wildlife Sanctuary	53.00	1983	Thiruvananthapuram
8	Thattekkad Bird Sanctuary	25.00	1983	Ernakulam
9	Shendurney Wildlife Sanctuary	171.00	1984	Kollam
10	Chinnar Wildlife Sanctuary	90.44	1984	Idukki
11	Chimmony Wildlife Sanctuary	85.00	1984	Thrissur
12	Aralam Wildlife Sanctuary	55.00	1984	Kannur
13	Mangalavanam Bird Sanctuary	0.027	2004	Ernakulam
14	Kurinjimala Sanctuary	32.00	2006	Idukki
15	Choolannur Pea Fowl Sanctuary	3.42	2007	Palakkad
16	Malabar Wildlife Sanctuary	74.215	2010	Kozhikode
17	Kottiyoor Wild life sanctuary	30.3798	2011	Kannur (Telichery)

**NATIONAL PARKS**

S. No	Name of Reserve	Area in Km <sup>2</sup>	Year of Formation	District
1	Eravikulam National Park	97.00	1978	Idukki
2	Silent Valley National Park	89.52	1984	Palakkad
3	Pampadum Shola National Park	1.318	2003	Idukki
4	Mathikettan Shola National Park	12.817	2003	Idukki
5	Anamudi Shola National Park	7.5	2003	Idukki

**BIOSPHERE RESERVES**

S. No	Name of Reserve	Area in Km <sup>2</sup>	Year of Formation
1	Agasthyavanam Biosphere Reserve	1,701.00	2002
2	Nilgiri Biosphere Reserve	1,455.40	1986



**COMMUNITY RESERVE**

S. No	Name of Reserve	Area in Km <sup>2</sup>	Year of Formation	District
1	Kadalundy Vallikunnu Community Reserve	1.5	2007	Kozhikkode & Malappuram

Source: [www.keralaforest.org](http://www.keralaforest.org)

**MANGROVE ECOSYSTEMS**

No.	Mangrove Area	District
1.	Chittari	Kasaragode
2.	Dharmadom	Kannur
3.	Nadakkavu	Kannur
4.	Edakkad	Kannur
5.	Valapattanam	Kannur
6.	Pappinisseri	Kannur
7.	Muzhapilangad	Kannur
8.	Kunhimangalam	Kannur
9.	Pazhayangadi	Kannur
10.	Kavvai	Kannur
11.	Thalassery	Kannur
12.	Ezhimala	Kannur
13.	Mahe	Kannur
14.	Kotti	Kozhikode
15.	Koduvalli	Kozhikode
16.	Badagara	Kozhikode
17.	Kallai	Kozhikode
18.	Kadalundi	Kozhikode/ Malappuram
19.	Tirur	Malappuram
20.	Chetwai	Thrissur
21.	Edappalli	Ernakulam
22.	Panangad/Kumbalam	Ernakulam
23.	Kannamali	Ernakulam
24.	Puthuvypin	Ernakulam
25.	Aroor	Alapuzha
26.	Kumarakom	Kottayam
27.	Asramom	Kollam
28.	Veli	Thiruvananthapuram

Source (SoE: 2007)

## Annexure 3 - District Wise Categorization of Blocks (March, 2004)

S. No.	Districts	Semi-critical		Critical		Over - exploited	
1	Thiruvananthapuram	1	Kilimanoor	1	Chirayinkil	1	Athiyannoor
		2	Nemom	2	Parassala	-	-
2	Quilon	1	Anchalamood	-	-	-	-
		2	Mukhathala				
		3	Pathanapuram				
		4	Vettikavala				
3	Idukki	1	Devikulam	1	Kattappana	-	-
		2	Nedumkandam				
4	Ernakulam	1	Alangadu	1	Angamaly	-	-
		2	Koovapady	2	Pampakuda		
		3	Mulanthuruthy	3	Parakadavu		
		4	Paravoor	4	Vyttila		
5	Thrissur	1	Mala	-	-	1	Kodungalloor
		2	Mathilakam				
		3	Ollurkara				
		4	Thalikulam				
6	Malappuram	1	Andathodu	1	Wandur		
		2	Kondotti				
		3	Kuttiapuram				
		4	Manjeri				
		5	Nilambur				
		6	Tanur				
		7	Tirurangadi				
		8	Vengara				
7	Palghat	1	Attapadi	1	Kollengode	1	Chittur
		2	Sreekrishnapuram	2	Palghat		
				3	Thrithala		
8	Kozhikode	1	Chevayoor	1	Balusseri	1	Kozhikode
				2	Tooneri		
9	Wayanad	1	Sulthan Bathery	-	-	-	-
10	Kannur	-	-	1	Kuthuparamba	-	-
				2	Tellisery		
11	Kasargod	1	Kanhangad	-	-	1	Kasargod
		2	Manjeshwar				

**ABSTRACT**

No. of Assessed Blocks	Semi - Critical	Critical	Over - exploited
151	30	15	5



**BLOCK-WISE CATEGORISATION AS ON 31<sup>st</sup> MARCH, 2004**
**DISTRICT: THIRUVANANTHAPURAM**

S. No	Assessment Unit/Block	Stage of Ground Water Development	Is there a significant decline of pre monsoon water table levels (Yes/No)	Is there a significant decline of post monsoon water table levels (Yes/No)	Categorization for future ground water development (Safe/Semi-critical/Critical / Over-exploited)
1	Varkala	80.76	Yes	No	Safe
2	Kilimanur	78.60	Yes	Yes	Semi critical
3	Vamanapuram	33.90	Yes	Yes	Safe
4	Chirayinkil	119.97	No	Yes	Critical
5	Kazhakuttam	84.22	No	No	Safe
6	Nedumangad	73.35	No	No	Safe
7	Vellanad	32.00	No	Yes	Safe
8	Thiruvananthapuram	75.37	No	No	Safe
9	Nemom	91.70	No	Yes	Semi critical
10	Perumkadavila	57.99	Yes	No	Safe
11	Athiyanoor	112.80	Yes	Yes	Over exploited
12	Parassala	106.90	No	No	Critical

**DISTRICT: KOLLAM**

S. No	Assessment Unit/Block	Stage of Ground Water Development	Is there a significant decline of pre monsoon water table levels (Yes/No)	Is there a significant decline of post monsoon water table levels (Yes/No)	Categorization for future ground water development (Safe/Semi-critical/Critical /Over-exploited)	Remarks
1	Sasthamkotta	63.96	No	Yes	Safe	
2	Karunagapalli	64.79	No	No	Safe	
3	Chavara	66.67	No	No	Safe	
4	Anchalumood	96.06	No	No	Semi critical	
5	Chittumala	61.08	Yes	No	Safe	
6	Vettikavala	87.74	No	Yes	Semi critical	
7	Pathanapuram	30.20	Yes	Yes	Semi critical	Sharp decline in water level



8	Anchal	11.70	Yes	Yes	Safe	
9	Kottarakara	66.72	Yes	No	Safe	
10	Mukhatala	91.46	Yes	No	Semi critical	
11	Ithikkara	56.17	Yes	Yes	Safe	
12	Chadayamangalam	56.11	Yes	Yes	Safe	
13	Oachira	75.95	No	No	Safe	

**DISTRICT: ALAPPUZHA**

S.No	Assessment Unit/Block	Stage of Ground Water Development	Is there a significant decline of pre monsoon water table levels (Yes/No)	Is there a significant decline of post monsoon water table levels (Yes/No)	Categorization for future ground water development (Safe/Semi-critical/Critical/Over-exploited)
1	Pattanakad	36.33	No	No	Safe
2	Thykattusseri	36.69	No	No	Safe
3	Kanjikuzhi	36.31	No	No	Safe
4	Aryad	59.20	No	No	Safe
5	Ambalapuzha	45.81	No	No	Safe
6	Champakulam	27.81	No	No	Safe
7	Veliyanad	18.97	No	No	Safe
8	Haripad	26.00	No	No	Safe
9	Chengannur	29.33	No	No	Safe
10	Mavelikara	25.21	No	No	Safe
11	Muthukulam	30.01	No	No	Safe
12	Bharnikavu	22.41	No	No	Safe

**DISTRICT: ERNAKULAM**

S. No	Assessment Unit/Block	Stage of Ground Water Development	Is there a significant decline of pre monsoon water table levels (Y/N)	Is there a significant decline of post monsoon water table levels (Y/N)	Categorization for future ground water development (Safe/Semi-critical/Critical/Over-exploited)	Remarks
1	Alangodu	72.99	Yes	Yes	Semi critical	
2	Angamali	60.46	Yes	Yes	Critical	
3	Edapalli	56.04	No	No	Safe	
4	Koovappadi	24.79	No	Yes	Semi critical	Sharp decline in water level



5	Kothamangalam	47.02	No	No	Safe	
6	Mulanthuruthy	87.76	Yes	Yes	Semi critical	
7	Moovattupuzha	47.69	No	Yes	Safe	
8	Palluruthy	62.14	No	No	Safe	
9	Pampakuda	79.84	Yes	Yes	Critical	
10	Parakadavu	99.81	No	Yes	Critical	
11	Paravur	91.83	No	Yes	Semi critical	
12	Vadavucode	24.63	Yes	No	Safe	
13	Vazhakulam	57.21	No	No	Safe	
14	Vypin	51.67	Yes	No	Safe	
15	Vyttila	57.14	Yes	Yes	Critical	Sharp decline in water level

**DISTRICT: THRISSUR**

Sl. No	Assessment Unit/Block	Stage of Ground Water Development	Is there a significant decline of pre monsoon water table levels (Yes/No)	Is there a significant decline of post monsoon water table levels (Yes/No)	Categorization for future ground water development (Safe/Semi critical/Critical/Over-exploited)	Remarks
1	Chavakkad	43.75	No	No	Safe	
2	Chowannur	39.28	No	No	Safe	
3	Vadakkancherry	67.10	No	No	Safe	
4	Pazhayannur	31.65	No	No	Safe	
5	Mullasserri	32.79	No	No	Safe	
6	Puzhakkal	26.03	No	No	Safe	
7	Ollurkara	39.90	Yes	Yes	Semi critical	Sharp decline in water level
8	Thalikulam	83.57	No	Yes	Semi critical	
9	Anthikkad	39.12	No	No	Safe	
10	Cherpu	23.82	No	No	Safe	
11	Kodakara	24.71	No	Yes	Safe	
12	Mathilakam	77.56	No	Yes	Semi critical	
13	Irinjalakuda	58.84	No	No	Safe	
14	Vellangallur	53.27	No	Yes	Safe	
15	Kodungallur	119.05	Yes	Yes	Overexploited	
16	Mala	91.08	No	Yes	Semi critical	
17	Chalakydy	44.68	No	Yes	Safe	

**DISTRICT: PALAKKAD**

S. No	Assessment Unit/Block	Stage of Ground Water Development	Is there a significant decline of pre monsoon water table levels (Yes/No)	Is there a significant decline of post monsoon water table levels (Yes/No)	Categorization for future ground water development (Safe/Semi-critical/Critical/Over-exploited)	Remarks
1	Kollengode	31.91	Yes	Yes	Critical	Sharp decline in water level
2	Nenmara	32.02	No	No	Safe	
3	Thritala	75.11	Yes	Yes	Critical	
4	Ottapalam	46.87	No	No	Safe	
5	Alathur	21.07	No	No	Safe	
6	Patambi	57.51	Yes	Yes	Safe	
7	Palakkad	42.40	No	Yes	Critical	
8	Attapadi	11.08	Yes	Yes	Semi critical	Sharp decline in water level
9	Kuzhalmannam	62.45	Yes	No	Safe	
10	Mannarghat	34.52	Yes	Yes	Safe	
11	Chittur	90.71	Yes	Yes	Over exploited	Sharp decline in water level
12	Sreekrishnapuram	37.96	Yes	Yes	Semi critical	Sharp decline in water level

**DISTRICT: MALAPPURAM**

S.No	Assessment Unit/Block	Stage of Ground Water Development	Is there a significant decline of pre monsoon water table levels (Yes/No)	Is there a significant decline of post monsoon water table levels (Yes/No)	Categorization for future ground water development (Safe/Semi critical/Critical/Over-exploited)	Remarks
1	Nilambur	39.96	Yes	Yes	Semi critical	Sharp decline in water level
2	Kondotty	62.03	Yes	Yes	Semi critical	Sharp decline in water level



3	Manjeri	72.65	No	Yes	Semi critical	
4	Wandur	40.07	Yes	Yes	Critical	Sharp decline in water level
5	Vengara	89.33	No	No	Semi critical	
6	Malappuram	56.22	No	No	Safe	
7	Mankada	61.84	No	Yes	Safe	
8	Perinthalmanna	38.38	No	No	Safe	
9	Tanur	94.21	No	Yes	Semi critical	
10	Tirur	69.12	No	Yes	Safe	
11	Kuttippuram	73.13	No	Yes	Semi critical	
12	Ponnani	67.38	No	No	Safe	
13	Andathodu	77.36	No	Yes	Semi critical	
14	Tirurangadi	74.22	No	No	Semi critical	

**DISTRICT: WAYANAD**

S. No	Assessment Unit/Block	Stage of Ground Water Development	Is there a significant decline of pre monsoon water table levels (Yes/No)	Is there a significant decline of post monsoon water table levels (Yes/No)	Categorization for future ground water development (Safe/Semi-critical/Critical/Over-exploited)	Remarks
1	Mananthawadi	28.38	No	No	Safe	
2	Kalpetta	20.88	No	No	Safe	
3	Sulthan Bathery	25.90	Yes	Yes	Semi critical	Sharp decline in water level

**DISTRICT: KOZHIKODE**

Sl. No	Assessment Unit/Block	Stage of Ground Water Development	Is there a significant decline of pre monsoon water table levels (Yes/No)	Is there a significant decline of post monsoon water table levels (Yes/No)	Categorization for future ground water development (Safe/Semi-critical / Critical /Over-exploited)
1	Badagara	50.31	Yes	Yes	Safe
2	Balusseri	123.87	Yes	Yes	Critical
3	Kozhikode	103.12	Yes	Yes	Over exploited
4	Chavayoor	86.78	Yes	Yes	Semi critical





5	Koduvally	58.60	Yes	Yes	Safe
6	Kunnummel	66.31	Yes	Yes	Safe
7	Kunnamangalam	67.32	No	No	Safe
8	Meladi	33.71	Yes	Yes	Safe
9	Panthalayani	26.45	No	No	Safe
10	Perambra	73.84	Yes	Yes	Safe
11	Thodannur	42.96	No	No	Safe
12	Tooneri	103.80	Yes	Yes	Critical

**DISTRICT: KASARGOD**

S.No	Assessment Unit/Block	Stage of Ground Water Development	Is there a significant decline of premonsoon water table levels (Yes/No)	Is there a significant decline of post monsoon water table levels (Yes/No)	Categorization for future ground water development (Safe/Semi-critical/Critical/Over-exploited)
1	Manjeshwar	70.65	Yes	Yes	Semi critical
2	Kasargod	123.59	Yes	Yes	Over exploited
3	Kanhangad	72.79	Yes	Yes	Semi critical
4	Nileshwar	63.23	Yes	No	Safe

Source: Dynamic Ground Water Resources of Kerala, Central Ground Water Board, 2004

## Annexure 4 - Specific Problems in Study Area

### I. THIRUVANANTHAPURAM DISTRICT

Field study was conducted at Kaliyoor GP (Nemon Block) and Kottukal GP (Athiyanoor Block).

#### Issues

- Major part of the Districts is underlain by the crystalline rocks. Sedimentary formations over lie the crystallines especially in the western part of the District.
- Coastal belt is mostly occupied by alluvial deposits of recent origin.
- Ground Water exploration in the deeper aquifers of hard rock area has indicated that yield varies from 1 to 7 lps, whereas in the sedimentary, the yield goes up to 10 lps.
- Yield of dug wells in the hard rock areas vary from 1 to 3 lps.
- In alluvial areas, yield of dug wells/ filter point wells varies from 2 to 5 lps. Net annual ground water availability is 278.03 MCM and the stage of ground water development is 66.82%.
- Out of 12 Blocks, 1 (Athiyanoor) has been categorized as over exploited, 2 as Critical, 2 as Semi critical and 7 Safe Blocks.

### II. KOLLAM DISTRICT

Estimation of groundwater resources in different Blocks of the District for the year 2004 has indicated that groundwater development in the District is around 45.82%. However four Blocks come under semi-critical category.

Thirukovilvattam GP, (Mukhathala Block) which comes under semi-critical zone, was selected for the EA study. The serious issue in the GP is iron contamination, over exploitation of groundwater from tube wells and fluoride problem in some areas.

During preliminary visit, samples were collected from wells and from Kaniyanthodu stream. The water samples contained iron. The main water source for the GP is Kaniyanthodu and the stream gets water from Kallada River. Solid waste dumping and the discharge of sewage into the stream have contaminated the water.

#### Issues

- Saline water ingress was observed in shallow alluvial aquifer in the western part of the District.
- Water logging is a general phenomenon along the regions bordering backwater lagoons during rainy season.
- The foothill regions of the Western Ghats falling in Pathanapuram and Anchal Blocks face acute water scarcity during summer.
- Chavara is polluted due to the effluent from the factory M/s. Kerala Metals and Minerals Ltd. The groundwater in the nearby area is highly acidic and contains certain trace elements like Zn, Mn and Fe.
- Paddy fields in the Ithikara are affected, Paravoor Kayal has become saline (fresh water laterite aquifer) due to sea water ingress.
- Ward no. 19 at Thirukovilvattam is located in Industrial area. Since the industries do not have proper ETP, effluent is discharged into nearby water bodies which in turn contaminate ground water.



### III. ALAPPUZHA DISTRICT

All the blocks come under safe category. Ramankary GP (Veliyanad Block) and Ezhupunna GP (Pattanakad Block) were selected for the EA study. Both the GPs are located in low land. From the results of water samples collected, it was found that organic contamination in Kongerithodu and Iron contamination in well water collected from Ezhupunna GP. Pesticide contamination is a serious issue in Ramankary GP. This is due to the usage of toxic pollutants for paddy cultivation by the farmers.

#### *Issues*

- There are many fish processing industries in and around Chandirur and Thiruvapur. The waste from the processing industries is directly discharged into the water bodies without treatment, which ultimately results in the contamination.
- Kuttanad has a very delicate ecosystem. Most of the Kuttanad areas lie in submerged condition during major part of the year. It is subjected to the twin hazards of flood discharge during monsoon and sea water ingress during summer.
- Certain tube wells tapping deeper confined aquifer around Alappuzha urban area, for drinking water supply registered excess fluoride concentration in the range of 1.7 to 2.56 mg/l.
- Shoreline erosion is one of the natural hazards affecting the District and extensive coastal erosion is taking place in the coastal areas of Thottappalli and Purakkad.

### IV. ERNAKULAM DISTRICT

Among 15 blocks, 4 blocks are found to be in critical zone. Pampakuda GP (Pampakuda Block) was selected for the EA study. This block is located in mid land area and comes under critical category. The water quality is fair. There are many ponds in this GP but most of them are contaminated due to the disposal of solid waste. Most of the dug wells dry up in summer.

#### *Issues*

- Even though the district receives very good rainfall of about 3400 mm annually acute water scarcity is felt in Vypin Island along the coastal area.
- Water scarcity is recorded all along the coastal parts of the District down to Chellanam.
- In the southern parts of the District, in the top layer of sand, the quality is brackish.
- In the midland areas of the District as in Mulanthuruthy, Pampakuda, Kothamangalam blocks, the dug wells dry up in summer.
- The District being industrial capital, pollution studies conducted by CGWB indicate that ground water pollution is highly localized within 80m of the dumping site of industrial waste.

### V. THRISSUR DISTRICT

Ollurkara, Thalikulam, Mathilakam and Mala Blocks of Thrissur District fall under semi critical zone and all other blocks are under safe category. The Kodungallur Block falls under over exploited category and already notified by central ground water Authority and State Ground Water Authority.



Eriyad GP (Mathilagam Block) was selected for EA study. This GP comes under coastal and over exploited zone. The water samples were collected from well and pond in Eriyad GP.

*Issues*

- Degradation in the quality of the ground water due to sea erosion.
- Acute water scarcity in the hilly areas in summer period due to drying up of dug wells and hand pumps. Dug wells in midland region dry up if monsoon is delayed or if there are no summer showers.
- The coastal areas stretching from Engandiyoor to Chettuva and the villages of Eriyad, Nattika and Chamakala experience severe sea erosion frequently leading to degrading ground water quality in nearby coastal aquifer.
- Kole land and adjoining areas are water logged for about six months in year and salinity increases from February to May.
- The water quality problems are highly localized which is found along the coastal area particularly during summer months.

**VI. PALAKKAD DISTRICT**

In Palakkad District, 2 Blocks fall in semi critical, 3 in critical and 1 under over exploited Category. Eruthenpathy GP (Chittur Block) and Agali GP (Attapadi Block) were selected for EA study. The Blocks are located in highland area close to the forest and come under over exploited zone. Sample was collected from well in Eruthenpathy GP and is found to contain Iron. TDS, Hardness, Alkalinity, Ca and Mg exceed the permissible limit.

*Issues*

- The quality of the groundwater in shallow aquifer is good. Certain pockets in the eastern parts are showing quality deterioration especially eastern part of Palaghat District where fluoride content is slightly high.
- The dug wells are showing fluoride in the range of 1 - 5.75 ppm. The higher values recorded from Kopanur and Chinnamoolathara. The water supply bore well of Eruthanpathy is also showing 1.76 ppm of fluoride.
- Inland salinity is noticed in Kadumthuruthi (Yakkara) and Kuduvayoor.
- Soft drinks manufacturing factory which was extracting groundwater for its products in the Chittur Block has invited agitation in a big way. The company is presently non operational.
- Factories operating in the industrial belt of Malampuzha Block are also extracting groundwater for its product.

**VII. MALAPURAM DISTRICT**

In general the District is devoid of any serious ground water related issues in terms of quantity and quality. However, the dug well in the lateritic aquifer goes dry immediately after the monsoon causing severe drinking water shortage to rural population.

Thirurangadi GP (Thirurangadi Block) was selected for the EA study. This GP was selected because of the location in low land area near to natural habitat (Bird sanctuary). This GP comes under semi-critical zone and contains iron problem.

*Issues*

- The chemical quality of the ground water in the District is generally good.
- The shallow groundwater from the alluvial formation has higher total dissolved solids and major ion constituents than that of other formation. This is due to the proximity of the pond water channels and tidal influence in the area occupied by coastal alluvium.
- Since the District is devoid of any major industries, ground water pollution is minimum.

**VIII. WAYANAD DISTRICT**

In this District, Sulthan Bathery Block, comes under semi-critical zone. Sulthan Bathery GP (Sulthan Bathery Block) was selected for EA study. This GP is located in low land close to the natural habitat (Bird Sanctuary) and comes under semi-critical zone. Well water sample collected, revealed that the parameters are within permissible limit.

*Issues*

- Decline in water level is observed at many places bordering Karnataka.
- Water scarcity is a severe problem during the drought period in the villages bordering Karnataka State. Mullenkolly, Pulpally, Tamitheruvu, Kappiset, Padichira and nearby areas come under rain shadow areas.
- Solid waste dumping is a severe problem. There is no proper solid waste management system.
- Shallow ground water in the vicinity of dumpsites is susceptible to contamination.

**IX. KOZHIKODE DISTRICT**

In Kozhikode District, Kozhikode Block comes under over-exploited category, Balusserri and Tooneri in critical; Chevayoor in semi-critical and the remaining blocks are in safe zone. Ramanattukara GP (Kozhikode Block) was selected for the EA study. The major issues identified with Ramanattukara GP were sea water intrusion in streams and poor solid waste management system.

*Issues*

- The quality of water from shallow and deep aquifers in the District is good for domestic and irrigation purposes. All the major chemical constituents including fluoride in the groundwater are within permissible limits and suitable for all purposes.
- The major problems noticed in the District are water scarcity, decline in water level and localized pollution etc.
- Water scarcity is a severe problem during drought in many Blocks especially those bordering Wayanad District namely Tooneri, Kunnummal, Perambra, Balusserri, Koduvalli and Kunnamangalam.
- Most of the tanks and ponds in the District are filled with silt and waste materials. The ponds are not recharging water into ground water system due to silt formation.
- The river water is exploited by constructing infiltration galleries to large wells and the galleries open to the river channel.
- Localised pollution is reported from many areas in the District, especially from effluent and sewage discharge from factories and hotels.

## X. KASARGOD DISTRICT

Kasargod Block comes under over exploited category, Manjeshwar and Kanhangad Blocks under semi critical and the Nileshwar Block falls under safe category. Enmakjae GP (Manjeswaram Block) and Kodumbelur GP (Kanhangad Block) were selected for the EA study. Enmakaje GP is located in coastal zone. Jalanidhi- 1 was implemented in this GP and there is Surangam for water harvesting.

Water samples were collected from wells in Swarga and Kanjampady in Enmakaje GP and from Chanakuzhi & Mupil in Kodumbelur GP. Pesticide contamination is found in Swarga stream. Samples taken in Enmakaje & Kodombelur contain high turbidity and iron is above the permissible limit and it requires treatment.

### *Pesticide contamination - Overview*

Kasaragod is famous for cashew plantation over a long period of 26 years. Aerial spraying of endosulfan on cashew sprayed over 4700 hectares resulted in the high incidence of central nervous system problems, psychiatric problems, nervous disorders, congenital problems and cancer. Endosulfan was found in the blood samples of the children in Kasargod.

The UNO classifies Endosulfan as highly dangerous insect killer and banned in 62 countries. Even though the Endosulfan is banned for more than 26 years, the usage of Endosulphan still continues.

As the plantations are mostly in mountainous areas, the pesticide drains and get washed down the slopes during rain into drinking water. Consuming this water will result in diseases ranging from physical deformities, cancers, birth disorders and damages to brain and nervous system. During 2000-2001 the victims got huge media introduction which resulted in Study of the victim's. The study of Endosulfan effects showed larger abnormality such as mental retardation, cancer and infertility.

India needs an effective chemical norm and should ratify a chemical & pesticide policy which would help people affected from chemical accidents & disasters; also stop usage of deadly pesticides for agriculture.

Affected places: Bellur village, Enmakaje Panchayat, Muliyar, Periy, Cheemeni, Pedre. Padre, Bovikanam, Rajapuram and Adhur.

Annexure 5 - Water Test Reports

TEST REPORT

<b>REPORT NO</b>	275	<b>DATE OF REPORT</b>	22-11-2010
<b>CUSTOMER NAME</b>	KRWSA, Kerala	<b>SAMPLE DESCRIPTION</b>	Drinking Water
<b>ADDRESS</b>	3 <sup>rd</sup> Floor, PTC Towers, S.S Kovil Road,Thampanoor Thiruvananthapuram-695001	<b>SAMPLE QUANTITY</b>	2 Ltrs
<b>REFERENCE NUMBER</b>	Ag.No. 11890 dt.4/8/2010	<b>SAMPLE RECEIVED ON</b>	18-11-2010
<b>SAMPLE COLLECTED BY</b>	ABC Environ Solutions Pvt.Ltd	<b>DATE OF ANALYSIS</b>	18-11-2010
<b>SAMPLING METHOD</b>	IS: 3025 Part 1 – 1987	<b>COMPLETED ON</b>	20-11-2010

S. NO	PARAMETER	UNIT	RESULTS		TEST PROCEDURE	Desirable Limit as per IS 10500 : 1991
			W1	W2		
1	Physical Appearance	-	Pale yellow with Turbid	Clear and Colourless	APHA 21 <sup>st</sup> EDI-2110	-
2	pH at 25°C	-	6.99	7.04	IS : 3025 Part 11- 1983 (Reaff: 2002)	6.5-8.5
3	Turbidity	NTU	75.2	BDL(<0.5)	IS : 3025 Part 10-1984 (Reaff: 2002)	5
4	Conductivity at 25°C	µS/cm	3140	180	IS : 3025 Part 14- 1984 (Reaff: 2002)	N.S.
5	Total dissolved solids	mg/l	1823	108	IS : 3025 Part 15-1984 (Reaff: 2003)	500
6	Total Alkalinity as CaCO <sub>3</sub>	mg/l	280	32	IS : 3025 Part 23- 1986(Reaff:2003)	200
7	Total Hardness as CaCO <sub>3</sub>	mg/l	508	40	IS : 3025 Part 21-1983 (Reaff: 1998)	300
8	Calcium as Ca	mg/l	104	11.4	IS : 3025 Part 40-1991 (Reaff:2003)	75
9	Magnesium as Mg	mg/l	61	2.9	APHA 21 <sup>st</sup> EDITION	30
10	Chloride as Cl <sup>-</sup>	mg/l	749	30	IS : 3025 Part 32-1988 (Reaff: 2003)	250
11	Sulphate as SO <sub>4</sub>	mg/l	151	1	APHA 21 <sup>st</sup> EDI-4500- SO <sub>4</sub> <sup>2-</sup> E	200
12	Sodium as Na	mg/l	455	16.8	IS : 3025 Part 45-1993 (Reaff:2003)	N.S.
13	Potassium as K	mg/l	32	5.6	IS : 3025 Part 45-1993 (Reaff:2003)	N.S.

Page 1 of 2

This test results relate only to the items tested. Unless otherwise state of the results shown in this test report only to the sample(s) tested and such sample (s) are retained for 7 days in case of Wastewater and 30 days for all other samples. The samples from regulatory bodies are to be retained as specified. This document cannot be reproduced except in full, without prior written approval of the company.



**TEST REPORT**

**REPORT NO** 275 **DATE OF REPORT** 22-11-2010  
**REFERENCE NUMBER** Ag.No. 11890 dt.4/8/2010 **SAMPLE DESCRIPTION** Drinking Water

14	Nitrate as NO <sub>3</sub>	mg/l	5.5	65	APHA 21 <sup>st</sup> EDI-4500- NO <sub>3</sub> <sup>-</sup> B	45
15	Fluoride as F	mg/l	0.76	BDL(<0.1)	APHA 21 <sup>st</sup> EDI-4500-F B&D	1.00
16	Iron as Fe	mg/l	BDL(<0.05)	2.19	IS : 3025 Part 53-2003	0.30
17	Ammonia as NH <sub>3</sub>	mg/l	BDL(<0.05)	BDL(<0.05)	APHA 21 <sup>st</sup> EDI-4500- NH <sub>3</sub> B&C	N.S.
18	Phosphate as PO <sub>4</sub>	mg/l	0.05	0.08	IS : 3025 Part 31-1988 (Reaff.2002)	N.S.
19	Chemical Oxygen Demand	mg/l	17	15	IS:3025:Part-58:2006	-
20	Total suspended solids	mg/l	BDL(<2)	21	IS : 3025 Part 17-1984 (Reaff: 2002)	-

....END OF REPORT....

BDL – Below Detection Limit

N.S. - Not Specified

W1 -Kottukal, Costal Area – Ward No: 9

W2 - Kottukal, Canal Water – Ward No 6 &7

Note

- Sample No (W1) contains more dissolved salts and also exceeds the limits of drinking water Specification IS 10500: 1991. It is recommended that alternate source for drinking water must be identified.
- Sample No (W2) contains high level of dissolved Iron which causes Turbidity. Treatment is required before Consumption.

for ABC ENVIRON SOLUTIONS PVT. LTD.,

AUTHORIZED SIGNATORY

Page 2 of 2

This test results relate only to the items tested. Unless otherwise state of the results shown in this test report only to the sample(s) tested and such sample (s) are retained for 7 days in case of Wastewater and 30 days for all other samples. The samples from regulatory bodies are to be retained as specified. This document cannot be reproduced except in full, without prior written approval of the company.





**TEST REPORT**

<b>REPORT NO</b>	294	<b>DATE OF REPORT</b>	03-12-2010
<b>CUSTOMER NAME</b>	KRWSA, Kerala	<b>SAMPLE DESCRIPTION</b>	Water
<b>ADDRESS</b>	3 <sup>rd</sup> Floor, PTC Towers, S.S Kovil Road, Thampanoor Thiruvananthapuram-695001	<b>SAMPLE QUANTITY</b>	2 Ltrs
<b>REFERENCE NUMBER</b>	Ag.No. 11890 dt.4/8/2010	<b>SAMPLE RECEIVED ON</b>	29-11-2010
<b>SAMPLE COLLECTED BY</b>	ABC Environ Solutions Pvt.Ltd.	<b>DATE OF ANALYSIS</b>	30-11-2010
<b>SAMPLING METHOD</b>	IS: 3025 Part 1 – 1987	<b>COMPLETED ON</b>	02-12-2010

S. NO	PARAMETER	UNIT	RESULTS		TEST PROCEDURE	Desirable Limit as per IS 10500 : 1991
			W1	W2		
1	Physical Appearance	-	Clear and Colourless	Pale Yellow	APHA 21 <sup>st</sup> EDI-2110	-
2	pH at 25°C	-	7.02	7.10	IS : 3025 Part 11- 1983 (Reaff: 2002)	6.5-8.5
3	Turbidity	NTU	BDL(<0.5)	2.1	IS : 3025 Part 10-1984 (Reaff: 2002)	5
4	Conductivity at 25°C	µS/cm	252	210	IS : 3025 Part 14- 1984 (Reaff: 2002)	N.S.
5	Total dissolved solids	mg/l	163	136	IS : 3025 Part 15-1984 (Reaff: 2003)	500
6	Total Alkalinity as CaCO <sub>3</sub>	mg/l	90	80	IS : 3025 Part 23- 1986(Reaff:2003)	200
7	Total Hardness as CaCO <sub>3</sub>	mg/l	100	76	IS : 3025 Part 21-1983 (Reaff: 1998)	300
8	Calcium as Ca	mg/l	36.8	25.6	IS : 3025 Part 40-1991 (Reaff:2003)	75
9	Magnesium as Mg	mg/l	1.9	2.9	APHA 21 <sup>st</sup> EDITION	30
10	Chloride as Cl <sup>-</sup>	mg/l	24	11	IS : 3025 Part 32-1988 (Reaff: 2003)	250
11	Sulphate as SO <sub>4</sub>	mg/l	9	2	APHA 21 <sup>st</sup> EDI-4500- SO <sub>4</sub> <sup>2-</sup> E	200
12	Sodium as Na	mg/l	8.1	9.7	IS : 3025 Part 45-1993 (Reaff:2003)	N.S.
13	Potassium as K	mg/l	5.5	5.9	IS : 3025 Part 45-1993 (Reaff:2003)	N.S.

Page 1 of 2

This test results relate only to the items tested. Unless otherwise state of the results shown in this test report only to the sample(s) tested and such sample (s) are retained for 7 days in case of Wastewater and 30 days for all other samples. The samples from regulatory bodies are to be retained as specified. This document cannot be reproduced except in full, without prior written approval of the company.



**TEST REPORT**

**REPORT NO** 294 **DATE OF REPORT** 03-12-2010  
**REFERENCE NUMBER** Ag.No. 11890 dt.4/8/2010 **SAMPLE DESCRIPTION** Water

14	Nitrate as NO <sub>3</sub>	mg/l	1.2	BDL(1)	APHA 21 <sup>st</sup> EDI-4500- NO <sub>3</sub> B	45
15	Fluoride as F	mg/l	BDL(<0.1)	BDL(<0.1)	APHA 21 <sup>st</sup> EDI-4500-F B&D	1.00
16	Iron as Fe	mg/l	0.1	BDL(<0.05)	IS : 3025 Part 53-2003	0.30
17	Ammonia as NH <sub>3</sub>	mg/l	0.12	0.15	APHA 21 <sup>st</sup> EDI-4500- NH <sub>3</sub> B&C	N.S.
18	Phosphate as PO <sub>4</sub>	mg/l	0.33	0.36	IS : 3025 Part 31-1988 (Reaff:2002)	N.S.
19	Total suspended solids	mg/l	BDL(<2)	4	IS : 3025 Part 17-1984 (Reaff: 2002)	-

....END OF REPORT....

BDL – Below Detection Limit

N.S. - Not Specified

W1 - Eriyad, Open Well.

W2 - Eriyad, Pond Water

for ABC ENVIRON SOLUTIONS PVT. LTD.,

AUTHORIZED SIGNATORY

Page 2 of 2

This test results relate only to the items tested. Unless otherwise state of the results shown in this test report only to the sample(s) tested and such sample (s) are retained for 7 days in case of Wastewater and 30 days for all other samples. The samples from regulatory bodies are to be retained as specified. This document cannot be reproduced except in full, without prior written approval of the company.



**TEST REPORT**

<b>REPORT NO</b>	291	<b>DATE OF REPORT</b>	29-11-2010
<b>CUSTOMER NAME</b>	KRWSA, Kerala	<b>SAMPLE DESCRIPTION</b>	Water
<b>ADDRESS</b>	3 <sup>rd</sup> Floor, PTC Towers, S.S Kovil Road, Thampanoor Thiruvananthapuram-695001	<b>SAMPLE QUANTITY</b>	2 Ltrs
<b>REFERENCE NUMBER</b>	Ag.No. 11890 dt.4/8/2010	<b>SAMPLE RECEIVED ON</b>	26-11-2010
<b>SAMPLE COLLECTED BY</b>	ABC Environ Solutions Pvt.Ltd.	<b>DATE OF ANALYSIS</b>	26-11-2010
<b>SAMPLING METHOD</b>	IS: 3025 Part 1 – 1987	<b>COMPLETED ON</b>	28-11 -2010

S. NO	PARAMETER	UNIT	RESULTS		TEST PROCEDURE	Desirable Limit as per IS 10500 : 1991
			W1	W2		
1	Physical Appearance	-	Pale Yellow	Pale Yellow	APHA 21 <sup>st</sup> EDI-2110	-
2	pH at 25°C	-	6.10	5.01	IS : 3025 Part 11- 1983 (Reaff: 2002)	6.5-8.5
3	Turbidity	NTU	5	1	IS : 3025 Part 10-1984 (Reaff: 2002)	5
4	Conductivity at 25°C	µS/cm	240	80	IS : 3025 Part 14- 1984 (Reaff: 2002)	N.S.
5	Total dissolved solids	mg/l	138	47	IS : 3025 Part 15-1984 (Reaff: 2003)	500
6	Total Alkalinity as CaCO <sub>3</sub>	mg/l	48	4	IS : 3025 Part 23- 1986(Reaff:2003)	200
7	Total Hardness as CaCO <sub>3</sub>	mg/l	52	8	IS : 3025 Part 21-1983 (Reaff: 1998)	300
8	Calcium as Ca	mg/l	15.2	1.6	IS : 3025 Part 40-1991 (Reaff:2003)	75
9	Magnesium as Mg	mg/l	3.4	1	APHA 21 <sup>st</sup> EDITION	30
10	Chloride as Cl <sup>-</sup>	mg/l	33	15	IS : 3025 Part 32-1988 (Reaff: 2003)	250
11	Sulphate as SO <sub>4</sub>	mg/l	8	BDL(<1)	APHA 21 <sup>st</sup> EDI-4500- SO <sub>4</sub> <sup>2-</sup> E	200
12	Sodium as Na	mg/l	24	12	IS : 3025 Part 45-1993 (Reaff:2003)	N.S.
13	Potassium as K	mg/l	3.8	BDL(<1)	IS : 3025 Part 45-1993 (Reaff:2003)	N.S.

Page 1 of 2

This test results relate only to the items tested. Unless otherwise state of the results shown in this test report only to the sample(s) tested and such sample (s) are retained for 7 days in case of Wastewater and 30 days for all other samples. The samples from regulatory bodies are to be retained as specified. This document cannot be reproduced except in full, without prior written approval of the company.



**TEST REPORT**

**REPORT NO** 291 **DATE OF REPORT** 29-11-2010  
**REFERENCE NUMBER** Ag.No. 11890 dt.4/8/2010 **SAMPLE DESCRIPTION** Water

14	Nitrate as NO <sub>3</sub>	mg/l	6.3	7.6	APHA 21 <sup>st</sup> EDI-4500- NO <sub>3</sub> <sup>-</sup> B	45
15	Fluoride as F	mg/l	BDL(<0.1)	BDL(<0.1)	APHA 21 <sup>st</sup> EDI-4500-F B&D	1.00
16	Iron as Fe	mg/l	0.52	0.07	IS : 3025 Part 53-2003	0.30
17	Ammonia as NH <sub>3</sub>	mg/l	0.10	0.06	APHA 21 <sup>st</sup> EDI-4500- NH <sub>3</sub> B&C	N.S.
18	Phosphate as PO <sub>4</sub>	mg/l	BDL(<0.01)	BDL(<0.01)	IS : 3025 Part 31-1988 (Reaff:2002)	N.S.
19	Total suspended solids	mg/l	2	6	IS : 3025 Part 17-1984 (Reaff: 2002)	-

....END OF REPORT....

BDL – Below Detection Limit

N.S. - Not Specified

W1 - Thirukovilvattam, Well Water (Kurumana).

W2 - Thirukovilvattam, Open Well Water (Mylapore, Near Industrial Locality)

Note: Sample No (W1) contains Iron above the permissible Limit, it requires Treatment.

Sample NoW2 Indicates that the sample is slightly acidic in nature.

for ABC ENVIRON SOLUTIONS PVT. LTD.,

AUTHORIZED SIGNATORY

Page 2 of 2

This test results relate only to the items tested. Unless otherwise state of the results shown in this test report only to the sample(s) tested and such sample (s) are retained for 7 days in case of Wastewater and 30 days for all other samples. The samples from regulatory bodies are to be retained as specified. This document cannot be reproduced except in full, without prior written approval of the company.



**TEST REPORT**

<b>REPORT NO</b>	292	<b>DATE OF REPORT</b>	29-11-2010
<b>CUSTOMER NAME</b>	KRWASA, Kerala	<b>SAMPLE DESCRIPTION</b>	Water
<b>ADDRESS</b>	3 <sup>rd</sup> Floor, PTC Towers, S.S Kovil Road, Thampanoor Thiruvananthapuram-695001	<b>SAMPLE QUANTITY</b>	2 Ltrs
<b>REFERENCE NUMBER</b>	Ag.No. 11890 dt.4/8/2010	<b>SAMPLE RECEIVED ON</b>	26-11-2010
<b>SAMPLE COLLECTED BY</b>	ABC Environ Solutions Pvt.Ltd.	<b>DATE OF ANALYSIS</b>	26-11-2010
<b>SAMPLING METHOD</b>	IS: 3025 Part 1 – 1987	<b>COMPLETED ON</b>	28-11 -2010

S.NO	PARAMETER	UNIT	RESULTS	TEST PROCEDURE	Desirable Limit as per IS 10500 : 1991
			W1		
1	Physical Appearance	-	Pale Yellow	APHA 21 <sup>st</sup> EDI-2110	-
2	pH at 25°C	-	6.57	IS : 3025 Part 11- 1983 (Reaff: 2002)	6.5-8.5
3	Turbidity	NTU	1.9	IS : 3025 Part 10-1984 (Reaff: 2002)	5
4	Conductivity at 25°C	µS/cm	98	IS : 3025 Part 14- 1984 (Reaff: 2002)	N.S.
5	Total dissolved solids	mg/l	56	IS : 3025 Part 15-1984 (Reaff: 2003)	500
6	Total Alkalinity as CaCO <sub>3</sub>	mg/l	16	IS : 3025 Part 23- 1986(Reaff:2003)	200
7	Total Hardness as CaCO <sub>3</sub>	mg/l	14	IS : 3025 Part 21-1983 (Reaff: 1998)	300
8	Calcium as Ca	mg/l	4	IS : 3025 Part 40-1991 (Reaff:2003)	75
9	Magnesium as Mg	mg/l	1	APHA 21 <sup>st</sup> EDITION	30
10	Chloride as Cl <sup>-</sup>	mg/l	15	IS : 3025 Part 32-1988 (Reaff: 2003)	250
11	Sulphate as SO <sub>4</sub>	mg/l	BDL(<1)	APHA 21 <sup>st</sup> EDI-4500- SO <sub>4</sub> <sup>2-</sup> E	200
12	Sodium as Na	mg/l	12.2	IS : 3025 Part 45-1993 (Reaff:2003)	N.S.
13	Potassium as K	mg/l	2.2	IS : 3025 Part 45-1993 (Reaff:2003)	N.S.

Page 1 of 2

This test results relate only to the items tested. Unless otherwise state of the results shown in this test report only to the sample(s) tested and such sample (s) are retained for 7 days in case of Wastewater and 30 days for all other samples. The samples from regulatory bodies are to be retained as specified. This document cannot be reproduced except in full, without prior written approval of the company.



**TEST REPORT**

**REPORT NO** 292 **DATE OF REPORT** 29-11-2010  
**REFERENCE NUMBER** Ag.No. 11890 dt.4/8/2010 **SAMPLE DESCRIPTION** Water

14	Nitrate as NO <sub>3</sub>	mg/l	BDL(<1)	APHA 21 <sup>st</sup> EDI-4500- NO <sub>3</sub> B	45
15	Fluoride as F	mg/l	BDL(<0.1)	APHA 21 <sup>st</sup> EDI-4500-F B&D	1.00
16	Iron as Fe	mg/l	0.37	IS : 3025 Part 53-2003	0.30
17	Ammonia as NH <sub>3</sub>	mg/l	0.22	APHA 21 <sup>st</sup> EDI-4500- NH <sub>3</sub> B&C	N.S.
18	Phosphate as PO <sub>4</sub>	mg/l	0.10	IS : 3025 Part 31-1988 (Reaff:2002)	N.S.
19	Total suspended solids	mg/l	4	IS : 3025 Part 17-1984 (Reaff: 2002)	-
20	Chemical Oxygen Demand	mg/l	8	IS:3025:Part-58:2006	-

....END OF REPORT....

BDL – Below Detection Limit

N.S. - Not Specified

W1 - Thirukovilvattam, Surface Water (Kaniyanthodu).

Note: Sample No (W1) contains Iron above the permissible Limit, it requires Treatment.

for ABC ENVIRON SOLUTIONS PVT. LTD.,

AUTHORIZED SIGNATORY

Page 2 of 2

This test results relate only to the items tested. Unless otherwise state of the results shown in this test report only to the sample(s) tested and such sample (s) are retained for 7 days in case of Wastewater and 30 days for all other samples. The samples from regulatory bodies are to be retained as specified. This document cannot be reproduced except in full, without prior written approval of the company.



**TEST REPORT**

<b>REPORT NO</b>	293	<b>DATE OF REPORT</b>	29-11-2010
<b>CUSTOMER NAME</b>	KRWSA, Kerala	<b>SAMPLE DESCRIPTION</b>	Water
<b>ADDRESS</b>	3 <sup>rd</sup> Floor, PTC Towers, S.S Kovil Road, Thampanoor Thiruvananthapuram-695001	<b>SAMPLE QUANTITY</b>	2 Ltrs
<b>REFERENCE NUMBER</b>	Ag.No. 11890 dt.4/8/2010	<b>SAMPLE RECEIVED ON</b>	26-11-2010
<b>SAMPLE COLLECTED BY</b>	ABC Environ Solutions Pvt.Ltd.	<b>DATE OF ANALYSIS</b>	26-11-2010
<b>SAMPLING METHOD</b>	IS: 3025 Part 1 – 1987	<b>COMPLETED ON</b>	28-11-2010

S.NO	PARAMETER	UNIT	RESULTS	TEST PROCEDURE	Desirable Limit as per IS 10500 : 1991
			W1		
1	Physical Appearance	-	Highly Turbid	APHA 21 <sup>st</sup> EDI-2110	-
2	pH at 25°C	-	6.74	IS : 3025 Part 11- 1983 (Reaff: 2002)	6.5-8.5
3	Turbidity	NTU	129	IS : 3025 Part 10-1984 (Reaff: 2002)	5
4	Conductivity at 25°C	µS/cm	115	IS : 3025 Part 14- 1984 (Reaff: 2002)	N.S.
5	Total dissolved solids	mg/l	78	IS : 3025 Part 15-1984 (Reaff: 2003)	500
6	Total Alkalinity as CaCO <sub>3</sub>	mg/l	32	IS : 3025 Part 23- 1986(Reaff:2003)	200
7	Total Hardness as CaCO <sub>3</sub>	mg/l	20	IS : 3025 Part 21-1983 (Reaff: 1998)	300
8	Calcium as Ca	mg/l	6.4	IS : 3025 Part 40-1991 (Reaff:2003)	75
9	Magnesium as Mg	mg/l	1	APHA 21 <sup>st</sup> EDITION	30
10	Chloride as Cl <sup>-</sup>	mg/l	12	IS : 3025 Part 32-1988 (Reaff: 2003)	250
11	Sulphate as SO <sub>4</sub>	mg/l	14	APHA 21 <sup>st</sup> EDI-4500- SO <sub>4</sub> <sup>2-</sup> E	200
12	Sodium as Na	mg/l	9.8	IS : 3025 Part 45-1993 (Reaff:2003)	N.S.
13	Potassium as K	mg/l	5.6	IS : 3025 Part 45-1993 (Reaff:2003)	N.S.

Page 1 of 2

This test results relate only to the items tested. Unless otherwise state of the results shown in this test report only to the sample(s) tested and such sample (s) are retained for 7 days in case of Wastewater and 30 days for all other samples. The samples from regulatory bodies are to be retained as specified. This document cannot be reproduced except in full, without prior written approval of the company.



**TEST REPORT**

**REPORT NO** 293 **DATE OF REPORT** 29-11-2010  
**REFERENCE NUMBER** Ag.No. 11890 dt.4/8/2010 **SAMPLE DESCRIPTION** Water

14	Nitrate as NO <sub>3</sub>	mg/l	8	APHA 21 <sup>st</sup> EDI-4500- NO <sub>3</sub> <sup>-</sup> B	45
15	Fluoride as F	mg/l	BDL(<0.1)	APHA 21 <sup>st</sup> EDI-4500-F B&D	1.00
16	Iron as Fe	mg/l	1.1	IS : 3025 Part 53-2003	0.30
17	Ammonia as NH <sub>3</sub>	mg/l	1.6	APHA 21 <sup>st</sup> EDI-4500- NH <sub>3</sub> B&C	N.S.
18	Phosphate as PO <sub>4</sub>	mg/l	0.24	IS : 3025 Part 31-1988 (Reaff:2002)	N.S.
19	Total suspended solids	mg/l	88	IS : 3025 Part 17-1984 (Reaff: 2002)	-
20	Chemical Oxygen Demand	mg/l	26.7	IS:3025:Part-58:2006	-

....END OF REPORT....

BDL – Below Detection Limit

N.S. - Not Specified

W1 - Kaliyoor, Vellayani Lake Water

Note : The Sample was highly turbid and colored also contains iron above the permissible limit.

COD Result indicates the organic contaminant in water.

for ABC ENVIRON SOLUTIONS PVT. LTD.,

AUTHORIZED SIGNATORY

Page 2 of 2

This test results relate only to the items tested. Unless otherwise state of the results shown in this test report only to the sample(s) tested and such sample (s) are retained for 7 days in case of Wastewater and 30 days for all other samples. The samples from regulatory bodies are to be retained as specified. This document cannot be reproduced except in full, without prior written approval of the company.





**TEST REPORT**

<b>REPORT NO</b>	295	<b>DATE OF REPORT</b>	06-12-2010
<b>CUSTOMER NAME</b>	KRWSA, Kerala	<b>SAMPLE DESCRIPTION</b>	Water
<b>ADDRESS</b>	3 <sup>rd</sup> Floor, PTC Towers, S.S Kovil Road, Thampanoor Thiruvananthapuram-695001	<b>SAMPLE QUANTITY</b>	2 Ltrs
<b>REFERENCE NUMBER</b>	Ag.No. 11890 dt.4/8/2010	<b>SAMPLE RECEIVED ON</b>	30-11-2010
<b>SAMPLE COLLECTED BY</b>	ABC Environ Solutions Pvt.Ltd.	<b>DATE OF ANALYSIS</b>	30-11-2010
<b>SAMPLING METHOD</b>	IS: 3025 Part 1 – 1987	<b>COMPLETED ON</b>	04-12 -2010

S. NO	PARAMETER	UNIT	RESULTS		TEST PROCEDURE	Desirable Limit as per IS 10500 : 1991
			W1	W2		
1	Physical Appearance	-	Pale Yellow	Pale Yellow	APHA 21 <sup>st</sup> EDI-2110	-
2	pH at 25°C	-	7.61	6.96	IS : 3025 Part 11- 1983 (Reaff: 2002)	6.5-8.5
3	Turbidity	NTU	2.5	1.3	IS : 3025 Part 10-1984 (Reaff: 2002)	5
4	Conductivity at 25°C	µS/cm	570	1775	IS : 3025 Part 14- 1984 (Reaff: 2002)	N.S.
5	Total dissolved solids	mg/l	317	1049	IS : 3025 Part 15-1984 (Reaff: 2003)	500
6	Total Alkalinity as CaCO <sub>3</sub>	mg/l	220	80	IS : 3025 Part 23-1986(Reaff:2003)	200
7	Total Hardness as CaCO <sub>3</sub>	mg/l	218	190	IS : 3025 Part 21-1983 (Reaff: 1998)	300
8	Calcium as Ca	mg/l	77	32	IS : 3025 Part 40-1991 (Reaff:2003)	75
9	Magnesium as Mg	mg/l	6.8	26.7	APHA 21 <sup>st</sup> EDITION	30
10	Chloride as Cl <sup>-</sup>	mg/l	38	501	IS : 3025 Part 32-1988 (Reaff: 2003)	250
11	Sulphate as SO <sub>4</sub>	mg/l	2	35	APHA 21 <sup>st</sup> EDI-4500- SO <sub>4</sub> <sup>2-</sup> E	200
12	Sodium as Na	mg/l	25	264	IS : 3025 Part 45-1993 (Reaff:2003)	N.S.
13	Potassium as K	mg/l	5.1	22	IS : 3025 Part 45-1993 (Reaff:2003)	N.S.

Page 1 of 2

This test results relate only to the items tested. Unless otherwise state of the results shown in this test report only to the sample(s) tested and such sample (s) are retained for 7 days in case of Wastewater and 30 days for all other samples. The samples from regulatory bodies are to be retained as specified. This document cannot be reproduced except in full, without prior written approval of the company.



**TEST REPORT**

**REPORT NO** 295 **DATE OF REPORT** 06-12-2010  
**REFERENCE NUMBER** Ag.No. 11890 dt.4/8/2010 **SAMPLE DESCRIPTION** Water

14	Nitrate as NO <sub>3</sub>	mg/l	3.4	2.0	APHA 21 <sup>st</sup> EDI-4500- NO <sub>3</sub> <sup>-</sup> B	45
15	Fluoride as F	mg/l	0.1	0.2	APHA 21 <sup>st</sup> EDI-4500-F B&D	1.00
16	Iron as Fe	mg/l	1.1	0.25	IS : 3025 Part 53-2003	0.30
17	Ammonia as NH <sub>3</sub>	mg/l	0.6	1.5	APHA 21 <sup>st</sup> EDI-4500- NH <sub>3</sub> B&C	N.S.
18	Phosphate as PO <sub>4</sub>	mg/l	0.54	1.1	IS : 3025 Part 31-1988 (Reaff:2002)	N.S.
19	Total suspended solids	mg/l	3	8	IS : 3025 Part 17-1984 (Reaff: 2002)	-
20	Chemical Oxygen Demand	mg/l	-	31	IS:3025:Part-58:2006	-

....END OF REPORT....

N.S. - Not Specified

W1 - Ezhupunna, Bore Well Water (Market).

W2 - Ezhupunna, Surface Water (Kongeri Thodu)

Note: Sample No (W1) contains Iron above the permissible Limit, it requires Treatment. Sample No: 2

COD Value Shows Minor Organic Pollution in the surface water.

for ABC ENVIRON SOLUTIONS PVT. LTD.,

AUTHORIZED SIGNATORY

**Page 2 of 2**

This test results relate only to the items tested. Unless otherwise state of the results shown in this test report only to the sample(s) tested and such sample (s) are retained for 7 days in case of Wastewater and 30 days for all other samples. The samples from regulatory bodies are to be retained as specified. This document cannot be reproduced except in full, without prior written approval of the company.



**TEST REPORT**

<b>REPORT NO</b>	296	<b>DATE OF REPORT</b>	06-12-2010
<b>CUSTOMER NAME</b>	KRWSA, Kerala	<b>SAMPLE DESCRIPTION</b>	Water
<b>ADDRESS</b>	3 <sup>rd</sup> Floor, PTC Towers, S.S Kovil Road, Thampanoor Thiruvananthapuram-695001	<b>SAMPLE QUANTITY</b>	2 Ltrs
<b>REFERENCE NUMBER</b>	Ag.No. 11890 dt.4/8/2010	<b>SAMPLE RECEIVED ON</b>	30-11-2010
<b>SAMPLE COLLECTED BY</b>	ABC Environ Solutions Pvt.Ltd.	<b>DATE OF ANALYSIS</b>	30-11-2010
<b>SAMPLING METHOD</b>	IS: 3025 Part 1 – 1987	<b>COMPLETED ON</b>	04-12 -2010

S.NO	PARAMETER	UNIT	RESULTS	TEST PROCEDURE	Desirable Limit as per IS 10500 : 1991
			W1		
1	Physical Appearance	-	Clear and Colourless	APHA 21 <sup>st</sup> EDI-2110	-
2	pH at 25°C	-	7.21	IS : 3025 Part 11- 1983 (Reaff: 2002)	6.5-8.5
3	Turbidity	NTU	BDL(<0.5)	IS : 3025 Part 10-1984 (Reaff: 2002)	5
4	Conductivity at 25°C	µS/cm	322	IS : 3025 Part 14- 1984 (Reaff: 2002)	N.S.
5	Total dissolved solids	mg/l	196	IS : 3025 Part 15-1984 (Reaff: 2003)	500
6	Total Alkalinity as CaCO <sub>3</sub>	mg/l	100	IS : 3025 Part 23- 1986(Reaff:2003)	200
7	Total Hardness as CaCO <sub>3</sub>	mg/l	96	IS : 3025 Part 21-1983 (Reaff: 1998)	300
8	Calcium as Ca	mg/l	28	IS : 3025 Part 40-1991 (Reaff:2003)	75
9	Magnesium as Mg	mg/l	6.3	APHA 21 <sup>st</sup> EDITION	30
10	Chloride as Cl <sup>-</sup>	mg/l	20	IS : 3025 Part 32-1988 (Reaff: 2003)	250
11	Sulphate as SO <sub>4</sub>	mg/l	18	APHA 21 <sup>st</sup> EDI-4500- SO <sub>4</sub> <sup>2-</sup> E	200
12	Sodium as Na	mg/l	24	IS : 3025 Part 45-1993 (Reaff:2003)	N.S.
13	Potassium as K	mg/l	4.5	IS : 3025 Part 45-1993 (Reaff:2003)	N.S.

Page 1 of 2

This test results relate only to the items tested. Unless otherwise state of the results shown in this test report only to the sample(s) tested and such sample (s) are retained for 7 days in case of Wastewater and 30 days for all other samples. The samples from regulatory bodies are to be retained as specified. This document cannot be reproduced except in full, without prior written approval of the company.



**TEST REPORT**

**REPORT NO** 296 **DATE OF REPORT** 06-12-2010  
**REFERENCE NUMBER** Ag.No. 11890 dt.4/8/2010 **SAMPLE DESCRIPTION** Water

14	Nitrate as NO <sub>3</sub>	mg/l	BDL(<1)	APHA 21 <sup>st</sup> EDI-4500- NO <sub>3</sub> <sup>-</sup> B	45
15	Fluoride as F	mg/l	0.23	APHA 21 <sup>st</sup> EDI-4500-F B&D	1.00
16	Iron as Fe	mg/l	0.19	IS : 3025 Part 53-2003	0.30
17	Ammonia as NH <sub>3</sub>	mg/l	0.08	APHA 21 <sup>st</sup> EDI-4500- NH <sub>3</sub> B&C	N.S.
18	Phosphate as PO <sub>4</sub>	mg/l	1.0	IS : 3025 Part 31-1988 (Reaff:2002)	N.S.
19	Total suspended solids	mg/l	BDL(<2)	IS : 3025 Part 17-1984 (Reaff: 2002)	-

....END OF REPORT....

BDL – Below Detection Limit

N.S. - Not Specified

W1 - Ramankary, Well Water.

for ABC ENVIRON SOLUTIONS PVT. LTD.,

AUTHORIZED SIGNATORY

Page 2 of 2

This test results relate only to the items tested. Unless otherwise state of the results shown in this test report only to the sample(s) tested and such sample (s) are retained for 7 days in case of Wastewater and 30 days for all other samples. The samples from regulatory bodies are to be retained as specified. This document cannot be reproduced except in full, without prior written approval of the company.



**TEST REPORT**

<b>REPORT NO</b>	297	<b>DATE OF REPORT</b>	08-12-2010
<b>CUSTOMER NAME</b>	KRWSA, Kerala	<b>SAMPLE DESCRIPTION</b>	Water
<b>ADDRESS</b>	3 <sup>rd</sup> Floor, PTC Towers, S.S Kovil Road, Thampanoor Thiruvananthapuram-695001	<b>SAMPLE QUANTITY</b>	2 Ltrs
<b>REFERENCE NUMBER</b>	Ag.No. 11890 dt.4/8/2010	<b>SAMPLE RECEIVED ON</b>	02-12-2010
<b>SAMPLE COLLECTED BY</b>	ABC Environ Solutions Pvt.Ltd.	<b>DATE OF ANALYSIS</b>	02-12-2010
<b>SAMPLING METHOD</b>	IS: 3025 Part 1 – 1987	<b>COMPLETED ON</b>	06-12 -2010

S.NO	PARAMETER	UNIT	RESULTS	TEST PROCEDURE	Desirable Limit as per IS 10500 : 1991
			W1		
1	Physical Appearance	-	Pale Yellow	APHA 21 <sup>st</sup> EDI-2110	-
2	pH at 25°C	-	6.70	IS : 3025 Part 11- 1983 (Reaff: 2002)	6.5-8.5
3	Turbidity	NTU	2.6	IS : 3025 Part 10-1984 (Reaff: 2002)	5
4	Conductivity at 25°C	µS/cm	560	IS : 3025 Part 14- 1984 (Reaff: 2002)	N.S.
5	Total dissolved solids	mg/l	297	IS : 3025 Part 15-1984 (Reaff: 2003)	500
6	Total Alkalinity as CaCO <sub>3</sub>	mg/l	130	IS : 3025 Part 23- 1986(Reaff:2003)	200
7	Total Hardness as CaCO <sub>3</sub>	mg/l	106	IS : 3025 Part 21-1983 (Reaff: 1998)	300
8	Calcium as Ca	mg/l	36	IS : 3025 Part 40-1991 (Reaff:2003)	75
9	Magnesium as Mg	mg/l	3.8	APHA 21 <sup>st</sup> EDITION	30
10	Chloride as Cl <sup>-</sup>	mg/l	75	IS : 3025 Part 32-1988 (Reaff: 2003)	250
11	Sulphate as SO <sub>4</sub>	mg/l	24	APHA 21 <sup>st</sup> EDI-4500- SO <sub>4</sub> <sup>2-</sup> E	200
12	Sodium as Na	mg/l	65	IS : 3025 Part 45-1993 (Reaff:2003)	N.S.
13	Potassium as K	mg/l	12	IS : 3025 Part 45-1993 (Reaff:2003)	N.S.

Page 1 of 2

This test results relate only to the items tested. Unless otherwise state of the results shown in this test report only to the sample(s) tested and such sample (s) are retained for 7 days in case of Wastewater and 30 days for all other samples. The samples from regulatory bodies are to be retained as specified. This document cannot be reproduced except in full, without prior written approval of the company.



**TEST REPORT**

**REPORT NO** 297 **DATE OF REPORT** 08-12-2010  
**REFERENCE NUMBER** Ag.No. 11890 dt.4/8/2010 **SAMPLE DESCRIPTION** Water

14	Nitrate as NO <sub>3</sub>	mg/l	BDL(<1)	APHA 21 <sup>st</sup> EDI-4500- NO <sub>3</sub> <sup>-</sup> B	45
15	Fluoride as F	mg/l	0.25	APHA 21 <sup>st</sup> EDI-4500-F B&D	1.00
16	Iron as Fe	mg/l	0.44	IS : 3025 Part 53-2003	0.30
17	Ammonia as NH <sub>3</sub>	mg/l	1.1	APHA 21 <sup>st</sup> EDI-4500- NH <sub>3</sub> B&C	N.S.
18	Phosphate as PO <sub>4</sub>	mg/l	0.04	IS : 3025 Part 31-1988 (Reaff:2002)	N.S.
19	Total suspended solids	mg/l	11	IS : 3025 Part 17-1984 (Reaff: 2002)	-

....END OF REPORT....

BDL – Below Detection Limit

N.S. - Not Specified

W1 - Aanithara, Well Water. (Ward No: 23)

Note: Sample No (W1) contains Iron above the permissible Limit, it requires Treatment.

For ABC ENVIRON SOLUTIONS PVT. LTD.,

AUTHORIZED SIGNATORY

Page 2 of 2

This test results relate only to the items tested. Unless otherwise state of the results shown in this test report only to the sample(s) tested and such sample (s) are retained for 7 days in case of Wastewater and 30 days for all other samples. The samples from regulatory bodies are to be retained as specified. This document cannot be reproduced except in full, without prior written approval of the company.



**TEST REPORT**

<b>REPORT NO</b>	298	<b>DATE OF REPORT</b>	08-12-2010
<b>CUSTOMER NAME</b>	KRWSA, Kerala	<b>SAMPLE DESCRIPTION</b>	Water
<b>ADDRESS</b>	3 <sup>rd</sup> Floor, PTC Towers, S.S Kovil Road, Thampanoor Thiruvananthapuram-695001	<b>SAMPLE QUANTITY</b>	2 Ltrs
<b>REFERENCE NUMBER</b>	Ag.No. 11890 dt.4/8/2010	<b>SAMPLE RECEIVED ON</b>	02-12-2010
<b>SAMPLE COLLECTED BY</b>	ABC Environ Solutions Pvt.Ltd.	<b>DATE OF ANALYSIS</b>	02-12-2010
<b>SAMPLING METHOD</b>	IS: 3025 Part 1 – 1987	<b>COMPLETED ON</b>	06-12 -2010

S.N O	PARAMETER	UNIT	RESULTS		TEST PROCEDURE	Desirable Limit as per IS 10500 : 1991
			W1	W2		
1	Physical Appearance	-	Pale Yellow	Pale Yellow	APHA 21 <sup>st</sup> EDI-2110	-
2	pH at 25°C	-	6.30	6.88	IS : 3025 Part 11- 1983 (Reaff: 2002)	6.5-8.5
3	Turbidity	NTU	5.4	2.2	IS : 3025 Part 10-1984 (Reaff: 2002)	5
4	Conductivity at 25°C	µS/cm	96	65	IS : 3025 Part 14- 1984 (Reaff: 2002)	N.S.
5	Total dissolved solids	mg/l	59	38	IS : 3025 Part 15-1984 (Reaff: 2003)	500
6	Total Alkalinity as CaCO <sub>3</sub>	mg/l	18	16	IS : 3025 Part 23-1986(Reaff:2003)	200
7	Total Hardness as CaCO <sub>3</sub>	mg/l	22	16	IS : 3025 Part 21-1983 (Reaff: 1998)	300
8	Calcium as Ca	mg/l	8	4	IS : 3025 Part 40-1991 (Reaff:2003)	75
9	Magnesium as Mg	mg/l	BDL(<1)	1.4	APHA 21 <sup>st</sup> EDITION	30
10	Chloride as Cl <sup>-</sup>	mg/l	15	8	IS : 3025 Part 32-1988 (Reaff: 2003)	250
11	Sulphate as SO <sub>4</sub>	mg/l	BDL(<1)	BDL(<1)	APHA 21 <sup>st</sup> EDI-4500- SO <sub>4</sub> <sup>2-</sup> E	200
12	Sodium as Na	mg/l	8.7	5.5	IS : 3025 Part 45-1993 (Reaff:2003)	N.S.
13	Potassium as K	mg/l	BDL(<1)	1	IS : 3025 Part 45-1993 (Reaff:2003)	N.S.

Page 1 of 2

This test results relate only to the items tested. Unless otherwise state of the results shown in this test report only to the sample(s) tested and such sample (s) are retained for 7 days in case of Wastewater and 30 days for all other samples. The samples from regulatory bodies are to be retained as specified. This document cannot be reproduced except in full, without prior written approval of the company.



**TEST REPORT**

**REPORT NO** 298 **DATE OF REPORT** 08-12-2010  
**REFERENCE NUMBER** Ag.No. 11890 dt.4/8/2010 **SAMPLE DESCRIPTION** Water

14	Nitrate as NO <sub>3</sub>	mg/l	BDL(<1)	1.4	APHA 21 <sup>st</sup> EDI-4500- NO <sub>3</sub> <sup>-</sup> B	45
15	Fluoride as F	mg/l	BDL(<0.1)	BDL(<0.1)	APHA 21 <sup>st</sup> EDI-4500-F B&D	1.00
16	Iron as Fe	mg/l	1.98	0.24	IS : 3025 Part 53-2003	0.30
17	Ammonia as NH <sub>3</sub>	mg/l	0.33	0.26	APHA 21 <sup>st</sup> EDI-4500- NH <sub>3</sub> B&C	N.S.
18	Phosphate as PO <sub>4</sub>	mg/l	BDL(<0.01)	BDL(<0.01)	IS : 3025 Part 31-1988 (Reaff:2002)	N.S.
19	Total suspended solids	mg/l	4	6	IS : 3025 Part 17-1984 (Reaff: 2002)	-

....END OF REPORT....

BDL – Below Detection Limit

N.S. - Not Specified

W1 - Janakiya Panchayat Well Water (Ward No: 32).

W2 - Kadalundi River Water

Note: Sample No (W1) contains high amount dissolved Iron, which imparts Colour and Turbid.

for ABC ENVIRON SOLUTIONS PVT. LTD.,

AUTHORIZED SIGNATORY

Page 2 of 2

This test results relate only to the items tested. Unless otherwise state of the results shown in this test report only to the sample(s) tested and such sample (s) are retained for 7 days in case of Wastewater and 30 days for all other samples. The samples from regulatory bodies are to be retained as specified. This document cannot be reproduced except in full, without prior written approval of the company.





**TEST REPORT**

<b>REPORT NO</b>	299	<b>DATE OF REPORT</b>	14-12-2010
<b>CUSTOMER NAME</b>	KRWSA, Kerala	<b>SAMPLE DESCRIPTION</b>	Water
<b>ADDRESS</b>	3 <sup>rd</sup> Floor, PTC Towers, S.S Kovil Road, Thampanoor Thiruvananthapuram-695001	<b>SAMPLE QUANTITY</b>	2 Ltrs
<b>REFERENCE NUMBER</b>	Ag.No. 11890 dt.4/8/2010	<b>SAMPLE RECEIVED ON</b>	09-12-2010
<b>SAMPLE COLLECTED BY</b>	ABC Environ Solutions Pvt.Ltd.	<b>DATE OF ANALYSIS</b>	09-12-2010
<b>SAMPLING METHOD</b>	IS: 3025 Part 1 – 1987	<b>COMPLETED ON</b>	13-12 -2010

S.NO	PARAMETER	UNIT	RESULTS	TEST PROCEDURE	Desirable Limit as per IS 10500 : 1991
			W1		
1	Physical Appearance	-	Clear & Colourless	APHA 21 <sup>st</sup> EDI-2110	-
2	pH at 25°C	-	6.83	IS : 3025 Part 11- 1983 (Reaff: 2002)	6.5-8.5
3	Turbidity	NTU	BDL(<0.5)	IS : 3025 Part 10-1984 (Reaff: 2002)	5
4	Conductivity at 25°C	µS/cm	238	IS : 3025 Part 14- 1984 (Reaff: 2002)	N.S.
5	Total dissolved solids	mg/l	154	IS : 3025 Part 15-1984 (Reaff: 2003)	500
6	Total Alkalinity as CaCO <sub>3</sub>	mg/l	96	IS : 3025 Part 23- 1986(Reaff:2003)	200
7	Total Hardness as CaCO <sub>3</sub>	mg/l	83.7	IS : 3025 Part 21-1983 (Reaff: 1998)	300
8	Calcium as Ca	mg/l	28.7	IS : 3025 Part 40-1991 (Reaff:2003)	75
9	Magnesium as Mg	mg/l	2.9	APHA 21 <sup>st</sup> EDITION	30
10	Chloride as Cl <sup>-</sup>	mg/l	23.8	IS : 3025 Part 32-1988 (Reaff: 2003)	250
11	Sulphate as SO <sub>4</sub>	mg/l	BDL(<1)	APHA 21 <sup>st</sup> EDI-4500- SO <sub>4</sub> <sup>2-</sup> E	200
12	Sodium as Na	mg/l	12.8	IS : 3025 Part 45-1993 (Reaff:2003)	N.S.
13	Potassium as K	mg/l	4.2	IS : 3025 Part 45-1993 (Reaff:2003)	N.S.

Page 1 of 2

This test results relate only to the items tested. Unless otherwise state of the results shown in this test report only to the sample(s) tested and such sample (s) are retained for 7 days in case of Wastewater and 30 days for all other samples. The samples from regulatory bodies are to be retained as specified. This document cannot be reproduced except in full, without prior written approval of the company.



**TEST REPORT**

**REPORT NO** 299 **DATE OF REPORT** 14-12-2010  
**REFERENCE NUMBER** Ag.No. 11890 dt.4/8/2010 **SAMPLE DESCRIPTION** Water

14	Nitrate as NO <sub>3</sub>	mg/l	1.6	APHA 21 <sup>st</sup> EDI-4500- NO <sub>3</sub> <sup>-</sup> B	45
15	Fluoride as F	mg/l	0.18	APHA 21 <sup>st</sup> EDI-4500-F B&D	1.00
16	Iron as Fe	mg/l	0.13	IS : 3025 Part 53-2003	0.30
17	Ammonia as NH <sub>3</sub>	mg/l	0.29	APHA 21 <sup>st</sup> EDI-4500- NH <sub>3</sub> B&C	N.S.
18	Phosphate as PO <sub>4</sub>	mg/l	0.02	IS : 3025 Part 31-1988 (Reaff:2002)	N.S.

....END OF REPORT....

BDL – Below Detection Limit

N.S. - Not Specified

W1 - Sultan Bathery GP, Jawahar Colony, Well Water. (Ward No: 08)

for ABC ENVIRON SOLUTIONS PVT. LTD.,

AUTHORIZED SIGNATORY

Page 2 of 2

This test results relate only to the items tested. Unless otherwise state of the results shown in this test report only to the sample(s) tested and such sample (s) are retained for 7 days in case of Wastewater and 30 days for all other samples. The samples from regulatory bodies are to be retained as specified. This document cannot be reproduced except in full, without prior written approval of the company.



**TEST REPORT**

<b>REPORT NO</b>	300	<b>DATE OF REPORT</b>	14-12-2010
<b>CUSTOMER NAME</b>	KRWSA, Kerala	<b>SAMPLE DESCRIPTION</b>	Water
<b>ADDRESS</b>	3 <sup>rd</sup> Floor, PTC Towers, S.S Kovil Road, Thampanoor Thiruvananthapuram-695001	<b>SAMPLE QUANTITY</b>	2 Ltrs
<b>REFERENCE NUMBER</b>	Ag.No. 11890 dt.4/8/2010	<b>SAMPLE RECEIVED ON</b>	09-12-2010
<b>SAMPLE COLLECTED BY</b>	ABC Environ Solutions Pvt.Ltd.	<b>DATE OF ANALYSIS</b>	09-12-2010
<b>SAMPLING METHOD</b>	IS: 3025 Part 1 – 1987	<b>COMPLETED ON</b>	13-12 -2010

S.NO	PARAMETER	UNIT	RESULTS	TEST PROCEDURE	Desirable Limit as per IS 10500 : 1991
			W1		
1	Physical Appearance	-	Pale Yellow	APHA 21 <sup>st</sup> EDI-2110	-
2	pH at 25°C	-	6.28	IS : 3025 Part 11- 1983 (Reaff: 2002)	6.5-8.5
3	Turbidity	NTU	7.6	IS : 3025 Part 10-1984 (Reaff: 2002)	5
4	Conductivity at 25°C	µS/cm	143	IS : 3025 Part 14- 1984 (Reaff: 2002)	N.S.
5	Total dissolved solids	mg/l	82	IS : 3025 Part 15-1984 (Reaff: 2003)	500
6	Total Alkalinity as CaCO <sub>3</sub>	mg/l	52	IS : 3025 Part 23- 1986(Reaff:2003)	200
7	Total Hardness as CaCO <sub>3</sub>	mg/l	49.8	IS : 3025 Part 21-1983 (Reaff: 1998)	300
8	Calcium as Ca	mg/l	11.2	IS : 3025 Part 40-1991 (Reaff:2003)	75
9	Magnesium as Mg	mg/l	5.3	APHA 21 <sup>st</sup> EDITION	30
10	Chloride as Cl <sup>-</sup>	mg/l	8.9	IS : 3025 Part 32-1988 (Reaff: 2003)	250
11	Sulphate as SO <sub>4</sub>	mg/l	BDL(<1)	APHA 21 <sup>st</sup> EDI-4500- SO <sub>4</sub> <sup>2-</sup> E	200
12	Sodium as Na	mg/l	8	IS : 3025 Part 45-1993 (Reaff:2003)	N.S.
13	Potassium as K	mg/l	2.3	IS : 3025 Part 45-1993 (Reaff:2003)	N.S.

Page 1 of 2

This test results relate only to the items tested. Unless otherwise state of the results shown in this test report only to the sample(s) tested and such sample (s) are retained for 7 days in case of Wastewater and 30 days for all other samples. The samples from regulatory bodies are to be retained as specified. This document cannot be reproduced except in full, without prior written approval of the company.



**TEST REPORT**

**REPORT NO** 300 **DATE OF REPORT** 14-12-2010  
**REFERENCE NUMBER** Ag.No. 11890 dt.4/8/2010 **SAMPLE DESCRIPTION** Water

14	Nitrate as NO <sub>3</sub>	mg/l	6.2	APHA 21 <sup>st</sup> EDI-4500- NO <sub>3</sub> <sup>-</sup> B	45
15	Fluoride as F	mg/l	0.18	APHA 21 <sup>st</sup> EDI-4500-F B&D	1.00
16	Iron as Fe	mg/l	0.56	IS : 3025 Part 53-2003	0.30
17	Ammonia as NH <sub>3</sub>	mg/l	0.07	APHA 21 <sup>st</sup> EDI-4500- NH <sub>3</sub> B&C	N.S.
18	Phosphate as PO <sub>4</sub>	mg/l	0.07	IS : 3025 Part 31-1988 (Reaff:2002)	N.S.

....END OF REPORT....

BDL – Below Detection Limit

N.S. - Not Specified

W1 - Sultan Bathery GP, Pudhuchola, Well Water. (Ward No: 03)

for ABC ENVIRON SOLUTIONS PVT. LTD.,

AUTHORIZED SIGNATORY

Page 2 of 2

This test results relate only to the items tested. Unless otherwise state of the results shown in this test report only to the sample(s) tested and such sample (s) are retained for 7 days in case of Wastewater and 30 days for all other samples. The samples from regulatory bodies are to be retained as specified. This document cannot be reproduced except in full, without prior written approval of the company.



**TEST REPORT**

<b>REPORT NO</b>	301	<b>DATE OF REPORT</b>	14-12-2010
<b>CUSTOMER NAME</b>	KRWSA, Kerala	<b>SAMPLE DESCRIPTION</b>	Water
<b>ADDRESS</b>	3 <sup>rd</sup> Floor, PTC Towers, S.S Kovil Road, Thampanoor Thiruvananthapuram-695001	<b>SAMPLE QUANTITY</b>	2 Ltrs
<b>REFERENCE NUMBER</b>	Ag.No. 11890 dt.4/8/2010	<b>SAMPLE RECEIVED ON</b>	09-12-2010
<b>SAMPLE COLLECTED BY</b>	ABC Environ Solutions Pvt.Ltd.	<b>DATE OF ANALYSIS</b>	09-12-2010
<b>SAMPLING METHOD</b>	IS: 3025 Part 1 – 1987	<b>COMPLETED ON</b>	13-12 -2010

S.NO	PARAMETER	UNIT	RESULTS	TEST PROCEDURE	Desirable Limit as per IS 10500 : 1991
			W1		
1	Physical Appearance	-	Pale Yellow	APHA 21 <sup>st</sup> EDI-2110	-
2	pH at 25°C	-	7.76	IS : 3025 Part 11- 1983 (Reaff: 2002)	6.5-8.5
3	Turbidity	NTU	1.4	IS : 3025 Part 10-1984 (Reaff: 2002)	5
4	Conductivity at 25°C	µS/cm	920	IS : 3025 Part 14- 1984 (Reaff: 2002)	N.S.
5	Total dissolved solids	mg/l	576	IS : 3025 Part 15-1984 (Reaff: 2003)	500
6	Total Alkalinity as CaCO <sub>3</sub>	mg/l	236	IS : 3025 Part 23- 1986(Reaff:2003)	200
7	Total Hardness as CaCO <sub>3</sub>	mg/l	215	IS : 3025 Part 21-1983 (Reaff: 1998)	300
8	Calcium as Ca	mg/l	62.3	IS : 3025 Part 40-1991 (Reaff:2003)	75
9	Magnesium as Mg	mg/l	14.6	APHA 21 <sup>st</sup> EDITION	30
10	Chloride as Cl <sup>-</sup>	mg/l	99	IS : 3025 Part 32-1988 (Reaff: 2003)	250
11	Sulphate as SO <sub>4</sub>	mg/l	4	APHA 21 <sup>st</sup> EDI-4500- SO <sub>4</sub> <sup>2-</sup> E	200
12	Sodium as Na	mg/l	70	IS : 3025 Part 45-1993 (Reaff:2003)	N.S.
13	Potassium as K	mg/l	69	IS : 3025 Part 45-1993 (Reaff:2003)	N.S.

Page 1 of 2

This test results relate only to the items tested. Unless otherwise state of the results shown in this test report only to the sample(s) tested and such sample (s) are retained for 7 days in case of Wastewater and 30 days for all other samples. The samples from regulatory bodies are to be retained as specified. This document cannot be reproduced except in full, without prior written approval of the company.



**TEST REPORT**

**REPORT NO** 301 **DATE OF REPORT** 14-12-2010  
**REFERENCE NUMBER** Ag.No. 11890 dt.4/8/2010 **SAMPLE DESCRIPTION** Water

14	Nitrate as NO <sub>3</sub>	mg/l	61	APHA 21 <sup>st</sup> EDI-4500- NO <sub>3</sub> <sup>-</sup> B	45
15	Fluoride as F	mg/l	0.36	APHA 21 <sup>st</sup> EDI-4500-F B&D	1.00
16	Iron as Fe	mg/l	BDL(<0.05)	IS : 3025 Part 53-2003	0.30
17	Ammonia as NH <sub>3</sub>	mg/l	0.48	APHA 21 <sup>st</sup> EDI-4500- NH <sub>3</sub> B&C	N.S.
18	Phosphate as PO <sub>4</sub>	mg/l	1.3	IS : 3025 Part 31-1988 (Reaff:2002)	N.S.

....END OF REPORT....

BDL – Below Detection Limit

N.S. - Not Specified

W1 - Sultan Bathery GP, Manichera-ST Colony, Well Water. (Ward No: 11)

for ABC ENVIRON SOLUTIONS PVT. LTD.,

AUTHORIZED SIGNATORY

Page 2 of 2

This test results relate only to the items tested. Unless otherwise state of the results shown in this test report only to the sample(s) tested and such sample (s) are retained for 7 days in case of Wastewater and 30 days for all other samples. The samples from regulatory bodies are to be retained as specified. This document cannot be reproduced except in full, without prior written approval of the company.



**TEST REPORT**

<b>REPORT NO</b>	302	<b>DATE OF REPORT</b>	14-12-2010
<b>CUSTOMER NAME</b>	KRWSA, Kerala	<b>SAMPLE DESCRIPTION</b>	Water
<b>ADDRESS</b>	3 <sup>rd</sup> Floor, PTC Towers, S.S Kovil Road, Thampanoor Thiruvananthapuram-695001	<b>SAMPLE QUANTITY</b>	2 Ltrs
<b>REFERENCE NUMBER</b>	Ag.No. 11890 dt.4/8/2010	<b>SAMPLE RECEIVED ON</b>	09-12-2010
<b>SAMPLE COLLECTED BY</b>	ABC Environ Solutions Pvt.Ltd.	<b>DATE OF ANALYSIS</b>	09-12-2010
<b>SAMPLING METHOD</b>	IS: 3025 Part 1 – 1987	<b>COMPLETED ON</b>	13-12 -2010

S.NO	PARAMETER	UNIT	RESULTS	TEST PROCEDURE	Desirable Limit as per IS 10500 : 1991
			W1		
1	Physical Appearance	-	Clear & Colourless	APHA 21 <sup>st</sup> EDI-2110	-
2	pH at 25°C	-	5.58	IS : 3025 Part 11- 1983 (Reaff: 2002)	6.5-8.5
3	Turbidity	NTU	BDL(<0.5)	IS : 3025 Part 10-1984 (Reaff: 2002)	5
4	Conductivity at 25°C	µS/cm	34	IS : 3025 Part 14- 1984 (Reaff: 2002)	N.S.
5	Total dissolved solids	mg/l	19	IS : 3025 Part 15-1984 (Reaff: 2003)	500
6	Total Alkalinity as CaCO <sub>3</sub>	mg/l	6	IS : 3025 Part 23- 1986(Reaff:2003)	200
7	Total Hardness as CaCO <sub>3</sub>	mg/l	6	IS : 3025 Part 21-1983 (Reaff: 1998)	300
8	Calcium as Ca	mg/l	1.6	IS : 3025 Part 40-1991 (Reaff:2003)	75
9	Magnesium as Mg	mg/l	BDL(<1)	APHA 21 <sup>st</sup> EDITION	30
10	Chloride as Cl <sup>-</sup>	mg/l	4	IS : 3025 Part 32-1988 (Reaff: 2003)	250
11	Sulphate as SO <sub>4</sub>	mg/l	BDL(<1)	APHA 21 <sup>st</sup> EDI-4500- SO <sub>4</sub> <sup>2-</sup> E	200
12	Sodium as Na	mg/l	2.6	IS : 3025 Part 45-1993 (Reaff:2003)	N.S.
13	Potassium as K	mg/l	BDL(<1)	IS : 3025 Part 45-1993 (Reaff:2003)	N.S.

Page 1 of 2

This test results relate only to the items tested. Unless otherwise state of the results shown in this test report only to the sample(s) tested and such sample (s) are retained for 7 days in case of Wastewater and 30 days for all other samples. The samples from regulatory bodies are to be retained as specified. This document cannot be reproduced except in full, without prior written approval of the company.



**TEST REPORT**

**REPORT NO** 302 **DATE OF REPORT** 14-12-2010  
**REFERENCE NUMBER** Ag.No. 11890 dt.4/8/2010 **SAMPLE DESCRIPTION** Water

14	Nitrate as NO <sub>3</sub>	mg/l	1	APHA 21 <sup>st</sup> EDI-4500- NO <sub>3</sub> <sup>-</sup> B	45
15	Fluoride as F	mg/l	BDL(<0.1)	APHA 21 <sup>st</sup> EDI-4500-F B&D	1.00
16	Iron as Fe	mg/l	BDL(<0.05)	IS : 3025 Part 53-2003	0.30
17	Ammonia as NH <sub>3</sub>	mg/l	BDL(<0.05)	APHA 21 <sup>st</sup> EDI-4500- NH <sub>3</sub> B&C	N.S.
18	Phosphate as PO <sub>4</sub>	mg/l	BDL(<0.01)	IS : 3025 Part 31-1988 (Reaff:2002)	N.S.

....END OF REPORT....

BDL – Below Detection Limit

N.S. - Not Specified

W1 - Enmakaje GP, Swarga, Open Water. (Ward No: 06)

for ABC ENVIRON SOLUTIONS PVT. LTD.,

AUTHORIZED SIGNATORY

Page 2 of 2

This test results relate only to the items tested. Unless otherwise state of the results shown in this test report only to the sample(s) tested and such sample (s) are retained for 7 days in case of Wastewater and 30 days for all other samples. The samples from regulatory bodies are to be retained as specified. This document cannot be reproduced except in full, without prior written approval of the company.





**TEST REPORT**

<b>REPORT NO</b>	303	<b>DATE OF REPORT</b>	14-12-2010
<b>CUSTOMER NAME</b>	KRWSA, Kerala	<b>SAMPLE DESCRIPTION</b>	Water
<b>ADDRESS</b>	3 <sup>rd</sup> Floor, PTC Towers, S.S Kovil Road, Thampanoor Thiruvananthapuram-695001	<b>SAMPLE QUANTITY</b>	2 Ltrs
<b>REFERENCE NUMBER</b>	Ag.No. 11890 dt.4/8/2010	<b>SAMPLE RECEIVED ON</b>	09-12-2010
<b>SAMPLE COLLECTED BY</b>	ABC Environ Solutions Pvt.Ltd.	<b>DATE OF ANALYSIS</b>	09-12-2010
<b>SAMPLING METHOD</b>	IS: 3025 Part 1 – 1987	<b>COMPLETED ON</b>	13-12 -2010

S.NO	PARAMETER	UNIT	RESULTS	TEST PROCEDURE	Desirable Limit as per IS 10500 : 1991
			W1		
1	Physical Appearance	-	Pale Yellow	APHA 21 <sup>st</sup> EDI-2110	-
2	pH at 25°C	-	7.78	IS : 3025 Part 11- 1983 (Reaff: 2002)	6.5-8.5
3	Turbidity	NTU	21.8	IS : 3025 Part 10-1984 (Reaff: 2002)	5
4	Conductivity at 25°C	µS/cm	345	IS : 3025 Part 14- 1984 (Reaff: 2002)	N.S.
5	Total dissolved solids	mg/l	214	IS : 3025 Part 15-1984 (Reaff: 2003)	500
6	Total Alkalinity as CaCO <sub>3</sub>	mg/l	168	IS : 3025 Part 23- 1986(Reaff:2003)	200
7	Total Hardness as CaCO <sub>3</sub>	mg/l	109	IS : 3025 Part 21-1983 (Reaff: 1998)	300
8	Calcium as Ca	mg/l	27.1	IS : 3025 Part 40-1991 (Reaff:2003)	75
9	Magnesium as Mg	mg/l	10.2	APHA 21 <sup>st</sup> EDITION	30
10	Chloride as Cl <sup>-</sup>	mg/l	6	IS : 3025 Part 32-1988 (Reaff: 2003)	250
11	Sulphate as SO <sub>4</sub>	mg/l	BDL(<1)	APHA 21 <sup>st</sup> EDI-4500- SO <sub>4</sub> <sup>2-</sup> E	200
12	Sodium as Na	mg/l	25.2	IS : 3025 Part 45-1993 (Reaff:2003)	N.S.
13	Potassium as K	mg/l	2.9	IS : 3025 Part 45-1993 (Reaff:2003)	N.S.

Page 1 of 2

This test results relate only to the items tested. Unless otherwise state of the results shown in this test report only to the sample(s) tested and such sample (s) are retained for 7 days in case of Wastewater and 30 days for all other samples. The samples from regulatory bodies are to be retained as specified. This document cannot be reproduced except in full, without prior written approval of the company.



**TEST REPORT**

REPORT NO 303 DATE OF REPORT 14-12-2010  
REFERENCE NUMBER Ag.No. 11890 dt.4/8/2010 SAMPLE DESCRIPTION Water

14	Nitrate as NO <sub>3</sub>	mg/l	BDL(<1)	APHA 21 <sup>st</sup> EDI-4500- NO <sub>3</sub> <sup>-</sup> B	45
15	Fluoride as F	mg/l	0.36	APHA 21 <sup>st</sup> EDI-4500-F B&D	1.00
16	Iron as Fe	mg/l	2.96	IS : 3025 Part 53-2003	0.30
17	Ammonia as NH <sub>3</sub>	mg/l	0.42	APHA 21 <sup>st</sup> EDI-4500- NH <sub>3</sub> B&C	N.S.
18	Phosphate as PO <sub>4</sub>	mg/l	0.12	IS : 3025 Part 31-1988 (Reaff.2002)	N.S.

....END OF REPORT....

BDL – Below Detection Limit

N.S. - Not Specified

W1 - Enmakaje GP, Kajampady, Bore well Water. (Ward No: 08)

for ABC ENVIRON SOLUTIONS PVT. LTD.,

AUTHORIZED SIGNATORY

Page 2 of 2

This test results relate only to the items tested. Unless otherwise state of the results shown in this test report only to the sample(s) tested and such sample (s) are retained for 7 days in case of Wastewater and 30 days for all other samples. The samples from regulatory bodies are to be retained as specified. This document cannot be reproduced except in full, without prior written approval of the company.



**TEST REPORT**

<b>REPORT NO</b>	304	<b>DATE OF REPORT</b>	14-12-2010
<b>CUSTOMER NAME</b>	KRWASA, Kerala	<b>SAMPLE DESCRIPTION</b>	Water
<b>ADDRESS</b>	3 <sup>rd</sup> Floor, PTC Towers, S.S Kovil Road, Thampanoor Thiruvananthapuram-695001	<b>SAMPLE QUANTITY</b>	2 Ltrs
<b>REFERENCE NUMBER</b>	Ag.No. 11890 dt.4/8/2010	<b>SAMPLE RECEIVED ON</b>	09-12-2010
<b>SAMPLE COLLECTED BY</b>	ABC Environ Solutions Pvt.Ltd.	<b>DATE OF ANALYSIS</b>	09-12-2010
<b>SAMPLING METHOD</b>	IS: 3025 Part 1 – 1987	<b>COMPLETED ON</b>	13-12 -2010

S.NO	PARAMETER	UNIT	RESULTS	TEST PROCEDURE	Desirable Limit as per IS 10500 : 1991
			W1		
1	Physical Appearance	-	Highly Turbid	APHA 21 <sup>st</sup> EDI-2110	-
2	pH at 25°C	-	6.81	IS : 3025 Part 11- 1983 (Reaff: 2002)	6.5-8.5
3	Turbidity	NTU	142	IS : 3025 Part 10-1984 (Reaff: 2002)	5
4	Conductivity at 25°C	µS/cm	169	IS : 3025 Part 14- 1984 (Reaff: 2002)	N.S.
5	Total dissolved solids	mg/l	96	IS : 3025 Part 15-1984 (Reaff: 2003)	500
6	Total Alkalinity as CaCO <sub>3</sub>	mg/l	70	IS : 3025 Part 23- 1986(Reaff:2003)	200
7	Total Hardness as CaCO <sub>3</sub>	mg/l	43.8	IS : 3025 Part 21-1983 (Reaff: 1998)	300
8	Calcium as Ca	mg/l	8.7	IS : 3025 Part 40-1991 (Reaff:2003)	75
9	Magnesium as Mg	mg/l	5.3	APHA 21 <sup>st</sup> EDITION	30
10	Chloride as Cl <sup>-</sup>	mg/l	12	IS : 3025 Part 32-1988 (Reaff: 2003)	250
11	Sulphate as SO <sub>4</sub>	mg/l	BDL(<1)	APHA 21 <sup>st</sup> EDI-4500- SO <sub>4</sub> <sup>2-</sup> E	200
12	Sodium as Na	mg/l	14	IS : 3025 Part 45-1993 (Reaff:2003)	N.S.
13	Potassium as K	mg/l	2.8	IS : 3025 Part 45-1993 (Reaff:2003)	N.S.

Page 1 of 2

This test results relate only to the items tested. Unless otherwise state of the results shown in this test report only to the sample(s) tested and such sample (s) are retained for 7 days in case of Wastewater and 30 days for all other samples. The samples from regulatory bodies are to be retained as specified. This document cannot be reproduced except in full, without prior written approval of the company.



**TEST REPORT**

**REPORT NO** 304 **DATE OF REPORT** 14-12-2010  
**REFERENCE NUMBER** Ag.No. 11890 dt.4/8/2010 **SAMPLE DESCRIPTION** Water

14	Nitrate as NO <sub>3</sub>	mg/l	BDL(<1)	APHA 21 <sup>st</sup> EDI-4500- NO <sub>3</sub> B	45
15	Fluoride as F	mg/l	0.40	APHA 21 <sup>st</sup> EDI-4500-F B&D	1.00
16	Iron as Fe	mg/l	6.7	IS : 3025 Part 53-2003	0.30
17	Ammonia as NH <sub>3</sub>	mg/l	0.77	APHA 21 <sup>st</sup> EDI-4500- NH <sub>3</sub> B&C	N.S.
18	Phosphate as PO <sub>4</sub>	mg/l	BDL(<0.01)	IS : 3025 Part 31-1988 (Reaff:2002)	N.S.

...END OF REPORT....

BDL – Below Detection Limit

N.S. - Not Specified

W1 - Kodumbollu GP, Chanakuzhi, Bore well Water. (Ward No: 13)

for ABC ENVIRON SOLUTIONS PVT. LTD.,

AUTHORIZED SIGNATORY

Page 2 of 2

This test results relate only to the items tested. Unless otherwise state of the results shown in this test report only to the sample(s) tested and such sample (s) are retained for 7 days in case of Wastewater and 30 days for all other samples. The samples from regulatory bodies are to be retained as specified. This document cannot be reproduced except in full, without prior written approval of the company.



**TEST REPORT**

<b>REPORT NO</b>	305	<b>DATE OF REPORT</b>	14-12-2010
<b>CUSTOMER NAME</b>	KRWSA, Kerala	<b>SAMPLE DESCRIPTION</b>	Water
<b>ADDRESS</b>	3 <sup>rd</sup> Floor, PTC Towers, S.S Kovil Road, Thampanoor Thiruvananthapuram-695001	<b>SAMPLE QUANTITY</b>	2 Ltrs
<b>REFERENCE NUMBER</b>	Ag.No. 11890 dt.4/8/2010	<b>SAMPLE RECEIVED ON</b>	09-12-2010
<b>SAMPLE COLLECTED BY</b>	ABC Environ Solutions Pvt.Ltd.	<b>DATE OF ANALYSIS</b>	09-12-2010
<b>SAMPLING METHOD</b>	IS: 3025 Part 1 – 1987	<b>COMPLETED ON</b>	13-12 -2010

S.NO	PARAMETER	UNIT	RESULTS	TEST PROCEDURE	Desirable Limit as per IS 10500 : 1991
			W1		
1	Physical Appearance	-	Highly Turbid	APHA 21 <sup>st</sup> EDI-2110	-
2	pH at 25°C	-	7.22	IS : 3025 Part 11- 1983 (Reaff: 2002)	6.5-8.5
3	Turbidity	NTU	145	IS : 3025 Part 10-1984 (Reaff: 2002)	5
4	Conductivity at 25°C	µS/cm	162	IS : 3025 Part 14- 1984 (Reaff: 2002)	N.S.
5	Total dissolved solids	mg/l	88	IS : 3025 Part 15-1984 (Reaff: 2003)	500
6	Total Alkalinity as CaCO <sub>3</sub>	mg/l	62	IS : 3025 Part 23- 1986(Reaff:2003)	200
7	Total Hardness as CaCO <sub>3</sub>	mg/l	50	IS : 3025 Part 21-1983 (Reaff: 1998)	300
8	Calcium as Ca	mg/l	9.6	IS : 3025 Part 40-1991 (Reaff:2003)	75
9	Magnesium as Mg	mg/l	6.3	APHA 21 <sup>st</sup> EDITION	30
10	Chloride as Cl <sup>-</sup>	mg/l	14	IS : 3025 Part 32-1988 (Reaff: 2003)	250
11	Sulphate as SO <sub>4</sub>	mg/l	BDL(<1)	APHA 21 <sup>st</sup> EDI-4500- SO <sub>4</sub> <sup>2-</sup> E	200
12	Sodium as Na	mg/l	8.4	IS : 3025 Part 45-1993 (Reaff:2003)	N.S.
13	Potassium as K	mg/l	1.6	IS : 3025 Part 45-1993 (Reaff:2003)	N.S.

Page 1 of 2

This test results relate only to the items tested. Unless otherwise state of the results shown in this test report only to the sample(s) tested and such sample (s) are retained for 7 days in case of Wastewater and 30 days for all other samples. The samples from regulatory bodies are to be retained as specified. This document cannot be reproduced except in full, without prior written approval of the company.



**TEST REPORT**

**REPORT NO** 305 **DATE OF REPORT** 14-12-2010  
**REFERENCE NUMBER** Ag.No. 11890 dt.4/8/2010 **SAMPLE DESCRIPTION** Water

14	Nitrate as NO <sub>3</sub>	mg/l	BDL(<1)	APHA 21 <sup>st</sup> EDI-4500- NO <sub>3</sub> B	45
15	Fluoride as F	mg/l	0.90	APHA 21 <sup>st</sup> EDI-4500-F B&D	1.00
16	Iron as Fe	mg/l	3.9	IS : 3025 Part 53-2003	0.30
17	Ammonia as NH <sub>3</sub>	mg/l	0.13	APHA 21 <sup>st</sup> EDI-4500- NH <sub>3</sub> B&C	N.S.
18	Phosphate as PO <sub>4</sub>	mg/l	BDL(<0.01)	IS : 3025 Part 31-1988 (Reaff:2002)	N.S.

....END OF REPORT....

BDL – Below Detection Limit

N.S. - Not Specified

W1 - Kodumbollu GP, Mupil, Bore well Water. (Ward No: 13)

for ABC ENVIRON SOLUTIONS PVT. LTD.,

AUTHORIZED SIGNATORY

Page 2 of 2

This test results relate only to the items tested. Unless otherwise state of the results shown in this test report only to the sample(s) tested and such sample (s) are retained for 7 days in case of Wastewater and 30 days for all other samples. The samples from regulatory bodies are to be retained as specified. This document cannot be reproduced except in full, without prior written approval of the company.



**TEST REPORT**

<b>REPORT NO</b>	306	<b>DATE OF REPORT</b>	14-12-2010
<b>CUSTOMER NAME</b>	KRWSA, Kerala	<b>SAMPLE DESCRIPTION</b>	Water
<b>ADDRESS</b>	3 <sup>rd</sup> Floor, PTC Towers, S.S Kovil Road, Thampanoor Thiruvananthapuram-695001	<b>SAMPLE QUANTITY</b>	2 Ltrs
<b>REFERENCE NUMBER</b>	Ag.No. 11890 dt.4/8/2010	<b>SAMPLE RECEIVED ON</b>	09-12-2010
<b>SAMPLE COLLECTED BY</b>	ABC Environ Solutions Pvt.Ltd.	<b>DATE OF ANALYSIS</b>	09-12-2010
<b>SAMPLING METHOD</b>	IS: 3025 Part 1 – 1987	<b>COMPLETED ON</b>	13-12 -2010

S.NO	PARAMETER	UNIT	RESULTS	TEST PROCEDURE	Desirable Limit as per IS 10500 : 1991
			W1		
1	Physical Appearance	-	Clear & Colourless	APHA 21 <sup>st</sup> EDI-2110	-
2	pH at 25°C	-	7.84	IS : 3025 Part 11- 1983 (Reaff: 2002)	6.5-8.5
3	Turbidity	NTU	BDL(<0.5)	IS : 3025 Part 10-1984 (Reaff: 2002)	5
4	Conductivity at 25°C	µS/cm	1828	IS : 3025 Part 14- 1984 (Reaff: 2002)	N.S.
5	Total dissolved solids	mg/l	1042	IS : 3025 Part 15-1984 (Reaff: 2003)	500
6	Total Alkalinity as CaCO <sub>3</sub>	mg/l	550	IS : 3025 Part 23- 1986(Reaff:2003)	200
7	Total Hardness as CaCO <sub>3</sub>	mg/l	468	IS : 3025 Part 21-1983 (Reaff: 1998)	300
8	Calcium as Ca	mg/l	83.8	IS : 3025 Part 40-1991 (Reaff:2003)	75
9	Magnesium as Mg	mg/l	62.9	APHA 21 <sup>st</sup> EDITION	30
10	Chloride as Cl <sup>-</sup>	mg/l	208	IS : 3025 Part 32-1988 (Reaff: 2003)	250
11	Sulphate as SO <sub>4</sub>	mg/l	17	APHA 21 <sup>st</sup> EDI-4500- SO <sub>4</sub> <sup>2-</sup> E	200
12	Sodium as Na	mg/l	166	IS : 3025 Part 45-1993 (Reaff:2003)	N.S.
13	Potassium as K	mg/l	9.0	IS : 3025 Part 45-1993 (Reaff:2003)	N.S.

Page 1 of 2

This test results relate only to the items tested. Unless otherwise state of the results shown in this test report only to the sample(s) tested and such sample (s) are retained for 7 days in case of Wastewater and 30 days for all other samples. The samples from regulatory bodies are to be retained as specified. This document cannot be reproduced except in full, without prior written approval of the company.



**TEST REPORT**

**REPORT NO** 306 **DATE OF REPORT** 14-12-2010  
**REFERENCE NUMBER** Ag.No. 11890 dt.4/8/2010 **SAMPLE DESCRIPTION** Water

14	Nitrate as NO <sub>3</sub>	mg/l	13	APHA 21 <sup>st</sup> EDI-4500- NO <sub>3</sub> <sup>-</sup> B	45
15	Fluoride as F	mg/l	2.1	APHA 21 <sup>st</sup> EDI-4500-F B&D	1.00
16	Iron as Fe	mg/l	0.90	IS : 3025 Part 53-2003	0.30
17	Ammonia as NH <sub>3</sub>	mg/l	0.20	APHA 21 <sup>st</sup> EDI-4500- NH <sub>3</sub> B&C	N.S.
18	Phosphate as PO <sub>4</sub>	mg/l	BDL(<0.01)	IS : 3025 Part 31-1988 (Reaff:2002)	N.S.

....END OF REPORT....

BDL – Below Detection Limit

N.S. - Not Specified

W1 - Eruthanpathy GP, Eruthenpathy, Bore well Water. (Ward No: 01)

for ABC ENVIRON SOLUTIONS PVT. LTD.,

AUTHORIZED SIGNATORY

Page 2 of 2

This test results relate only to the items tested. Unless otherwise state of the results shown in this test report only to the sample(s) tested and such sample (s) are retained for 7 days in case of Wastewater and 30 days for all other samples. The samples from regulatory bodies are to be retained as specified. This document cannot be reproduced except in full, without prior written approval of the company.





Annexure 6 - Water Borne Diseases in Kerala (2005-2009)

CHOLERA

District	2005		2006		2007		2008		2009	
	Attack	Death	Attack	Death	Attack	Death	Attack	Death	Attack	Death
Thiruvananthapuram	0	0	0	0	0	0	0	0	1	1
Kollam	0	0	0	0	0	0	0	0	0	0
Pathanamthitta	0	0	0	0	0	0	0	0	1	0
Alapuzha	6	0	1	0	0	0	0	0	20	1
Kottayam	3	0	0	0	0	0	0	0	0	0
Idukki	0	0	0	0	0	0	0	0	0	0
Ernakulam	10	0	9	0	0	0	0	0	0	0
Thrissur	1	0	0	0	0	0	0	0	2	0
Palakkad	3	0	2	0	5	0	4	0	0	0
Malappuram	0	0	0	0	0	0	0	0	0	0
Kozhikode	0	0	0	0	0	0	2	0	0	0
Wayanad	0	0	0	0	1	1	0	0	0	0
Kannur	0	0	0	0	0	0	0	0	0	0
Kasargod	0	0	0	0	0	0	0	0	0	0

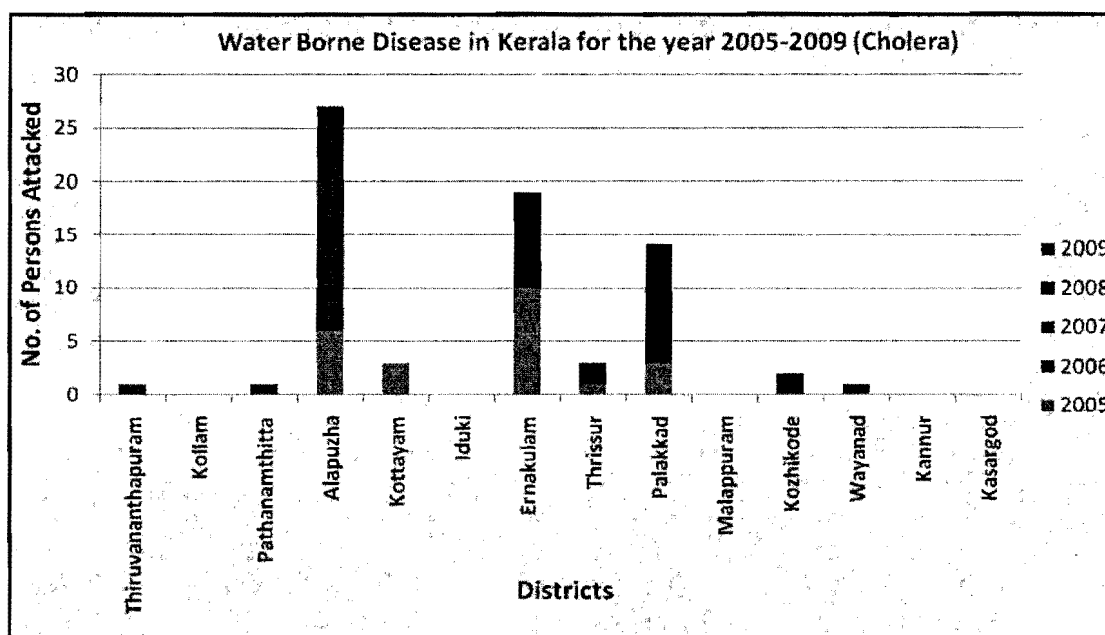

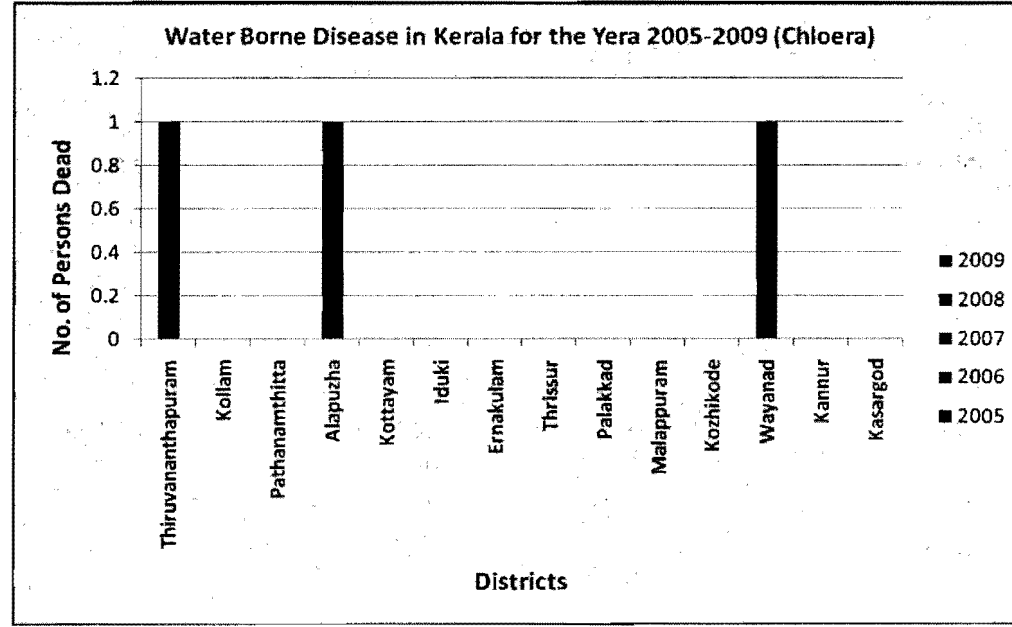

**ACUTE WATERY DIARRHOEA**

District	2005		2006		2007		2008		2009	
	Attack	Death	Attack	Death	Attack	Death	Attack	Death	Attack	Death
Thiruvananthapuram	28870	0	27457	0	24888	0	11210	0	13696	0
Kollam	38467	0	36561	0	18112	1	31429	0	24220	0
Pathanamthitta	14676	0	11014	0	9600	0	9481	0	7242	0
Alapuzha	28595	1	30282	0	27211	0	35194	0	42138	0
Kottayam	37162	1	26330	0	22354	0	21252	0	14892	0
Idukki	36831	0	27805		20339	0	23325	0	14138	0
Ernakulam	62046	0	58940	3	50039	0	38728	0	36639	0
Thrissur	63113	0	52790	0	55759	0	50960	0	60028	0
Palakkad	88358	3	77393	1	67080	3	71284	0	65639	2
Malappuram	130524	1	97128	1	101827	0	70626	0	64495	0
Kozhikode	49621	0	52153	0	44612	0	40346	0	42498	0
Wayanad	21314	0	21461	0	20708	0	19077	0	16414	0
Kannur	56130	0	49408	0	52000	0	32141	0	24270	0
Kasargod	30843	0	17676	0	16886	0	18010	0	17728	0



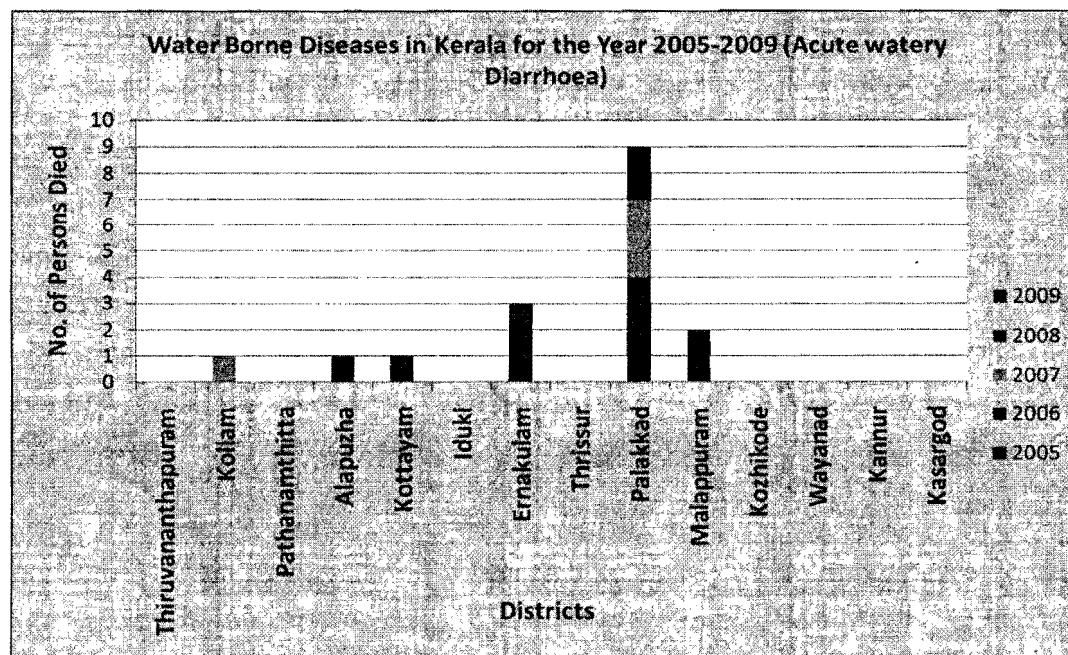
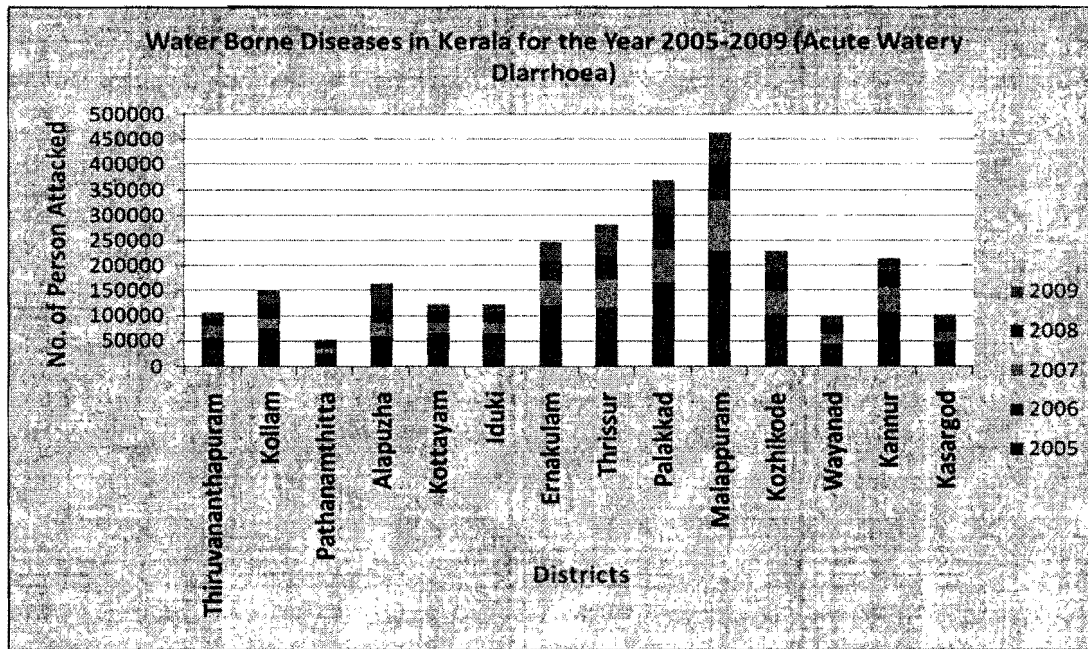

**PERSISTENT DIARRHOEA**

District	2005		2006		2007		2008		2009	
	Attack	Death	Attack	Death	Attack	Death	Attack	Death	Attack	Death
Thiruvananthapuram	104	0	437	0	679	0	176	0	7	0
Kollam	239	0	627	0	288	0	48	0	0	0
Pathanamthitta	0	0	0	0	0	0	0	0	0	0
Alapuzha	47	0	61	0	0	0	0	0	0	0
Kottayam	26	0	6	0	101	0	3	0	20	0
Idukki	0	0	9	0	0	0	0	0	15	0
Ernakulam	789	0	1	1	1	0	8	0	58	0
Thrissur	0	0	0	0	0	0	0	0	0	0
Palakkad	67	0	115	0	22	0	29	0	62	0
Malappuram	117	0	12	0	4	0	26	0	3	0
Kozhikode	1	0	1	0	1	0	0	0	0	0
Wayanad	0	0	0	0	0	0	0	0	0	0
Kannur	89	0	111	0	208	0	2	0	1	0
Kasargod	3	0	2	0	72	0	10	0	0	0

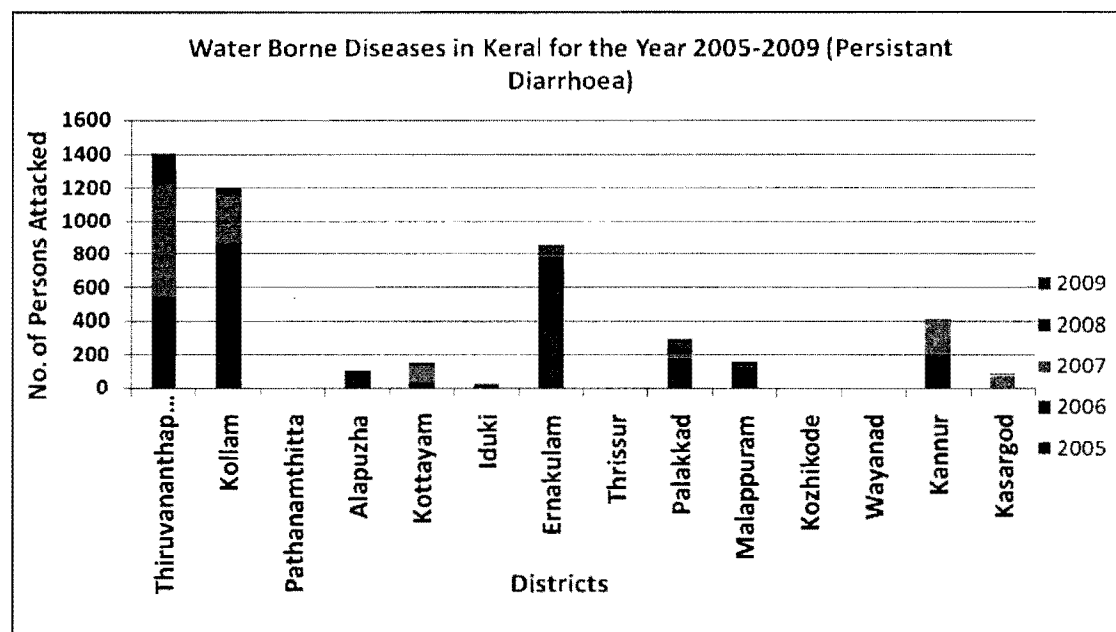

DYSENTERY

District	2005		2006		2007		2008		2009	
	Attack	Death	Attack	Death	Attack	Death	Attack	Death	Attack	Death
Thiruvananthapuram	3893	0	3364	0	1889	0	340	0	55	0
Kollam	3237	0	1612	0	445	0	633	0	578	0
Pathanamthitta	2685	0	1573	0	1340	0	893	0	187	0
Alapuzha	1054	0	826	0	481	0	610	0	504	0
Kottayam	2784	0	1569	0	1904	0	1423	0	1199	0
Idukki	1563	0	1049	0	287	0	30	0	54	0
Ernakulam	5245	0	1979	0	1318	0	997	0	420	0
Thrissur	1810	0	787	0	711	0	195	0	172	0
Palakkad	2292	0	1775	0	1360	0	1027	0	864	0
Malappuram	3062	0	1610	0	1765	0	1431	0	1265	0
Kozhikode	252	0	262	0	107	0	242	0	51	0
Wayanad	459	0	774	0	209	0	9	0	15	0
Kannur	1212	0	1008	0	556	0	119	0	153	0
Kasargod	1146	0	302	0	376	0	191	0	103	0

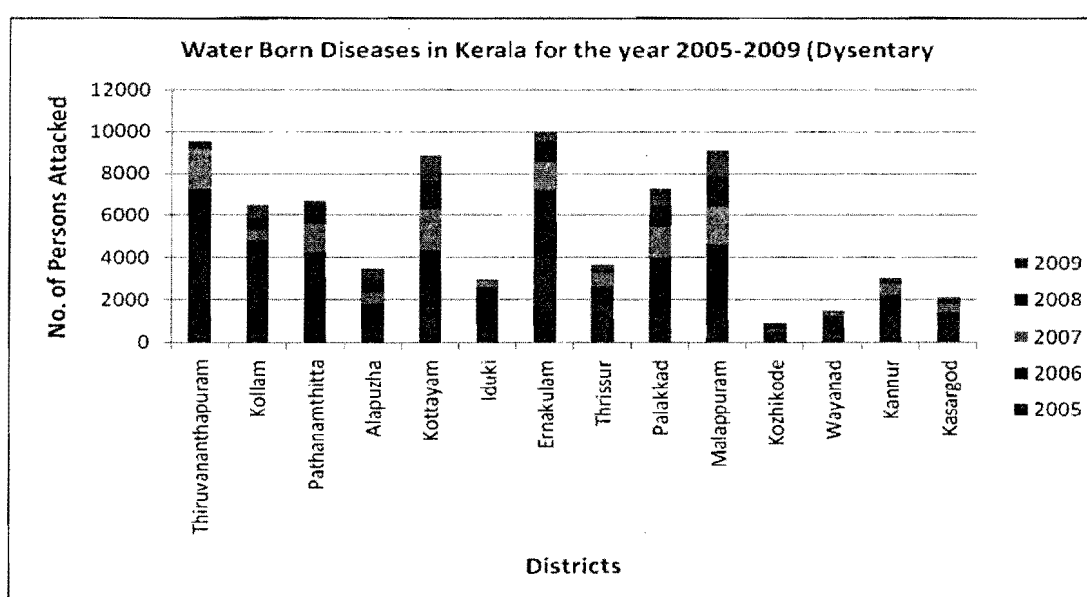

Source: Directorate of health Services, ORT (Oral Rehydration Therapy) Reports, 2005-2009

**Annexure 7 - FGD Report**

REPORT 1 KALIYOOR.....	165
REPORT 2 KOTTUKAL .....	173
REPORT 3 THIRUKOVILVATTAM.....	181
REPORT 4 EZHUPUNNA.....	189
REPORT 5 RAMANAKARY .....	195
REPORT 6 PAMPAKUDA .....	202
REPORT 7 ERIYAD.....	209
REPORT 8 AGALI.....	214
REPORT 9 ERUTHENPATHY .....	220
REPORT 10 THIRURANGADI.....	227
REPORT 11 SULTHAN BATHERY .....	233
REPORT 12 RAMANATTUKARA .....	240
REPORT 13 ENMAKAJE.....	246
REPORT 14 KODOM BELUR .....	253

**REPORT 1 KALIYOOR**
**VILLAGE SURVEY FORMAT**

<b>Identification</b>	
Name of the District	Thiruvananthapuram
Name of the Block	Athiyanoor
Name of the Gram Panchayat	Kaliyoor
Name of the Villages	Kaliyoor
Terrain	Plain
Area in Acres	17.23 sq. kms
Population	36,836 as per 2001 census
Distance from the Gram Panchayat	45 kms from Thiruvananthapuram town
Depth of water table (Location wise)	10 m
<b>Water Supply</b>	
Type of Scheme	Kerala water Authority
Source of Water	Bore Well, canal and lake
Is the well open or covered	Open
Whether the well is Sanitized	Yes
Source of water in summer	Less
Type of distribution network	Pipeline
How drinking water is met in coastal area?	There is no coastal area
Main source of drinking water	1. Panchayat Tap 2. Hand Pump 3. Public Open Well/Individual Open well
Is there any treatment in case of open well?	Yes
If yes, what treatment is followed?	1. Chlorination 2. Filtering through cloth
How many households are boiling water & drinking?	80 %
Whether water is boiled or only heated	Boiled
How is the cost aspect maintained for treatment?	By Gram Panchayat
What is the village institutional arrangement for drinking water treatment? Who does the treatment, how often and is it working well?	No
Handling of drinking water	1. Cover 2. Pot or tank with tap
Supply Duration	From 2 Hrs to 6 Hrs
Supply Frequency	Once in 4 Days
Number of	1. Bore Well - 13 2. Common well - 24 3. Lake -1 4. Canal -1
Storage Capacity	1.5 Lakhs litres
Depth of the aquifer (if it is ground water)	50 metres
Is there decline in ground water level	



Summer	Yes	
Winter	No	
Is there any maintenance shut down if the source from a canal	No	
Cost for the Water Supply/HH	Rs 60/ Month	
Annual O & M expenditure	O & M expenditure is borne by contractor	
Repair and Maintenance	By contractor	
Power	KSEB	
Whether Technical support is given for O&M?	No	
What type of support?	No	
Is there is any Rain Water Harvesting Scheme	No	
Is there any conflict between villages for water?	No	
<b>Water Quality</b>		
Quality Perception	1. Muddy 2. Bacterial	3. Iron content
Surface water quality in the time of low level flow	Fair	
How often the water quality is checked?	There is no periodical checking of water quality	
Any records maintained for water quality?	Nil	
Quality Parameter (Specify parameter and value in ppm)	Nil	
Treatment	No	
Type of Treatment	Chlorination	
Type of Storage	OHT	
<b>Environmental Sanitation</b>		
Nature of Defecation	1. Individual Sanitary latrine(ISL) 2. Open	
Number of ISL		
ISL Coverage (% of Households)	90 %	
No. of Public latrines	No	
Whether the latrine is conversion of leach pit to shallow two pit or new	No	
How sanitation is managed in coastal areas or hills?	There is no coastal area	
Is your ISL/Public Latrine connected to	Leachate pit	
How often and what process is followed to empty the pits and tanks?	Once the Leachate pit is full, they will put concrete on the Leachate pit	
Where other people go for defecation	In the field/Near the Water Resource	
Is there any wastewater body	No	
Is there any drinking water source near the wastewater body	No	
Septic tank/Leachate pit waste disposal	They closed the pit	
Use of waste as Manure	No	



Presence of Sewerage connection	No
Sewerage Coverage (% of households)	No
Sewage Treatment	No
Where Sewerage is disposed finally	Sewage is disposed in open area
Solid Waste	
Where do you dispose solid waste	In the open area
Where do you dispose fodder waste dung	House backyard
Do you have compost pit for this waste	No
Locations	No
Distance from village (Km)	Not applicable
What is done with the waste	burnt
Health & Personal Hygiene	
Health facility	Public Health Centre and Ayurvedic dispensary
Health Staff in Village	Govt Doctor
When do you wash hands?	1. Before & after eating 2. After Defecation
What is used for cleaning hands?	Soap
Frequency of bathing	1. Daily 2. Once in two days
What kind of hygiene messages do villagers most often hear during programs and campaigns and are these useful?	
Common diseases	1. Common Cold & fever 2. Diarrhoea 3. Skin diseases
How often is the disease outbreak	Seasonal
Was there a health epidemic due to contaminated water in the past two years?	No
Awareness	
Awareness programs regarding water & sanitation taken up?	Awareness program is conducted by staff of Gram Panchayat and public health centres
How you protect drinking water sources?	Nil
Is there any occasion where the whole village is cleaned & sanitized compulsorily	No

#### FIELD STUDY ON 22<sup>nd</sup> NOVEMBER, 2010

Field study was conducted at Kaliyoor Gram Panchayat on 22<sup>nd</sup> November, 2010. The GP is located in Nemon Block (Thiruvananthapuram District). The GP is about 45 Km from Thiruvananthapuram. The total area of the GP is about 17.23 Sq.Km. As per 2001 census, the population is about 36836. The GP has 1 village, Kaliyoor with 20 wards. The topography is flat terrain.





Kaliyoor Gram Panchayat

**a) SOURCE OF WATER AND WATER SUPPLY**

- Since last 20 years, people get water from Kerala Rural Water Supply Scheme and it's the only scheme available in the GP.
- Pump house is available only at Mukaloormula ward (ward no: 3). The source of water is Vandithadam tank. Water is supplied to agricultural college, Pumkulum, Vandithadam, Palapooore, Kaliyoor, Kunnampara road from this pump house.
- Water is supplied weekly once or twice. Submersible pump of 60 HP is used. Pumping is done on shift basis.
- In Nadungal, from over head tank of 1.5 lakhs capacity, water is pumped and supplied to households by individual pipeline. For new pipeline connection, HH have to pay Rs.4000 - 5000 and for water meter Rs. 500. Water is supplied weekly 4 days.
- In Vellayani (ward no.2) one pup house is there but not functioning. The source of water is Vellayani Lake. Due to silt accumulation, pumped water was muddy and pumping was stopped.



Closed Pump House in Vellayani

- Pump House in Kakkamoola ward (Ward 18) is functioning for more than 20 years. The pump house has 4 pumps, 1 with the capacity of 60 HP, 3 with 20HP and the OHT is in Peringamala having the capacity of 15 lakh litres. Source of water is Nedinjal thodu. Water is potable and the water is available during summer, but frequency of pumping will be less. The pump house is having filtration system.



**Kakkamoola Pump House**

- In Santhivilla (ward No.3), the pump house is not maintained properly by the operator. Pumping is done continuously and as the pump house is locked, water overflows and floods the main road.



**Santhivilla Pump House**



**Over Flow of Water  
from the Pump House**



**Improper Maintenance In The Pump  
House**



**Overflow into the main roads**

**b) WATER QUALITY**

- The quality of the water supplied from the Kakkamoola pump house is good.
- Water from the Santhivilla pump house is muddy.
- The main reason for non -functioning of Vellayani Pump house is Silt accumulation. Samples were collected from lake during the visit and the results are also enclosed in **Annexure 5**.

**c) SOLID WASTE**

- Solid wastes generated from households are disposed in canal, ponds and lakes. There is no proper solid waste collection and disposal facility in the village.
- People are dumping waste in the backyard.
- There is no separate sewerage system.
- Sewage is disposed in nearby canal and ponds.
- Water in the canal water polluted due to waste (solid & liquid) disposal and it cannot be used for any purpose.
- Pollution of Vellayani lake is due to Solid Waste Disposal from Kizhakke colony and also waste from agricultural college leads to pesticides contamination in the lake.

**d) ENVIRONMENTAL SANITATION**

- 90% of the houses have good latrine facility and in some places open defecation is noticed.
- There is no common latrine in the GP.

**e) HEALTH AND HYGIENE**

- GP is having Primary Health Centre in Kaliyoor and in Vellayani. There is also an Ayurveda Dispensary in Kaliyoor.
- With the help of the Panchayat the Primary Health Centre is conducting many health and awareness camps.
- They also provide bleaching powder and medicines to each household during rainy days.



FOCUSSED GROUP DISCUSSION HELD ON 23.11.2010 AT KALIYOOR,  
THIRUVANANTHAPURAM DISTRICT

- A. All the GP members and villagers actively participated in the FGD.
- B. People that water from the Santhivilla pump house is very muddy and even if boiled, sediment can be noticed.
- C. Water is supplied without any treatment and the people expected some treatment system for drinking water.
- D. Opinion regarding increasing the capacity of storage tank was given.
- E. People informed that there are 24 common wells in the Panchayat and mostly they are not in use due to contamination and suggested that it can be used if any treatment is provided, which will in turn reduce water scarcity in the region.
- F. The depth of the aquifer is about 150 feet.
- G. The ward members and the villagers expressed their interest for implementing Jalanidhi-2.
- H. There is no rain water harvesting system in the GP and they expressed their interest in RWH in every household.
- I. In ward 20 (Signal Station) one mini pump house is there and the President suggested that by increasing the capacity of the tank, water can be supplied to more areas.
- J. There are two fresh water ponds in the GP (ie), Elathara Kulam and Thenoor Kulam, which are not in use due to the contamination due to bathing, washing clothes etc.,
- K. They also discussed about pollution of Vellayani lake due to the solid waste disposal. The lake is enriched with nutrient and leading to eutrophication, which will reduce the dissolved oxygen level in the water and affect the living organism in the water.

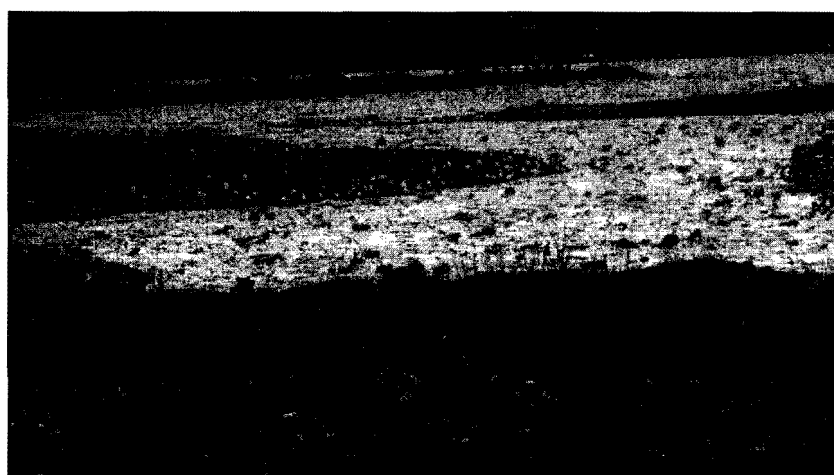

Eutrophication of Vellayani Lake

- L. They also suggested raising a compound wall to protect the lake from flood and sewage disposal.
- M. Netherlands Waste Scheme is now conducting a research in Kaliyoor GP to implement waste treatment in that GP.

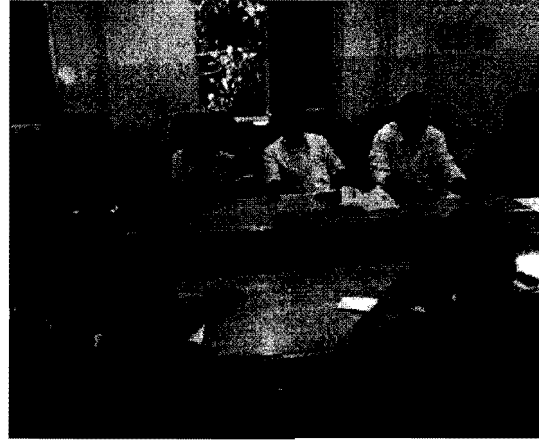

FGD at Kaliyoor Gram Panchayat

**REPORT 2 KOTTUKAL**  
**VILLAGE SURVEY FORMAT**

<b>Identification</b>	
Name of the District	Thiruvananthapuram
Name of the Block	Athiyanoor
Name of the Gram Panchayat	Kottukal
Name of the Villages	Kottukal
Terrain	Sloping
Area in Acres	
Population	31,827 as per 2001 census
Distance from the Gram Panchayat	15 kms from Thiruvananthapuram town
Depth of water table (Location wise)	10 metres
<b>Water Supply</b>	
Type of Scheme	Kerala water Authority
Source of Water	Bore Well, River(6 river branches), lake (Karichial lake), spring(23 Springs), Stream(27)
Is the well open or covered	Open
Whether the well is Sanitized	Yes
Source of water in summer	Less
Type of distribution network	Pipeline
How drinking water is met in coastal area?	The drinking water is met by near by wells which is having good water
Main source of drinking water	Panchayat Tap Hand Pump Public Open Well/Individual Open well
Is there any treatment in case of open well?	Yes
If yes, what treatment is followed?	1. Chlorination 2. Alum or herbs 3. Filtering with cloth
How many households are boiling water & drinking?	80 %
Whether water is boiled or only heated	Boiled
How is the cost aspect maintained for treatment?	By Gram Panchayat
What is the village institutional arrangement for drinking water treatment? Who does the treatment, how often and is it working well?	No
Handling of drinking water	1. Cover 2. Pot or tank with tap
Supply Duration	From 2 Hrs to 6 Hrs
Supply Frequency	Daily/ Once in 3 Days
Number of	Well - 40 Stream - 27

	Springs - 23	
Storage Capacity	3 lakhs litres	
Depth of the aquifer (if it is ground water)	50 metres	
Is there decline in ground water level		
Summer	Yes	
Winter	No	
Is there any maintenance shut down if the source from a canal	No	
Cost for the Water Supply	Rs 45/ Month	
Annual O & M expenditure	O & M expenditure is borne by contractor	
Repair and Maintenance	By contractor	
Power	KSEB	
Whether Technical support is given for O & M?	No	
What type of support?	No	
Is there is any Rain Water Harvesting Scheme	RWH tank is available at Chinnanvila colony and Punnankulam	
Is there any conflict between villages for water?	No	
<b>Water Quality</b>		
Quality Perception	<ul style="list-style-type: none"> <li>➤ Muddy</li> <li>➤ Bacterial</li> </ul>	<ul style="list-style-type: none"> <li>➤ Iron</li> </ul>
Surface water quality in the time of low level flow	Good	
How often the water quality is checked?	There is no periodical checking of water quality	
Any records maintained for water quality?	Nil	
Quality Parameter (Specify parameter and value in ppm)	Nil	
Treatment	No	
Type of Treatment	Chlorination	
Type of Storage	OHT	
<b>Environmental Sanitation</b>		
Nature of Defecation	<ul style="list-style-type: none"> <li>➤ Individual Sanitary latrine(ISL)</li> <li>➤ Public latrines</li> <li>➤ Open</li> </ul>	
Number of ISL		
ISL Coverage (% of Households)	15 %	
No. of Public latrines	5	
Whether the latrine is conversion of leach pit to shallow two pit or new	No	
How sanitation is managed in coastal areas & hills?	There is no management of sanitation	
Is your ISL/Public Latrine connected to	Leachate pit	



How often and what process is followed to empty the pits and tanks?	Once the Leachate pit is full, it is covered with a slab	
Where other people go for defecation	In the field/Near the Water Resource	
Is there any wastewater body	No	
Is there any drinking water source near the wastewater body	No	
Septic tank/Leachate pit waste disposal	They close the pit	
Use of waste as Manure	No	
Presence of Sewerage connection	No	
Sewerage Coverage (% of households)	No	
Sewage Treatment	No	
Where Sewerage is disposed finally	Sewage is disposed in the field	
<b>Solid Waste</b>		
Where do you dispose solid waste	In the open area	
Where do you dispose fodder waste dung	House backyard	
Do you have compost pit for this waste	No	
Locations	No	
Distance from village (Km)	Not applicable	
What is done with the waste	Burnt	
<b>Health &amp; Personal Hygiene</b>		
Health facility	Public Health Centre	
Health Staff in Village	Govt Doctor	
When do you wash hands?	1. Before & after eating 2. After Defecation	
What is used for cleaning hands?	Soap	
Frequency of bathing	1. Daily 2. Once in two days	
What kind of hygiene messages do villagers most often hear during programs and campaigns and are these useful?		
Common diseases	Common Cold & fever Diarrhoea	Skin diseases Viral Hepatitis - A
How often is the disease outbreak	Seasonal	
Was there a health epidemic due to contaminated water in the past 2 yrs?	No	
<b>Awareness</b>		
Awareness programs regarding water & sanitation taken up?	Awareness program is conducted by Gram Panchayat and Public Health Centres	
How you protect drinking water sources?	Nil	
Is there any occasion where the whole village is cleaned & sanitized compulsorily	No	

**FIELD STUDY ON 16<sup>TH</sup> NOVEMBER, 2010**

Field Study was conducted at Kottukal on 16<sup>th</sup> November, 2010. The GP is located in Athiyanoor Block of Thiruvananthapuram District and is about 15 Km from Thiruvananthapuram. As per 2001 census, the total population is about 31,827 and as per the voters list it's about 43,000. There are 19 wards. The terrain is sloping.

**a) SOURCE OF WATER AND WATER SUPPLY**

- KWA water supply scheme is available. Water is pumped from bore well and canals and supplied to households but water availability is less during summer.
- Water distributed through pipelines but no proper distribution system is available for most of the wards.
- Other sources of water are lake, river, spring, stream and wells.
- There are about 40 wells (mostly not in use), 23 springs and 27 streams in the GP.
- There are 11KWA schemes available in the GP and the major pump houses are located in Oochakada, Puthalam, and Kollamkonam.
- Pump house in Oochakada is the major source of the water to the GP and the pump house covers major areas of the GP. Water is also supplied to nearby GPs.
- The pump capacity is 75 HP and from the pump house, about 3, 00,000 litres of water is pumped daily. The depth of the well is about 30 feet. Stand by motor is not available. Hence if there is any repair in motor / pump, water supply will be impeded.
- The water quality is very good. Only chlorination is done in the pump house. There is a storage gallery and after pumping, water is stored in the gallery for future supply. During rainy season, excess water is stored in the gallery and overflows to nearby waste lands.



Discussion with the Pump House Operator at Uchakada Pump House



Storage Gallery at Uchakada Pump House

- The supply is twice a week with the duration of more than 2 hours. Water is distributed through the PVC pipelines.

- The water tariff is Rs.43 for 10,000 litres and if water usage exceeds beyond 10 KLD, Rs.6 per litre is charged extra.
- There is a valve for each area having minimum of 40 to 50 households, to maintain uniform distribution of the water for each area. Meter is fixed for each household to calculate water usage.



Street Valve

- Operation and maintenance is carried out only by the contractors.
- A pump house supervisor is appointed to operate the pump house and salary is provided by the contractors.
- Pump house at Puthalam, pumps about 2, 00,000 litres of water daily. The depth of the well is 50 feet. Stand by motor is available in the pump house but non functional. The main source of the water for this pump house is bore well and Spring. During rainy season the availability of spring water is more and in summer the availability is poor. Chlorination is the only treatment provided in the pump house.

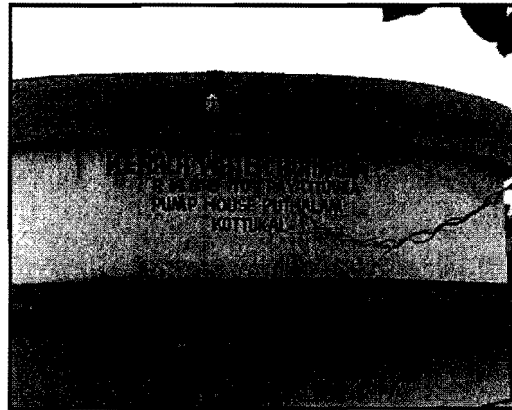

Pump House at Puthalam

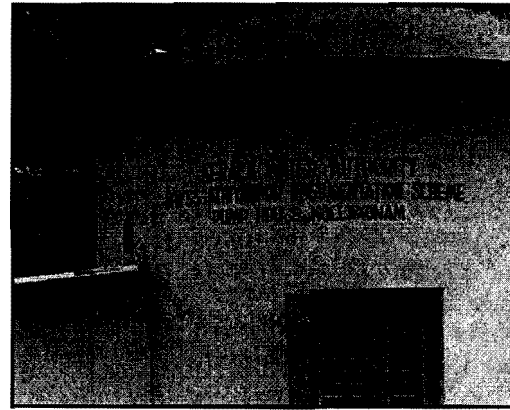

Pump house at Kollamkonam

- There are 2 pump houses in Kollamkonam. The source of water for the two pump houses are nearby canal. The pump capacity is 25 HP and the depth of the well is about 30 feet. Water is not potable and people are using the water for bathing, washing etc.,
- Distribution of water is through the pipelines and there are more than 2 public taps in each street.

**b) RAIN WATER HARVESTING**

- Rain Water harvesting system is provided only at Chinnanvilla Colony (Ward No.15). It was facilitated by Shanthigram & Mitraniketan, supported by Department of Science & Technology, Government of India and maintained by SYCAMORE Trust, an NRI trust running successfully.
- More than 680 households are benefited by the scheme. The households are using water for washing, bathing and for other purposes, but water will be available only during rainy season.



**Rain Water Harvesting System in  
Chinnanvilla Colony**



**Rain Water Harvesting System in  
Punnankulam**

- In Punnankulam the rain water harvesting scheme is available only in one house and they get water during rainy season which is used for washing, bathing and for other purposes.

**c) WATER QUALITY**

- The quality of water supplied from the Kollamkonam pump house is poor. The colour of the water is yellowish. Due to the solid waste disposal into the canal water is contaminated.
- The water sample was collected and the results are enclosed.
- People expressed that, they could find sediment when water is stored in pot or container and even if boiled the taste is not good.



Canal Water with Yellow colour

- In Moolakara (Ward No.7) water supply is from canal and water source for this canal is Kallikadu Dam. Water has hardness and by consuming the water, people are affected by throat infections.
- In Punnankulam ward (ward No.14) only hard water used and scale formation is seen in vessels while boiling water.
- As Ambalathumula is near coast, they get only the saline water for drinking. About 200 families are affected due to water quality but now water is available for drinking from nearby well in the church.
- Water quality is not checked periodically.

**d) SOLID WASTE**

- Dispose of solid waste is done inside the village.
- Dispose of fodder waste and dung is in house backyard and in some houses cow dung cake is used as a combustion material.
- Cow dung is also used as manure.
- Due to the improper sanitation and solid waste management system, the canal is contaminated. Waste from hotels is disposed directly in to the canal in Nellimode.
- No composting of waste is done. Waste is burnt or simply thrown in the streets

**e) ENVIRONMENTAL SANITATION**

- 15% of HH do not have Individual Sanitary Latrines (ISL) and open defecation is common.
- The ISL is connected with leachate pit only.
- There are five public latrines in the GP of which one public latrine is in market.
- There is no sewerage connection throughout the GP and sewage is disposed finally in to open area or nearby pond.

**f) HEALTH & PERSONAL HYGIENE**

- Primary Health Centre, Homeopathy Hospital, Ayurvedic Hospitals are available in the GP and doctors are readily available.
- National Rural Health Department is available and there are 8 sub centres for this department.

- During rainy season, Public Health Department provides bleaching power to households having wells. With the help of the Panchayat they conduct health \ and awareness programmes.

**FOCUSED GROUP DISCUSSION HELD ON 17.11.2010 AT KOTTUKAL,  
THIRUVANANTHAPURAM DISTRICT**

Total No. of people participated in the FGD are 16. The President, Vice President, members of the various wards, Anganvadi teachers, school teachers and women participated in the FGD and issues related to water supply, quality of water, sanitation etc was discussed. Following are the outcome of FGD.



**Focused Group Discussion**

- A. All the members and villagers actively participated in the FGD.
- B. Pump house supervisor of Uchakada pump house suggested that since the pump house is the major water source for the GP, another storage gallery to store water during rainy season will help to store the overflow which otherwise cause the flood in that area.
- C. The village people suggested providing some treatment for 40 common wells in Panchayat, which are contaminated.
- D. In Chinnanvilla Colony there are 680 households and there is one common well near the SYCAMORE Trust which is contaminated. With the help of the RWH system, water is made available for washing, cleaning and other uses. Since there is water scarcity for drinking, people suggested, cleaning of well will make the water potable.
- E. There is severe water scarcity during summer as water availability is reduced by 25%.
- F. In Thekkekonam, the RWSS Scheme is not functioning due to improper maintenance.
- G. Due to scarcity of water, households having well, sell the water for Rs.300/1000 litres.
- H. People expressed their willingness to new water scheme and Panchayat is also willing to pay 10%.
- I. As water from Kollamkonam pump houses is not potable, people suggested treatment of water and regular water quality monitoring.

## REPORT 3 THIRUKOVILVATTAM

## VILLAGE SURVEY FORMAT

<b>Identification</b>	
Name of the District	Kollam
Name of the Block	Mukhathala
Name of the Gram Panchayat	Thrikkovilvattam
Name of the Villages	Thaikkovilvattum,Thazhuthala,Kottankara
Terrain	Sloping
Area in Acres	18.66 sq.km
Population	5,39,195(as per 2001 census)
Distance from the Gram Panchayat	15 km from Kollam junction
Depth of water table (Location wise)	Ranges between 20-30 ft (bgl)
<b>Water Supply</b>	
Type of Scheme	(KWA) Kerala Water Authority
Source of Water	Bore Well / Canal
Is the well open or covered	Open
Whether the well is Sanitized	Yes
Source of water in summer	Canal
Type of distribution network	Through street pipelines
How drinking water is met in coastal area?	N/A
Main source of drinking water	1. Panchayat Tap 2.Hand Pump 3.Public Open Well/Individual Open well
Is there any treatment in case of open well?	Yes
If yes, what treatment is followed?	Chlorination
How many households are boiling water & drinking?	80% of the population
Whether water is boiled or only heated	Boiled
How is the cost aspect maintained for treatment?	It is met through the help of public health centre and ASHA groups (Aided by govt.)
What is the village institutional arrangement for drinking water treatment? Who does the treatment, how often and is it working well?	KWA authorizes the treatment through private contraction. The treatment includes only the disinfection by chlorination .This activity is carried out daily and it is working well.
Handling of drinking water	Pot or tank with tap
Supply Duration	5 - 6 hours
Supply Frequency	Twice in a week
Number of	Tanks - 4 Tube well- 7
Storage Capacity	Tank capacity of 1,20,000 litres proposed by KWA 75000 of water from the Panchayat well
Depth of the aquifer (if it is ground water)	300 - 350 ft depth



Is there decline in ground water level 1. Summer 2. Winter	Yes No
Is there any maintenance shut down if the source from a canal	No
Cost for the Water Supply/ HH	Rs 45 to Rs 60 per month
Annual O & M expenditure	
Repair and Maintenance	By contractors
Power	KSEB
Whether Technical support is given for O & M?	No
What type of support?	-
Is there is any Rain water Harvesting Scheme	-
Is there any conflict between villages for water?	No
<b>Water Quality</b>	
Quality Perception	<ul style="list-style-type: none"> <li>➤ Muddy</li> <li>➤ Salty</li> <li>➤ Bacterial or Chemical</li> <li>➤ Iron content</li> </ul>
Surface water quality in the time of low level flow	Fair
How often the water quality is checked?	Others
Any records maintained for water quality?	No
Quality Parameter (Specify parameter and value in ppm)	No
Treatment	Yes
Type of Treatment	Chlorination
Type of Storage	Over head tank
<b>Environmental Sanitation</b>	
Nature of Defecation	Individual Sanitary latrine(ISL)
Number of ISL	approximately 102447 households
ISL Coverage (% of Households)	95%
No. of Public latrines	No
Whether the latrine is conversion of leach pit to shallow two pit or new	Mostly shallow two pit latrine and some households there are leach pits and new latrines are found.
How sanitation is managed in coastal areas & hills?	N/A
Is ISL/Public Latrine connected to	Leachate pit
How often and what process is followed to empty the pits and tanks?	They close the pit
Where other people go for defecation	In the field and Near the Water Resource
Is there any wastewater body	Yes



Is there any drinking water source near the wastewater body	No
Septic tank/Leachate pit waste disposal	1. Leachate pit
Use of waste as Manure	No
Presence of Sewerage connection	No
Sewerage Coverage (% of households)	No
Sewage Treatment	No
Where Sewerage is disposed finally	Let into the streams
<b>Solid Waste</b>	
Where do you dispose solid waste?	Inside the village
Where do you dispose fodder waste dung?	House backyard
Do you have compost pit for this waste	No
Locations	-
Distance from village (Km)	-
What is done with the waste	Burnt
<b>Health &amp; Personal Hygiene</b>	
Health facility	Public Health Centre
Health Staff in Village	Govt. Doctor
When do you wash hands?	1. Before & after eating 2. After Defecation
What is used for cleaning hands?	Others
Frequency of bathing	Daily
What kind of hygiene messages do villagers most often hear during programs and campaigns and are these useful?	Cleanliness is godliness
Common diseases	Common Cold & fever
How often is the disease outbreak	Monthly during winter season
Was there a health epidemic due to contaminated water in the past two years?	Yes
<b>Awareness</b>	
Awareness programs regarding water & sanitation taken up?	Yes, It is conducted by ASHA and public health centre and village Panchayat
How you protect drinking water sources?	There is no protection over the drinking water source
Is there any occasion where the whole village is cleaned & sanitized compulsorily	No

## FIELD STUDY ON 24TH NOVEMBER, 2010

Field study was conducted at Thirukovilvattam on 18<sup>th</sup> November 2010. Thirukovilvattam GP is located in Mukhathala Block, Kollam District. There are three villages, Thirukovilvattam, Thazhuthala, Kottankara and 23 wards in the GP and the GP is about 15Km from Kollam Junction. The nature of the terrain is sloppy. The total area is 18.66 Sq.Km and population is about 539195 as per 2001 Census.



Thirukovilvattam Gram Panchayat

a) **WATER SUPPLY**

- Source of water is open well, bore well and KWA Scheme in Ward 8 – Kottaikail and it covers 20% of households only.
- Through Beneficiary Group, each household contributed Rs.3000 initially and monthly minimum payment of BPL-Rs.22/HH, SC-Rs.44/HH and general Rs.50/HH.
- Supply of water is weekly once or twice with duration of 5-6 hrs.
- For each household, water meter is fixed and regulatory authorities will collect extra amount if water usage exceeds 10,000 litres.
- Kannannallur River is located here and it is the main source of water for that area.
- Water level depth is low in some area and it goes up to 20-30 feet depth.
- In Anganvadi, for drinking & cooking purposes, water has to be collected from 2Km.
- In ward 10 (Muzhiara Road), there is no scheme and no pipe connection. Water scarcity is prevalent from Kutipuram to Panayil.
- In ward 11 (Panaikkalam), water source is well, which could not be used due to improper maintenance.
- Stream water cannot be used for the drinking purpose due to solid waste dumping & sewage contamination.
- Water is supplied by KWA scheme in Ward 18 to 375 families through public taps. The frequency of water supply is weekly once or twice for 3 to 4 hours. Source of water is Kaniyanthodu. Source of the stream is Kaladai River having many sub streams.

- The source of water is bore well (300-350 feet depth), provided by Rajiv Gandhi Water Supply Scheme. About 125 households are benefited by this scheme, which is functional for the last 7 years.
- Initially Rs.1000/HH was collected as installation amount and Rs.100/ HH monthly.
- 200 families are there in Ward 19 and the source of water is open well. This well was constructed by private party. Local people contributed Rs.10, 000 -15,000 and beneficiary group is maintaining the well. Monthly charge of Rs.200 is collected from each HH.
- In some places, Kerala Water Authority is supplying water by public taps but water supply is not frequent.
- Source of water for Ward 20 is open well having 35 feet depth, 7feet dia. This well was constructed by private party with contribution of Rs.10, 000-15,000 from local people. Now the Panchayat is maintaining the well by collecting Rs.200/HH each month. The open well is located downstream and hence HH in upstream cannot get water frequently. Water supply duration is 4-5hrs daily. Pump house and motor is maintained by beneficiary group. During maintenance and power failure the water supply is stopped and the HH has to rely on other private well.



Well of Ward no. 20

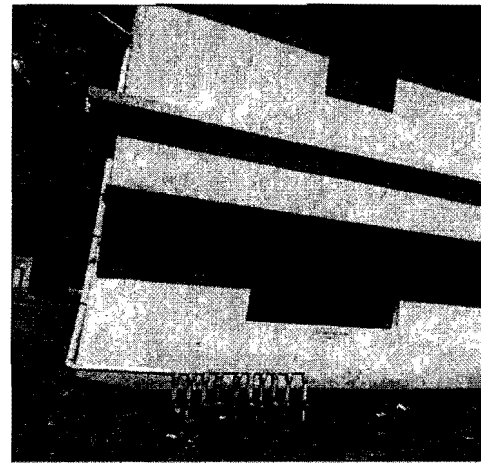

Pump house

- In ward 22 (Vettilathalam), though KWA Scheme is available, water from bore well is used as source and the pump capacity is 15 HP.
- Distribution network for public taps is under process in some areas.
- In Ward 23 (Chenthapur) water source is bore well. From bore well, water is pumped to the overhead tank and supplied to HH. Each HH pay Rs. 45 – 60 / month.

**b) WATER QUALITY**

- In ward no.19, dairy and gum industries release waste water in to the stream, which changes the physical parameters of water like odour and colour.

- Due to improper sewerage and solid waste management system, the Kaniyanthodu is polluted and water is not even used for washing of cloths.

**c) SOLID WASTE MANAGEMENT**

- Market is located in Kottaikail ward. There is no proper disposal facility for the waste generated from market. Bio Waste Treatment Plant was constructed by Bio Tech Company. But presently, the plant is not working and wastes are stored in open places, creating odour problem.
- Solid waste generated from the industries, are dumped in open area and meat wastes are dumped near households.
- Domestic waste is dumped into the open place and sometimes the waste is burnt.
- There is no dustbin for waste collection.



**Solid waste dumping in market**

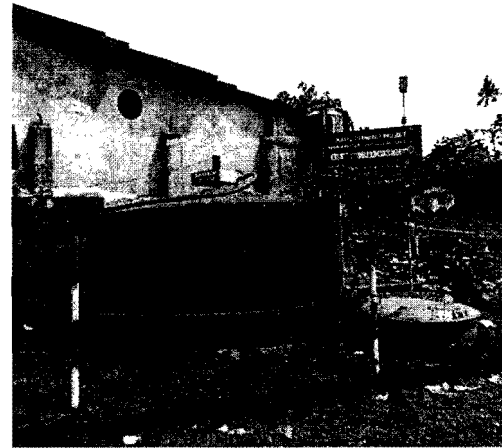

**Bio Waste Treatment Plant**



**Domestic Waste**



**Burning of Waste**

**d) ENVIRONMENTAL SANITATION**

- 95% households have proper sanitation facility.
- In each HH, ISL is provided with leachate pit of 20 to 30 feet depth.
- There is no separate sewerage system.
- Sewage is disposed to nearby canal.



ISL

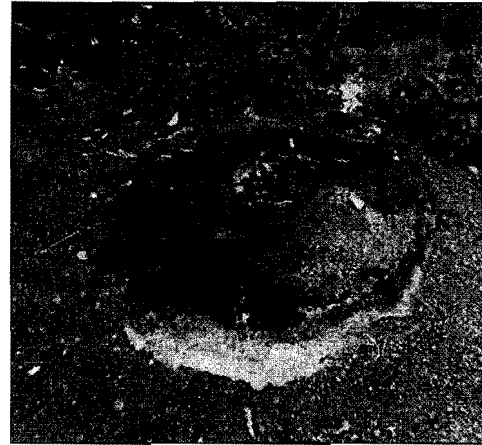

Leachate pit

**e) HEALTH & PERSONAL HYGIENE**

- During rainy season ASHA workers provide bleaching powder to individual HH having wells.
- They also conduct health camp and awareness camp.

**FOCUSED GROUP DISCUSSION HELD ON 19.11.2010 AT  
THIRUKOVILVATTAM**

Focused Group Discussion was conducted on 19.11.2010 at Thirukovilvattam GP, of Mukhathala Block, Kollam District. In FGD, we mainly discussed about problems related to drinking water supply, quality of water, sanitation and solid waste disposal. President, ward members, housewives, anganwadi teachers, school teachers and representatives from local NGO's actively participated in the FGD.

- A. Water supply from Kerala Water Authority is weekly once or twice and this is not enough to suffice the demand.
- B. The Bio Waste Treatment Plant is currently not working and solid wastes dumped are creating odour problem. Suggestion was given to maintain the existing treatment plant.
- C. Due to location of water source downstream, HH in upstream face problem in receiving water.

- D. Since distribution system is through cement pipelines, water will not be available in some places due to leaks/ breakage.
- E. As more agricultural land is converted into residential places, the ground water table is declining.
- F. Ward Number 23 (Chethapur) does not have any scheme and the HH, suggested providing them with one scheme.
- G. Water scarcity is high in summer and hence people have to travel long distances to collect water.
- H. HH suggested rain water harvesting system in every household.
- I. They are ready to accept new water supply scheme and Panchayat is also ready to give land and pay 10%.
- J. People in the GP are economically well doing, more NRI are available and hence are willing to form BG and ready to give 15% share.
- K. Panchayat has provided 1 cent land to dig the open well to KWA. But the scheme was not taken up.

**REPORT 4 EZHUPUNNA**
**VILLAGE SURVEY FORMAT**

<b>Identification</b>	
Name of the District	Alappuzha
Name of the Block	Pattanakkad
Name of the Gram Panchayat	Ezhupunna
Name of the Villages	Ezhupunna and Eramalur
Terrain	Plain
Area in Acres	14.08 Sq.kms
Population	24974 as per 2001 census
Distance from the Gram Panchayat	35 kms from Alappuzha
Depth of water table (Location wise)	3 to 16 mbgl
<b>Water Supply</b>	
Type of Scheme	Kerala Water Authority Scheme, Socio Economic Scheme and JBIC scheme
Source of Water	Bore Well/Canal/ Tank / Pond
Is the well open or covered	Open
Whether the well is Sanitized	No
Source of water in summer	Pond and bore wells
Type of distribution network	Street pipeline
How drinking water is met in coastal area?	Through pipeline
Main source of drinking water	Panchayat Tap
Is there any treatment in case of open well?	Yes
If yes, what treatment is followed?	Chlorination
How many households are boiling water & drinking?	About 70% of House holds
Whether water is boiled or only heated	Boiled
How is the cost aspect maintained for treatment?	O&M cost is borne by KWA
What is the village institutional arrangement for drinking water treatment? Who does the treatment, how often and is it working well?	There is no village institutional arrangement for drinking water. Only chlorination is done by Panchayat.
Handling of drinking water	2. Cover 3. Pot or tank with tap
Supply Duration	From 1 Hrs to 4 Hrs
Supply Frequency	Daily/ Once in a week
Number of	1. Wells -70      4. Tap 2. Tanks -3 3. Hand Pump
Storage Capacity	5000 liters by Socio Economic Scheme

Depth of the aquifer (if it is ground water)	100 -150 m
Is there decline in ground water level	
Summer	Yes
Winter	No
Is there any maintenance shut down if the source from a canal	No
Cost for the Water Supply/HH	Rs. 45/Month
Annual O & M expenditure	-
Repair and Maintenance	Local People or Panchayat
Power	KSEB
Whether Technical support is given for O & M?	No
What type of support?	-
Is there is any Rain water Harvesting Scheme	There is no rain water harvesting scheme. But rain water harvesting tank is constructed in most of the houses.
Is there any conflict between villages for water?	No
<b>Water Quality</b>	
Quality Perception	1. Muddy 2. Salty 3. Bacterial 4. Heavy Metals or pesticide
Surface water quality in the time of low level flow	Bad
How often the water quality is checked?	Others
Any records maintained for water quality?	No records are maintained for water quality
Quality Parameter (Specify parameter and value in ppm)	-
Treatment	Yes
Type of Treatment	1. Chlorination
Type of Storage	OHT
<b>Environmental Sanitation</b>	
Nature of Defecation	1. Individual Sanitary latrine(ISL) 2. Open
Number of ISL	-
ISL Coverage (% of Households)	70%
No. of Public latrines	-
Whether the latrine is conversion of leach pit to shallow two pit or new	New leachate pit
How sanitation is managed in coastal areas & hills?	Sanitation is not managed properly in coastal areas.
Is your ISL/Public Latrine connected to	Leachate pit
How often and what process is followed	-



to empty the pits and tanks?	
Where other people go for defecation	Near the Water Resource
Is there any wastewater body	Yes/No
Is there any drinking water source near the wastewater body	No
Septic tank/Leachate pit waste disposal	Outside Village    Other (Specify)
Use of waste as Manure	No
Presence of Sewerage connection	No
Sewerage Coverage (% of households)	-
Sewage Treatment	No
Where Sewerage is disposed finally	1. Irrigation Canal    2. Pond
<b>Solid Waste</b>	
Where do you dispose solid waste	Inside the village
Where do you dispose fodder waste dung	House backyard
Do you have compost pit for this waste	No
Locations	-
Distance from village (Km)	-
What is done with the waste	1. Burnt    2. Leave it alone
<b>Health &amp; Personal Hygiene</b>	
Health facility	Public Health Centre
Health Staff in Village	1. Govt Doctor
When do you wash hands?	1. Before & after eating 2. After Defecation
What is used for cleaning hands?	Soap
Frequency of bathing	Daily or Once in two days
What kind of hygiene messages do villagers most often hear during programs and campaigns and are these useful?	-
Common diseases	1. Common Cold & fever 2. Skin diseases 3. Diarrhoea
How often is the disease outbreak	Monthly during winter season
Was there a health epidemic due to contaminated water in the past two years?	No
<b>Awareness</b>	
Awareness programs regarding water & sanitation taken up?	Yes, It is conducted by ASHA and public health centre and village Panchayat
How you protect drinking water sources?	There is no protection over the drinking water source
Is there any occasion where the whole village is cleaned & sanitized compulsorily	No

**FIELD STUDY ON 26 NOVEMBER, 2010**

Field study was conducted at Ezhupunna GP on 26th November, 2010. The GP is located in Pattanakkad Block, Alappuzha District. The total area of GP is 14.08 Sq.Km. As per 2001 census, the population is 24974. The GP has two villages, Eramalur and Ezhupunna. There are 16 wards in the GP.

**a) Source of Water**

- Common tap water, wells and ponds are the main sources of drinking water. There are about 70 common wells located in the GP.
- Socio Economic scheme and JBIC water supply scheme are the two existing water supply schemes in the GP. From Socio economic scheme, an overhead tank of capacity 5000 L has been constructed in market area and water is supplied to the households from the tank.
- Due to poor maintenance of the taps and pipelines, most of the HH are facing problem in getting water. Water supplied by KWA scheme is not sufficient to meet the demand and people are collecting water from nearby ponds and wells.
- In Vadakkakath ward, ponds are the main source of water. HH using the pond water are affected by skin diseases.
- In Thottapalli temple, water is supplied by Socio Economic scheme. The quality of the water is good.
- In some wards, HH buy water from private parties.
- There are many ponds and lakes in the GP which has potable.
- A fish processing industry located in the GP discharges waste water directly into the lake.

**b) Water Quality**

- Hardness and salinity are the two main problems in drinking water.
- The water is brown in colour and has a foul smell.

**c) Rain Water Harvesting**

- Rain water harvesting structures are constructed in 10 % of households.
- During rainy season, people collect rain water and use for drinking.

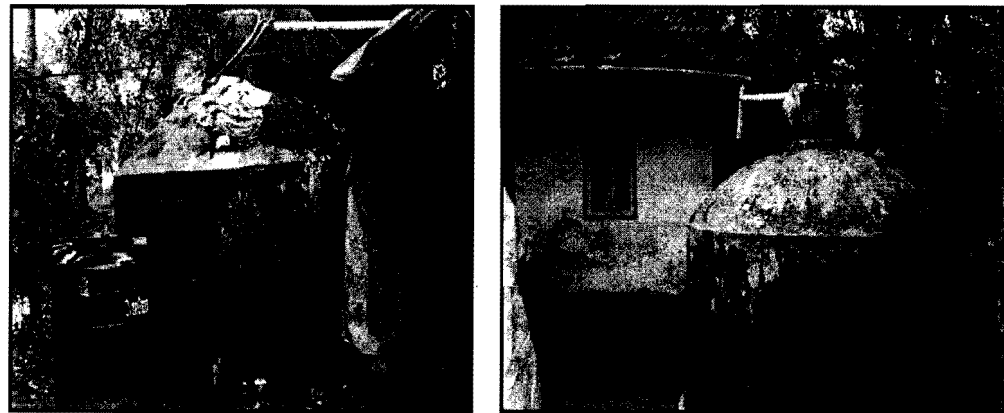

**Rain Water Harvesting System**

*d) Sanitation*

- Only 2 % of the houses have proper sanitation facility (two pit latrines).
- Open defecation is in practice in rest of the areas.



Latrine in Ezhupunna

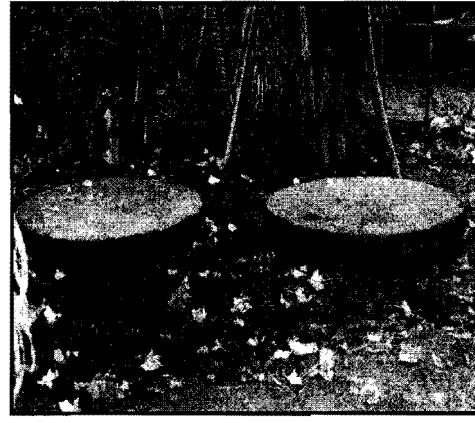

Overflowing Leachate pit

*e) Solid Waste*

- Solid waste generated from the households is disposed into canal, ponds and lakes. There is no proper solid waste collection and disposal system in the village.
- People are dumping waste in their backyards.

*f) Sewage Disposal*

- There is no separate sewerage system.
- Sewage is discharged directly to the nearby canal and ponds leading to contamination.



Sewage Disposal

*g) Health & Personal Hygiene*

- Public Health Centre, ayurveda hospital and homeo hospitals are found in the GP.

- Anganvadi teachers also provide training programs regarding health and hygiene.
- Health camps and awareness programs are conducted by local NGO's.
- During rainy season, bleaching powder is provided by Public Health Centre.

**FOCUSED GROUP DISCUSSION HELD ON 27.11.2010 AT EZHUPUNNA GP**

In the FGD, problems related with drinking water supply, quality of water, sanitation and solid waste disposal were discussed. More than 30 people participated in FGD. President, ward members, housewives, anganwadi teachers, school teachers and representatives from local NGO's actively participated in the FGD.

- A. The participants informed that drinking water is available but contains hardness and salt.
- B. Vice president told that socio economic scheme supplies water, but the scheme covers only some of the villages. JBIC water supply scheme is not in operation due to problem within BG.
- C. People residing in ward no.2 suggested cleaning of pond will help them to use the water for washing and bathing, as the water is contaminated by solid waste dumping.
- D. Though Panchayat is providing subsidy for constructing latrines, the amount is not adequate as per the information given by participants.
- E. Suggestion was given to provide common latrines in bus stops and public places.
- F. HH are ready to take up rain water harvesting structures.
- G. Needankara participants suggested providing individual pipeline connections to each HH.
- H. People are very much aware about solid waste management. Participants enquired about solid waste management facility and are willing to pay the maintenance cost for MSW facility.



**Focused Group Discussion**

**REPORT 5 RAMANAKARY  
VILLAGE SURVEY FORMAT**

<b>Identification</b>	
Name of the District	Alappuzha
Name of the Block	Velliyanad
Name of the Gram Panchayat	Ramankary
Name of the Villages	Ramankary
Terrain	Plain
Area in Acres	16.17 Sq.kms
Population	13840
Distance from the Gram Panchayat	20 Kms from Alappuzha
Depth of water table (Location wise)	3 to 16 mbgl
<b>Water Supply</b>	
Type of Scheme	Kerala Water Authority Scheme
Source of Water	Bore Well/Canal/ Tank / Pond
Is the well open or covered	Open
Whether the well is Sanitized	No
Source of water in summer	Ponds and bore well
Type of distribution network	Street pipeline
How drinking water is met in coastal area?	Through pipeline
Main source of drinking water	Panchayat Tap
Is there any treatment in case of open well?	Yes
If yes, what treatment is followed?	Chlorination
How many households are boiling water & drinking?	About 70% of House holds
Whether water is boiled or only heated	Boiled
How is the cost aspect maintained for treatment?	KWA is charging Rs.42/10 KLD for supplying water to public. The treatment cost maintained in this way.
What is the village institutional arrangement for drinking water treatment? Who does the treatment, how often and is it working well?	There is no village institutional arrangement for drinking water. Only chlorination is done by KWA
Handling of drinking water	1. Cover 2. Pot or tank with tap
Supply Duration	From 1 Hrs to 5 Hrs
Supply Frequency	Daily/ Once in 10 Days
Number of	1. Well 2. Tanks -1 3. Hand Pump 4. Tube well 5. Tap
Storage Capacity	2.50 lakhs litres

Depth of the aquifer (if it is ground water)	100 -150 m
Is there decline in ground water level Summer Winter	Yes No
Is there any maintenance shut down if the source from a canal	Yes
Cost for the Water Supply/HH	Rs 42/10KLD
Annual O & M expenditure	-
Repair and Maintenance	Kerala Water Authority or Panchayat
Power	KSEB
Whether Technical support is given for O & M?	No
What type of support?	-
Is there is any Rain water Harvesting Scheme	There is no rain water harvesting scheme. But rain water harvesting tank is constructed in some of the houses.
Is there any conflict between villages for water?	No
<b>Water Quality</b>	
Quality Perception	1. Muddy 2. Salty 3. Bacterial 4. Heavy Metals or pesticide
Surface water quality in the time of low level flow	Bad
How often the water quality is checked?	Others
Any records maintained for water quality?	No records are maintained for water quality
Quality Parameter (Specify parameter and value in ppm)	-
Treatment	Yes
Type of Treatment	1. Chlorination
Type of Storage	OHT
<b>Environmental Sanitation</b>	
Nature of Defecation	1. Individual Sanitary latrine(ISL) 2. Open
Number of ISL	-
ISL Coverage (% of Households)	70%
No. of Public latrines	-
Whether the latrine is conversion of leach pit to shallow two pit or new	
How sanitation is managed in coastal areas & hills?	Sanitation is not managed properly in coastal area
Is your ISL/Public Latrine connected to	Leachate pit
How often and what process is followed to empty the pits and tanks?	

Where other people go for defecation	In the field, Near the Water Resource
Is there any wastewater body	Yes/No
Is there any drinking water source near the wastewater body	No
Septic tank/Leachate pit waste disposal	1. Outside Village   2. Other (Specify)
Use of waste as Manure	No
Presence of Sewerage connection	No
Sewerage Coverage (% of households)	
Sewage Treatment	No
Where Sewerage is disposed finally	1. Irrigation Canal   2. Pond
<b>Solid Waste</b>	
Where do you dispose solid waste	Inside the village
Where do you dispose fodder waste dung	House backyard
Do you have compost pit for this waste	No
Locations	-
Distance from village (Km)	-
What is done with the waste	1. Burnt   2. Leave it alone
<b>Health &amp; Personal Hygiene</b>	
Health facility	Public Health Centre
Health Staff in Village	1. Govt Doctor
When do you wash hands?	1. Before & after eating 2. After Defecation
What is used for cleaning hands?	Soap
Frequency of bathing	Once in two days
What kind of hygiene messages do villagers most often hear during programs and campaigns and are these useful?	-
Common diseases	1. Common Cold & fever 2. Typhoid 3. Diarrhoea
How often is the disease outbreak	Monthly during winter season
Was there a health epidemic due to contaminated water in the past two years?	No
<b>Awareness</b>	
Awareness programs regarding water & sanitation taken up?	Yes, It is conducted by ASHA and public health centre and village Panchayat
How you protect drinking water sources?	There is no protection over the drinking water source
Is there any occasion where the whole village is cleaned & sanitized compulsorily	No

**FIELD STUDY ON 24.11.2010**

Field study was conducted at Ramankary GP on 24 November, 2010. The GP is located in Velliyanad Block, Alappuzha District. The total area is 16.17 Sq.Kms. As per 2001 census, the population is 13840. The GP has two villages Edathua and Ramankary. Total number of wards is 13.

**a) SOURCE OF WATER**

- Wells, lakes and ponds are the main sources of drinking water.
- Kerala Water Authority Scheme is the existing water supply scheme in the GP. From Thiruvulla station, water comes to Kedangara substation and pumped to the overhead tank in Pallikoottuma located 5 km away from Kedangara.
- The capacity of the overhead tank is 2.50 lakhs litres. From the overhead tank, water is supplied through pipeline to Ramankary. Each house hold has to pay Rs.42 for 10 KLD of water to KWA. The frequency of water supply is once a week.
- In Ramankary, there is no pump house. New pump house is on commissioning stage.
- In Mampuzhakary thekke, people are collecting water from nearby areas by auto. For auto, they have to pay Rs.50 which can carry only 35 litres of water.
- In Mampuzhakary kizhake, there are about 325 families. KWA scheme common tap is seen. But it is not in use.
- Most of the villages are not getting water because the tap and pipelines are not maintained properly. Water which is supplied by KWA scheme is not sufficient to meet the demand; so the people are collecting water from nearby ponds and wells.

**b) WATER QUALITY**

- Quality of the pond and lake water is very poor.
- Water is contaminated by pesticides. People using the water for washing and bathing are affected by skin diseases.
- Salinity problem is seen in back waters.
- The color of the water is brown and cannot be used for drinking purpose.
- The surface water quality is poor due to the eutrophication.



Water Quality



**c) RAIN WATER HARVESTING**

- Rain water harvesting system provided in school and Anganvadi is in working condition.
- In rainy season, people collect rain water in drums by using polythene sheet and use it for drinking.

**Simple form of Rainwater Harvesting****d) SOLID WASTE**

- Solid waste generated from HH is disposed in nearby ponds and lakes.
- There is no proper solid waste collection and disposal system in the village.

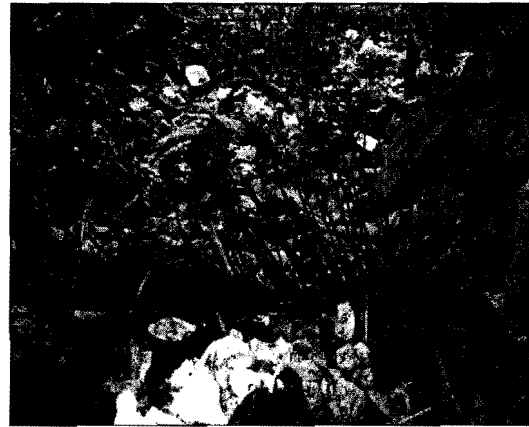
**Solid Waste Disposal****e) SANITATION**

- Only some houses have proper sanitation facility with two pit latrines.
- Open defecation is very common.

**f) SEWAGE DISPOSAL**

- There is no separate sewerage system.
- Sewage is discharged to the nearby canal thereby polluting the canal.



Sewage Disposal into the Streams

**g) HEALTH & PERSONAL HYGIENE**

- People are affected by diseases like diarrhea, viral fever and skin diseases.
- The volunteers from ASHA are conducting awareness program regarding personal hygiene in schools and ward members.
- Panchayat is providing bleaching powder for disinfection.

**FOCUSED GROUP DISCUSSION HELD ON 25.11.2010 AT RAMANAKARY**

In FGD, problems related with drinking water supply, quality of water, sanitation and solid waste disposal were discussed. More than 100 members actively participated in FGD. President, ward members, housewives, anganvadi teachers, school teachers and representatives from local NGOs participated in the FGD and gave their comments.

- A. The participants said that, though water availability is plenty, contamination by pesticides used in paddy fields make it unusable.
- B. The school head master suggested providing latrines and rain water harvesting system in schools, which will improve the sanitation and solve the problem of water scarcity.
- C. The participants from the ASHA suggested providing some remedy to canals as they are affected by pollution.
- D. One of the ward members suggested providing biogas plant, as they can use cow dung in the biogas plant, which is available in plenty.
- E. The people informed that pond in Orikkari is used only for bathing and washing purposes.
- F. The participants suggested providing common latrines in each ward.



**Focused Group Discussion**

- G. The people informed that for the past 10 years, they are getting water only from nearby ponds which is not potable. Drinking water from these ponds, affect their health, causing diarrhoea and viral fever.
- H. People are very much interested in this project and are also ready to pay the 10% maintenance cost.

**REPORT 6 PAMPAKUDA**
**VILLAGE SURVEY FORMAT**

<b>Identification</b>	
Name of the District	Ernakulam
Name of the Block	Pampakuda
Name of the Gram Panchayat	Pampakuda
Name of the Villages	Memmury and Onakoor
Terrain	Sloping
Area in Acres	30.09 Sq.Kms
Population	17,324
Distance from the Gram Panchayat	3.5 Km
Depth of water table (Location wise)	10 mbgl
<b>Water Supply</b>	
Type of Scheme	Kerala Water Authority Scheme and Perincharakudi scheme
Source of Water	Bore Well/Canal/ Tank / Pond
Is the well open or covered	Well is covered with net
Whether the well is Sanitized	Yes, Panchayat will provide chlorine powder for sanitizing the well water
Source of water in summer	Canal water will be the source of water in summer and people will get water from some other private wells.
Type of distribution network	Street pipelines
How drinking water is met in coastal area?	Not applicable
Main source of drinking water	1. Private Tap 2. Panchayat Tap 3. Common well/Individual Open well
Is there any treatment in case of open well?	Yes
If yes, what treatment is followed?	1. Boiling 2. Chlorination
How many households are boiling water & drinking?	85 % of houses are using boiled water for drinking
Whether water is boiled or only heated	Boiled
How is the cost aspect maintained for treatment?	Bleaching powder is supplied by KWA, Panchayat
What is the village institutional arrangement for drinking water treatment? Who does the treatment, how often and is it working well?	No
Handling of drinking water	1. Cover 2. Pot or tank with tap
Supply Duration	From 3 Hrs 4 Hrs
Supply Frequency	Daily/ Once in 4 Days



Number of	1. Well - 14 2. Tanks - 4 3. Hand Pump	4. Tube well - 3 5. Tap - 40
Storage Capacity	5000 litres by KWA scheme	
Depth of the aquifer (if it is ground water)	100 meters	
Is there decline in ground water level Summer Winter	Yes No	
Is there any maintenance shut down if the source from a canal	No	
Cost for the Water Supply	Rs. 900 – 1000/ lorry	
Annual O & M expenditure	O&M expenditure borne by contractor	
Repair and Maintenance	By contractor	
Power	KSEB	
Whether Technical support is given for O & M?	No	
What type of support?	No	
Is there is any Rain water Harvesting Scheme	Rain water harvesting scheme is available in Olikkathandel colony	
Is there any conflict between villages for water?	No	
<b>Water Quality</b>		
Quality Perception	1. Muddy 2. Salty	3. Bacterial or Chemical 4. Iron content
Surface water quality in the time of low level flow	Fair	
How often the water quality is checked?	There is no periodical check of water quality	
Any records maintained for water quality?	No	
Quality Parameter (Specify parameter and value in ppm)	No	
Treatment	Yes	
Type of Treatment	Chlorination	
Type of Storage	OHT	
<b>Environmental Sanitation</b>		
Nature of Defecation	1. Individual Sanitary latrine(ISL) 2. Open	
Number of ISL		
ISL Coverage (% of Households)	60 %	
No. of Public latrines	No	
Whether the latrine is conversion of leach pit to shallow two pit or new	No	
How sanitation is managed in coastal areas & hills?	Not applicable	
Is your ISL/Public Latrine connected to	Leachate pit	
How often and what process is followed	Once the Leachate pit is full, it is closed.	

to empty the pits and tanks?	
Where other people go for defecation	In the field/ Near the Water Resource
Is there any wastewater body	Yes
Is there any drinking water source near the wastewater body	No
Septic tank/Leachate pit waste disposal	They close the pit
Use of waste as Manure	No
Presence of Sewerage connection	No
Sewerage Coverage (% of households)	No
Sewage Treatment	No
Where Sewerage is disposed finally	Sewage is disposed in the field
<b>Solid Waste</b>	
Where do you dispose solid waste	In the open area
Where do you dispose fodder waste dung	House backyard
Do you have compost pit for this waste	No
Locations	No
Distance from village (Km)	No
What is done with the waste	Burnt
<b>Health &amp; Personal Hygiene</b>	
Health facility	Public Health Centre
Health Staff in Village	Govt Doctor -2
When do you wash hands?	1. Before & after eating 2. After Defecation
What is used for cleaning hands?	Soap
Frequency of bathing	1. Daily 2. Once in two days
What kind of hygiene messages do villagers most often hear during programs and campaigns and are these useful?	Nil
Common diseases	1. Common Cold & fever 2. Diarrhoea 3. Skin diseases 4. Viral Hepatitis - A
How often is the disease outbreak	Seasonal
Was there a health epidemic due to contaminated water in the past two years?	No
<b>Awareness</b>	
Awareness programs regarding water & sanitation taken up?	Awareness program on sanitation is conducted by Primary health centres
How you protect drinking water sources?	No
Is there any occasion where the whole village is cleaned & sanitized compulsorily	No

**FIELD STUDY ON 14 NOVEMBER, 2010**

Field Study was conducted on 14.11.2010 in Pampakuda GP, Ernakulam District. This GP has two villages Onakoor and Memmury and total no. of wards is 12. The GP is located at the distance of 48 Km from Ernakulam. As per 2001 census, the total population of the GP is about 17,324. The area of the Gram Panchayat is about 30.09 Sq.Km.

**a) SOURCE OF WATER**

- The type of Water Supply Scheme available in the GP is Kerala Water Authority (KWA). The KWA scheme covers only 10% of the population. The remaining population is taking water from well or nearby ponds. The main source of water is from Aruvizkkal- Muduku Thodu and Uzhavoor thodu.
- The source of water for the KWA Scheme is taken from both the Canals and bore well but the quantity is less during summer. Distribution of water through the pipelines is not proper for most of the wards.
- In Piravam there are two bore wells and water is distributed to 13 wards.
- In Kakard there is 1 pump house with the pump capacity of 25HP. The supply of water will be once or twice a week, for 3 to 4 hours.
- In Pulikunna mala there is KWA Scheme, with a tank capacity of 5000 litres. Due to slopy terrain, HH in higher elevation didn't get water and also the pipes are damaged.
- In Pullamphadam (Ward No.13), a water tank is there but not functioning, due to slopy terrain.
- In Chellakathinal mala, there is Perincharakudi Scheme and it covers 50 HH. But water supply is through one public tap and the duration is one day in a week.
- In Nallanikunnur, water is supplied by KWA scheme for 25 households. There are only 2 public taps and water is supplied weekly once by gravity.
- In Muttakul there is no water supply scheme and people are taking water from nearby pond, which is 1.5 Km away.
- In Chennatumala for 40 HH, the Panchayat provided 40 cent land to implement the Harijan water supply scheme but due to high land area and non availability of the ground water, the scheme was cancelled. People in that area get water by paying Rs.900 to Rs.1000 by lorry service.
- HH having well, sell the water to other agencies which in turn supplies water through lorries.

**b) RAIN WATER HARVESTING**

- Rain water harvesting scheme is found in only some HH
- Olikathandel Colony is having rain water harvesting scheme in one house and they are using the water for washing and bathing.

**c) WATER QUALITY**

- The quality of water is mostly good in this area.
- In Piramadomalpara, the HH does not use KWA Scheme water for drinking due to yellowish colour and poor quality. The people use the water for other purpose only.



- Testing of water quality is not done.
- There are many ponds in the GP, but most of them are contaminated.



**Pond Contamination**

**d) SOLID WASTE**

- Dispose of solid waste is done inside the village.
- Dispose of fodder waste and dung is done in backyard and in some HH the dung is used as a combustion material.
- Cow dung is also used as manure.



**Poor Solid Waste Management**

**e) ENVIRONMENTAL SANITATION**

- Only 60% of HH have proper sanitation facility with two pit latrines. Rest of the people use open area and field.
- The ISL is connected with leachate pit only.
- No public latrines are available.



- There is no sewerage connection throughout the GP and the sewage is disposed in open area or nearby pond.

**f) HEALTH & PERSONAL HYGIENE**

- Primary Health Centre is available in the GP and 2 doctors are there for 24 hours.
- The Public Health Department is providing bleaching powder for the households and with the help of Panchayat they are conducting health and awareness program.
- There is no common disease found but some people are affected by cancer.

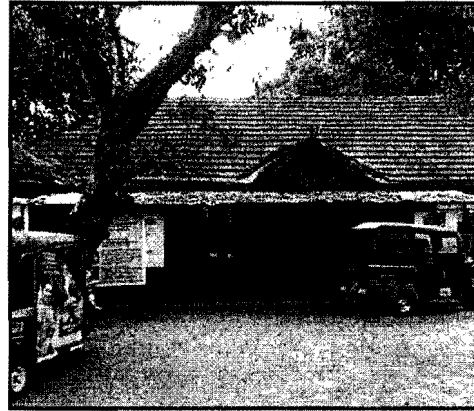

**Public Health Centre**

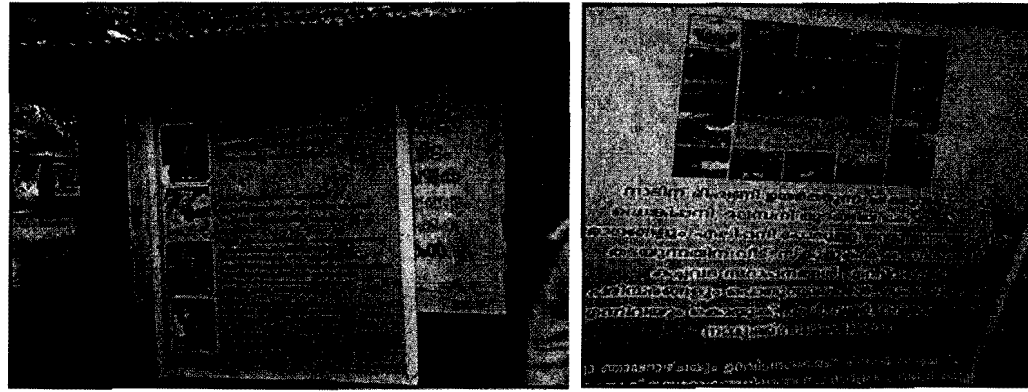

**Public Health Awareness Programmes**

**FOCUSED GROUP DISCUSSION HELD ON 15.11.2010 AT PAMPAKUDA**

Total No. of participants in the FGD are 21. The President, Vice President, ward members, anganvadi teachers, school teachers, women participated in FGD and issues related to water supply, quality of water, sanitation etc were discussed.

- A. During rainy season, silt and clay accumulate in the well, affecting quality of water, clogging impeller of the pump, resulting in pump failure.

- B. There is water scarcity during summer, as the water availability reduces by 25%.
- C. Common wells are available but not in use because of contamination and poor maintenance.



**Poor Maintenance of Well**

- D. People boil canal water for drinking and the drink the well water without boiling.
- E. The vice president addressed about the severity of sanitation problem and contamination of ponds due to poor solid waste management system.
- F. Women participants addressed about traveling long distances (2 Km) for collecting water.
- G. Source of canal water is Kallikadu dam. Since canal water is yellow, HH use the water for purposes other than drinking.
- H. People are willing to accept the new scheme but Panchayat is not willing to pay the 10%, due to poor economic status of the GP.
- I. Participants suggested that disposal of garbage along the roadside and in the vicinity of residential area needs to be addressed.

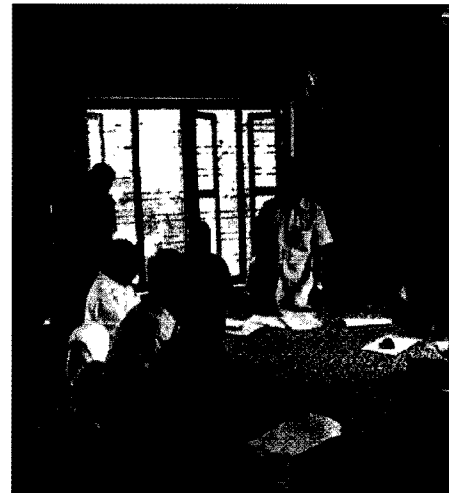
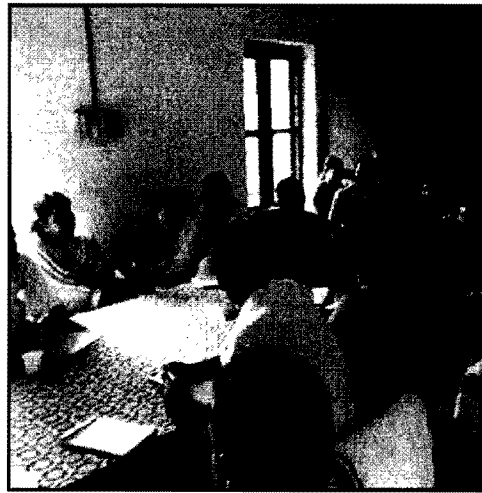

**FGD at Pampakuda**

**REPORT 7 ERIYAD**
**VILLAGE SURVEY FORMAT**

<b>Identification</b>	
Name of the District	Thrissur
Name of the Block	Kodungalur
Name of the Gram Panchayat	Eriyad
Name of the Villages	Eriyad
Terrain	Plain
Area in Acres	
Population	44,863 as per 2001 census
Distance from the Gram Panchayat	38 kms from Thrissur
Depth of water table (Location wise)	20 m
<b>Water Supply</b>	
Type of Scheme	Kerala water Authority
Source of Water	Bore Well, Chalakkudi river
Is the well open or covered	Open
Whether the well is Sanitized	No
Source of water in summer	Less
Type of distribution network	Thorough Panchayat pipeline
How drinking water is met in coastal area?	Drinking water is met by KWA scheme only
Main source of drinking water	1. Panchayat Tap 2. Bore well 3. Public Open Well/Individual Open well
Is there any treatment in case of open well?	Yes
If yes, what treatment is followed?	Chlorination
How many households are boiling water & drinking?	80 %
Whether water is boiled or only heated	Boiled
How is the cost aspect maintained for treatment?	By Gram Panchayat
What is the village institutional arrangement for drinking water treatment? Who does the treatment, how often and is it working well?	No
Handling of drinking water	1. Cover 2. Pot or tank with tap
Supply Duration	From 2 Hrs to 6 Hrs
Supply Frequency	Once in a week/ weekly twice
Number of	1. Bore Well - 15 2. Common well - 7 3. River - 1
Storage Capacity	2 lakhs litres
Depth of the aquifer (if it is ground water)	100 metres
Is there decline in ground water level	
Summer	Yes
Winter	No
Is there any maintenance shut down if the source from a canal	No
Cost for the Water Supply	Rs 60/ Month



Annual O & M expenditure	O & M expenditure is borne by contractor	
Repair and Maintenance	By contractor	
Power	KSEB	
Whether Technical support is given for O & M?	No	
What type of support?	No	
Is there is any Rain Water Harvesting Scheme	No	
Is there any conflict between villages for water?	No	
<b>Water Quality</b>		
Quality Perception	1. Muddy 2. Bacterial	3. Salty 4. Iron content
Surface water quality in the time of low level flow	Fair	
How often the water quality is checked?	There is no periodical checking of water quality	
Any records maintained for water quality?	Nil	
Quality Parameter (Specify parameter and value in ppm)	Nil	
Treatment	No	
Type of Treatment	Chlorination	
Type of Storage	OHT	
<b>Environmental Sanitation</b>		
Nature of Defecation	1. Individual Sanitary latrine(ISL) 2. Open	
Number of ISL		
ISL Coverage (% of Households)	60 %	
No. of Public latrines	No	
Whether the latrine is conversion of leach pit to shallow two pit or new	No	
How sanitation is managed in coastal areas & hills?	Sanitation is not managed properly in coastal area	
Is your ISL/Public Latrine connected to	Leachate pit	
How often and what process is followed to empty the pits and tanks?	Once the Leachate pit is full, they will disposed into the sea	
Where other people go for defecation	In the field/Near the sea	
Is there any wastewater body	No	
Is there any drinking water source near the wastewater body	No	
Septic tank/Leachate pit waste disposal	They disposed into the sea	
Use of waste as Manure	No	
Presence of Sewerage connection	No	
Sewerage Coverage (% of households)	No	
Sewage Treatment	No	
Where Sewerage is disposed finally	Sewage is disposed into the stream and sea	
<b>Solid Waste</b>		
Where do you dispose solid waste	In the open area/ canal/ pond	
Where do you dispose fodder waste dung	House backyard	
Do you have compost pit for this waste	No	
Locations	No	
Distance from village (Km)	Not applicable	

What is done with the waste	Burnt
<b>Health &amp; Personal Hygiene</b>	
Health facility	Public Health Centre
Health Staff in Village	Govt Doctor
When do you wash hands?	1. Before & after eating 2. After Defecation
What is used for cleaning hands?	Soap
Frequency of bathing	1. Daily 2. Once in two days
What kind of hygiene messages do villagers most often hear during programs and campaigns and are these useful?	-
Common diseases	1. Common Cold & fever 2. Diarrhoea 3. Skin diseases
How often is the disease outbreak	Seasonal
Was there a health epidemic due to contaminated water in the past two years?	No
<b>Awareness</b>	
Awareness programs regarding water & sanitation taken up?	Awareness program is conducted by Gram Panchayat and public health centres
How you protect drinking water sources?	Nil
Is there any occasion where the whole village is cleaned & sanitized compulsorily	No

#### FIELD STUDY ON 25NOVEMBER, 2010

Field study was conducted at Eriyad Gram Panchayat on 25 November, 2010. The GP is located at Kodungalur Block, Thrissur District. As per 2001 census, the population is 44863. The GP has 23 wards.

##### a) SOURCE OF WATER

- The source of drinking water is KWA scheme. Water is pumped from Salagudi River and sent to the vaithala pump station. Water is treated here and supplied to the Eriyad Panchayat.
- Water is supplied to each house by Panchayat tap, the frequency is once or twice a week for one to two hours.
- Water from individual bore well is used for bathing and flushing.
- HH collect water whenever available and store in cans.
- Wards located in Coastal areas get saline water and the only source of drinking water is KWA scheme, which is not supplied regularly.
- In Eriyad market the source of water is open well, bore well & KWA scheme. Most of the HH use KWA scheme for drinking purpose. Water is supplied weekly 2 to 3 days.
- One scheme was already implemented 15 years back by Panchayat in Eriyad but not in use for drinking because of more iron content in the water. The Panchayat has decided to revamp the scheme.

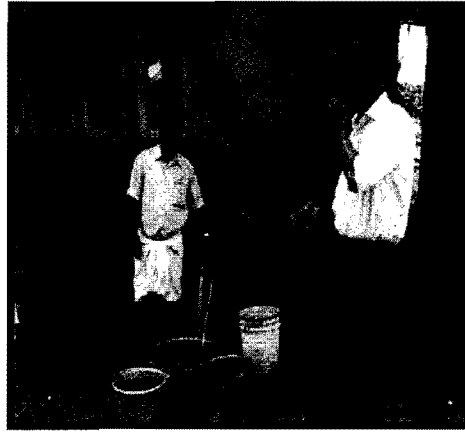

KWA scheme



Water Stored in Cans

**b) WATER QUALITY**

- In coastal areas there is saline water.
- In Eriyad market, iron content is more. So, the water is not fit to drink.

**c) SANITATION**

- Open defecation is very common.
- Some HH have pit latrines. The latrine was constructed by an NGO 10-15 years ago. Initially each HH spent Rs.250
- Some toilets are damaged. Once the pit is full, the waste is emptied into sea.

**d) SOLID WASTE**

- Solid wastes generated from HH are disposed to the canal, ponds and lakes.
- There is no proper solid waste collection and disposal system.
- People are dumping waste in the backyard.

**e) SEWAGE DISPOSAL**

- There is no sewerage system.
- Sewage discharged into streams and contaminates them.



Sewage disposal into the stream

**f) HEALTH & PERSONAL HYGIENE**

- One Public Health Centre is available, which conducts health awareness programs.
- Bleaching powder is also provided by PHC for disinfection.

**FOCUSED GROUP DISCUSSION HELD ON 26.11.2010 AT ERIYAD GP**

In the FGD, problems related with drinking water supply, quality of water, sanitation and solid waste disposal were discussed. Total no. of participants was more than 30.

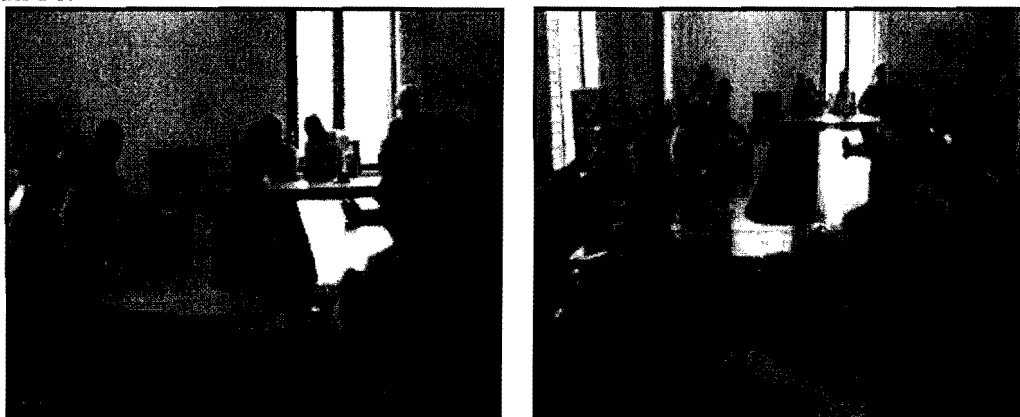

**Focused Group Discussion**

- A. The waste water from HH is discharged into stream and it gets contaminated. Participants suggested revamping of the stream.
- B. Participants expressed 15% B.G contribution to be high.
- C. KWA is constructing a tank of capacity 2-2.5lakh litres. People are of opinion that once the scheme is completed, they will get enough water. Hence, they are not interested in new scheme.
- D. The participants expressed their interest in rainwater harvesting scheme.
- E. Participants expressed that, revamping Seraman pond will provide water for drinking purpose.

**REPORT 8 AGALI**  
**VILLAGE SURVEY FORMAT**

<b>Identification</b>	
Name of the District	Palakkad
Name of the Block	Alathur
Name of the Gram Panchayat	Agali
Name of the Villages	
Terrain	Plain and Slopy
Area in Acres	139 Sq.kms
Population	32,738
Distance from the Gram Panchayat	5 km
Depth of water table (Location wise)	Pre monsoon- 4 to 11 mbgl Post monsoon- 3 to 8 mbgl
<b>Water Supply</b>	
Type of Scheme	Iswhara Shudha Jala Vitharana Samithi, Attapady Social Service Organization and Jalanidhi
Source of Water	Bore Well/ River/ Canal
Is the well open or covered	Well is covered with net
Whether the well is Sanitized	Yes, Panchayat will provide chlorine powder for sanitizing the well water
Source of water in summer	Open well is the source of water in summer and people will get water from some other private wells.
Type of distribution network	The water is distributed by street pipelines
How drinking water is met in coastal area?	There is no coastal area in this district
Main source of drinking water	1. Panchayat Tap 2. Public Open Well/Individual Open well
Is there any treatment in case of open well?	Yes
If yes, what treatment is followed?	1. Boiling 2. Chlorination
How many households are boiling water & drinking?	70 % of houses are using boiled water for drinking
Whether water is boiled or only heated	Boiled
How is the cost aspect maintained for treatment?	The implementing agency is collecting the money for supplying of drinking water. This money is used for treatment of water and maintenance
What is the village institutional arrangement for drinking water treatment? Who does the treatment, how often and is it working well?	There is no institutional arrangement for drinking water treatment. Local NGO's and Panchayat is treated the drinking water such as chlorination
Handling of drinking water	1. Cover 2. Pot or tank with tap
Supply Duration	From 2 Hrs 6 Hrs
Supply Frequency	Daily/ Once in 6 Days
Number of	1. Well -5      4. Tube well 2. Tanks      5. Tap 3. Hand Pump
Storage Capacity	20,000 litres at Kavundikkal
Depth of the aquifer (if it is ground water)	Below 100 meters





Is there decline in ground water level Summer	Yes						
Winter	No						
Is there any maintenance shut down if the source from a canal	No						
Cost for the Water Supply	Rs 60- 100 / Month						
Annual O & M expenditure	Nil						
Repair and Maintenance	Repair & maintenance is carried out by contractor						
Power	KSEB						
Whether Technical support is given for O & M?	No						
What type of support?	Nil						
Is there is any Rain water Harvesting Scheme	Rain water harvesting system was provided by <b>AHADS</b> (Attapady Hills Area Development Society)						
Is there any conflict between villages for water?	Yes, the village which is located in higher altitude does not receive enough water and a house which is located in low lying area receives more water. So, there is a conflict between two villages for water.						
<b>Water Quality</b>							
Quality Perception	<table border="0"> <tr> <td>1. Muddy</td> <td>3. Fluoride</td> </tr> <tr> <td>2. Smell</td> <td>4. Bacterial or Chemical</td> </tr> <tr> <td></td> <td>5. Iron content</td> </tr> </table>	1. Muddy	3. Fluoride	2. Smell	4. Bacterial or Chemical		5. Iron content
1. Muddy	3. Fluoride						
2. Smell	4. Bacterial or Chemical						
	5. Iron content						
Surface water quality in the time of low level flow	Fair						
How often the water quality is checked?	There is no periodic testing						
Any records maintained for water quality?	No						
Quality Parameter (Specify parameter and value in ppm)	Nil						
Treatment	Yes						
Type of Treatment	Chlorination						
Type of Storage	OHT						
<b>Environmental Sanitation</b>							
Nature of Defecation	<table border="0"> <tr> <td>1. Individual Sanitary latrine(ISL)</td> </tr> <tr> <td>2. Open</td> </tr> </table>	1. Individual Sanitary latrine(ISL)	2. Open				
1. Individual Sanitary latrine(ISL)							
2. Open							
Number of ISL	48						
ISL Coverage (% of Households)	55%						
No. of Public latrines	Nil						
Whether the latrine is conversion of leach pit to shallow two pit or new	Leachate pit						
How sanitation is managed in coastal areas & hills?	There is no proper sanitation facilities						
Is your ISL/Public Latrine connected to	Leachate pit						
How often and what process is followed to empty the pits and tanks?	The night soil is collected by private agencies.						
Where other people go for defecation	In the field/ Forest						
Is there any wastewater body	No						
Is there any drinking water source near the wastewater body	No						
Septic tank/Leachate pit waste disposal	Near Fields						

Use of waste as Manure	No
Presence of Sewerage connection	No
Sewerage Coverage (% of households)	Nil
Sewage Treatment	No
Where Sewerage is disposed finally	Open area
<b>Solid Waste</b>	
Where do you dispose solid waste	Outside the village
Where do you dispose fodder waste dung	House backyard
Do you have compost pit for this waste	No
Locations	-
Distance from village (Km)	-
What is done with the waste	1. Burnt 2. Leave it alone
<b>Health &amp; Personal Hygiene</b>	
Health facility	Public Health Centre
Health Staff in Village	1. Govt. Doctor
When do you wash hands?	1. Before & after eating 2. After Defecation
What is used for cleaning hands?	Soap
Frequency of bathing	Daily
What kind of hygiene messages do villagers most often hear during programs and campaigns and are these useful?	-
Common diseases	1. Common Cold & fever 2. Diarrhoea 3. Skin diseases
How often is the disease outbreak	---
Was there a health epidemic due to contaminated water in the past two years?	----
<b>Awareness</b>	
Awareness programs regarding water & sanitation taken up?	Awareness program on sanitation is conducted by AHADS
How you protect drinking water sources?	Through covering the tank
Is there any occasion where the whole village is cleaned & sanitized compulsorily	No

#### FIELD STUDY ON 11 & 12 OCTOBER, 2010

Field Study was conducted at Agali GP on 11 & 12 October 2010. The GP is located in Attapady Block, Palakkad District. Attapady is the only tribal Block in Kerala. As per 2001 census, the total population of the Block is 66,171. The general category population constitutes 55 % of the population and the ST&SC comprise 45%. Among the Scheduled Tribes, there are Kurumbas, Mudugas and Irulas.

#### a) SOURCE OF WATER

- The source of water is open well in Kavundikkal. Jalanidhi -1 is implemented here in 2003 and running successfully till date. Totally 68 families are benefitted from this source. Initially there were 58 families and later 10 families were added. Water is stored in overhead tank of capacity 20,000 litres. There is a water shortage during summer. Each



family pays Rs.60/- month to the committee. The project was implemented by ASSO (Attapady Social Service Organization)

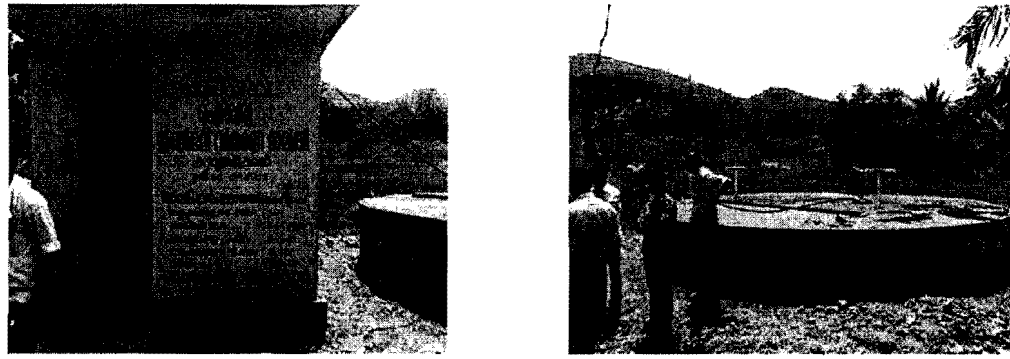

Kavundikkal Jalanidhi-1 scheme

- The source of water in Mettuvizhi Hamlet is well for drinking purposes. The well is located near river basin. This project was implemented by Jalanidhi in 2005 and water was available till 2007. This scheme is non functional due to poor maintenance of motor and pumps.

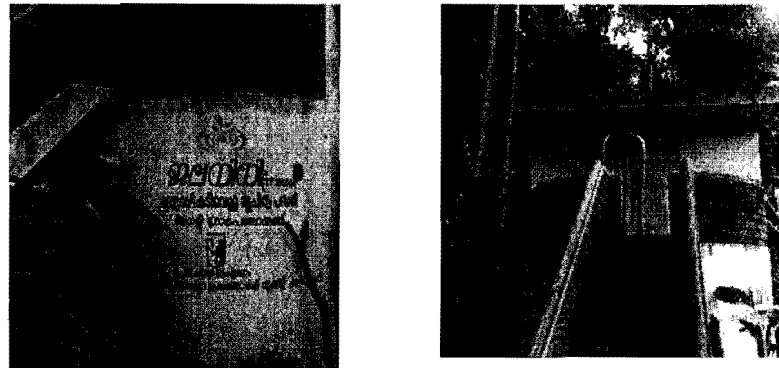

Mettuvizhi Jalanidhi-1 Scheme

- Now the HH depend on other sources for water like river, small ponds etc.
- 35 families live separately in the Hamlet. These HH use private well as a source for water. This facility was arranged by AHADS (Attapady Hills Area Development Society). The capacity of the private well is 1708 m<sup>3</sup> (8.5 m depth and 9 m dia). The well water is pumped to tank and circulated to 35 HH by pipe.

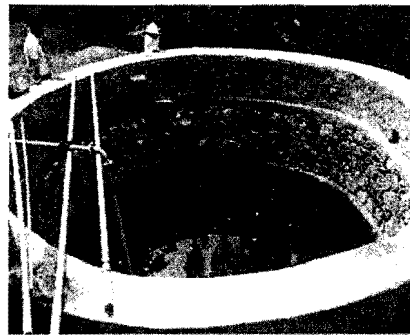

Private well by AHADS

- Sarangamalai is located in Mettuvizhi Halmet. Totally 25 HH are getting water from Jalanidhi-1. The tank is located in Sarangamalai and water is distributed from there.
- People also bring water from a private well used for cultivation which is 600m to 1km distance from their residence.
- Since water is of great demand, people sell their domestic animals and hence the area is economically affected
- There are 100 families in Guddyaoor. The source of water is open well and the scheme was implemented by ASSO. Motor is driven by diesel engine and as the fuel cost is very high, people use the motor weekly once. Capacity of well 700m<sup>3</sup>(5m dia, 5m depth) and tank storage capacity is 15,000 litres. During summer water is of great demand and hence they bring water from private well located at a distance of 500m-750m.

**b) RAIN WATER HARVESTING**

- Rain water harvesting System is constructed in Anganvadi and Government Tribal School at Kavundikkal. This system is in working condition. The Rain Water Harvesting System was developed by AHADS.
- The Rain Water harvesting tank in Mettuvizhi Hamlet has a capacity of 15,000 litres. This water is used for drinking and other purposes. It was developed by AHADS.



RWH facility at Mettuvizhi

**c) SOLID WASTE**

- Domestic waste is stored inside the village, which is collected once in 10 days by Panchayat.
- Cow dung is used for agricultural purpose as manure.

**d) SANITATION**

- Only 70% of the HH have proper sanitation facility with two pit latrines.
- Open defecation is common.
- Private parties collect waste from septic tank and the charge for collecting the waste varies from Rs.3000-4500/-

**e) SEWAGE DISPOSAL**

- There is no separate sewerage system.
- Sewage is disposed to open area.

**FOCUSED GROUP DISCUSSION HELD ON 13.10.2010 AT KAVUNDIKKAL**

Total participants were 29. Women participants were also seen in the FGD. Issues related to water supply, quality of water, sanitation etc. was discussed.

- A. Water supply system at Mattuvazhi failed due to poor maintenance of pumps. Due to prolonged failure beneficiaries are unwilling to pay monthly contribution towards operation and maintenance pump, pumping main energy charges, operator salary etc.
- B. Participants expressed that during rainy season, flood with silt and clay accumulate in the well, affecting quality of water, besides clogging impeller of the pump, resulting in pump failure.
- C. Lack of interest among the beneficiaries to maintain water supply system because of improper accounting system of executive committee of the Beneficiary Group.
- D. Electricity to the water supply system is supplied through a transformer and the supply has also been extended to other users resulting in failure of transformer on account of over load. In spite of their repeated request with the concerned official, there was no response from the electrical department.
- E. Lack of cohesiveness among beneficiaries and local political interference does not allow any further steps to be taken.
- F. Beneficiaries of Kavundikkal expressed satisfaction on water distribution system in winter and summer season, through there is reduction in per capita water supply during summer. There is a perfect understanding among the community in rendering co-operation regarding operation and maintenance of the water supply system without any financial constraints.
- G. Participant expressed that disposal of garbage along the roadside and in the vicinity of residential area needs to be addressed.
- H. Rise in subsidy for contribution of pit latrines was requested by the beneficiaries. Though many of the households were benefited earlier from the subsidy, they have not completed the construction. The community lack awareness and ownership or participation in a government scheme.
- I. Participants expressed that, tribal community may be exempted from paying initial contribution for the demand responsive water supply project.



FGD at Kavundikkal

**REPORT 9 ERUTHENPATHY  
VILLAGE SURVEY FORMAT**

<b>Identification</b>	
Name of the District	Palakkad
Name of the Block	Chittur
Name of the Gram Panchayat	Eruthenpathy
Name of the Villages	
Terrain	1. Sloping 2. Hilly
Area in Acres	36.93 Sq.kms
Population	17,815
Distance from the Gram Panchayat	
Depth of water table (Location wise)	Pre monsoon- 4 to 11 mbgl Post monsoon- 3 to 8 mbgl
<b>Water Supply</b>	
Type of Scheme	Kerala Water Authority
Source of Water	Bore Well/ River/ Tank
Is the well open or covered	Well is covered with net
Whether the well is Sanitized	Yes, Panchayat will provide chlorine powder for disinfection of the well water
Source of water in summer	Open well is the source of water in summer and people will get water from some other private wells.
Type of distribution network	The water is distributed by pipelines
How drinking water is met in coastal area?	There is no coastal area in this district
Main source of drinking water	1. Private Tap 2. Panchayat Tap
Is there any treatment in case of open well?	Yes
If yes, what treatment is followed?	1. Boiling 2. Chlorination
How many households are boiling water & drinking?	70 % of houses are using boiled water for drinking
Whether water is boiled or only heated	1. Boiled
How is the cost aspect maintained for treatment?	The implementing agency is collecting the money for supplying of drinking water. This money is used for treatment of water and maintenance
What is the village institutional arrangement for drinking water treatment? Who does the treatment, how often and is it working well?	There is no institutional arrangement for drinking water treatment. Local NGO's and Panchayat is treated the drinking water such as chlorination
Handling of drinking water	1. Cover 2. Pot or tank with tap
Supply Duration	From 2 Hrs 6 Hrs



Supply Frequency	Weekly once or Once in 2 Days	
Number of	1. Well - 4 2. Tanks - 1 3. Hand Pump - 3	4. Tube well 5. Tap - 25
Storage Capacity	20,000 litres at Kavundikkal	
Depth of the aquifer (if it is ground water)	100 m	
Is there decline in ground water level		
Summer	Yes	
Winter	No	
Is there any maintenance shut down if the source from a canal	No	
Cost for the Water Supply/ HH	Rs 60 / Month	
Annual O & M expenditure	Nil	
Repair and Maintenance	Repair & maintenance is carried out by contractor	
Power	KSEB	
Whether Technical support is given for O & M?	No	
What type of support?	No	
Is there is any Rain water Harvesting Scheme	Rain water harvesting system was provided by <b>AHADS</b> (Attapady Hills Area Development Society) and Panchayat.	
Is there any conflict between villages for water?	Yes, the village which is located in higher altitude does not receive enough water and houses which are located in low lying area receive more water.	
<b>Water Quality</b>		
Quality Perception	1. Muddy 2. Fluoride	3. Bacterial or Chemical 4. Iron content
Surface water quality in the time of low level flow	bad	
How often the water quality is checked?	There is no periodical checking of water quality	
Any records maintained for water quality?	There is no record is maintained for water quality	
Quality Parameter (Specify parameter and value in ppm)	Nil	
Treatment	Yes	
Type of Treatment	Chlorination	
Type of Storage	OHT	
<b>Environmental Sanitation</b>		
Nature of Defecation	1. Individual Sanitary latrine (ISL) 2. Open	
Number of ISL		
ISL Coverage (% of Households)	50%	
No. of Public latrines	No	
Whether the latrine is conversion of leach	There is no conversion	



pit to shallow two pit or new	
How sanitation is managed in coastal areas & hills?	There is no sanitation facility
Is your ISL/Public Latrine connected to	Leachate pit
How often and what process is followed to empty the pits and tanks?	sewage is collected by private parties
Where other people go for defecation	In the field/ Forest
Is there any wastewater body	No
Is there any drinking water source near the wastewater body	No
Septic tank/Leachate pit waste disposal	1. Outside Village   2. Near Fields
Use of waste as Manure	No
Presence of Sewerage connection	No
Sewerage Coverage (% of households)	Nil
Sewage Treatment	Yes/No
Where Sewerage is disposed finally	Discharged in to the field
<b>Solid Waste</b>	
Where do you dispose solid waste	Inside the village
Where do you dispose fodder waste dung	House backyard
Do you have compost pit for this waste	No
Locations	Nil
Distance from village (Km)	Nil
What is done with the waste	Burnt
<b>Health &amp; Personal Hygiene</b>	
Health facility	Public Health Centre
Health Staff in Village	1. Govt Doctor -1
When do you wash hands?	1. Before & after eating 2. After Defecation
What is used for cleaning hands?	Soap
Frequency of bathing	3. Daily 4. Once in two days
What kind of hygiene messages do villagers most often hear during programs and campaigns and are these useful?	Nil
Common diseases	1. Common Cold & fever 2. Typhoid 3. Diarrhoea 4. Viral Hepatitis A
How often is the disease outbreak	
Was there a health epidemic due to contaminated water in the past 2 years?	Typhoid, Chikungunya
<b>Awareness</b>	
Awareness programs regarding water & sanitation taken up?	Awareness program on sanitation is conducted by AHADS
How you protect drinking water sources?	Through covering the tank
Is there any occasion where the whole village is cleaned & sanitized compulsorily	No



FIELD STUDY ON 07 DECEMBER, 2010

The GP is located at Chittur Block in Palakkad District. Total area of the GP is 36.93 Sq.Kms. As per 2001 census, the population is 17815. The Gram Panchayat consists of 13 wards.

a) SOURCE OF WATER

- Venamada has 700 HH. KWA scheme and bore wells are the main sources of water in this village. However the problem of water scarcity is prevailing in this locality. The frequency of KWA water supply is once in two days for two hours. A water treatment plant of capacity 5 MLD is located in this village. From this plant, water is supplied to 25 - 30 villages. But the quantity of water supplied is not sufficient. HH in the low lying areas consume more water so that, people in raised areas are affected.
- There are 5 wells in the village. The quality of water in the well is good. Proper steps have to be taken to utilize the well properly to satisfy the needs of the people.

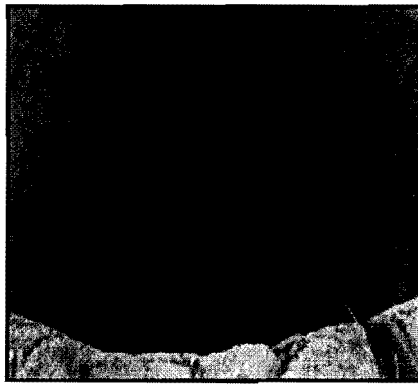

Unused Panchayat Well

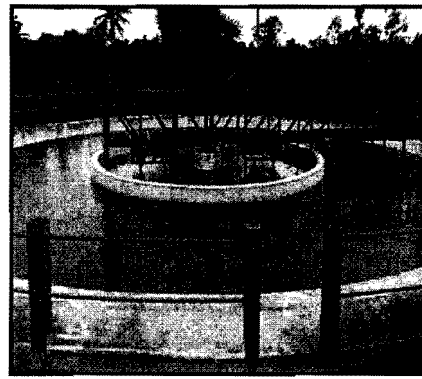

Water treatment Plant

- In Managapuram, the source of water is KWA scheme. Water will be supplied once in 2 days. Other source of water is Panchayat open well and this well is used only by 5 or 6 HH. During summer, water will be supplied by tanker lorry and people will drink the water without any treatment.
- One Panchayat well is in the village and the water quality of the well is good. But the well is not used due to poor maintenance.

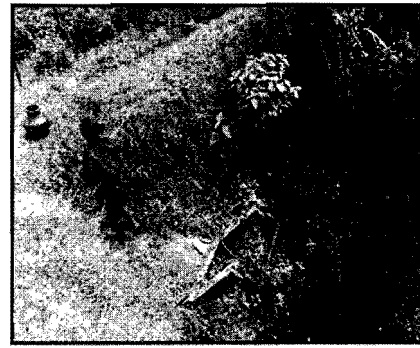
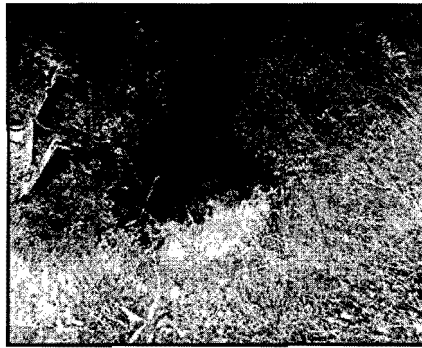

Panchayat open well

- In Iyyamargalai, the source of water is tanker lorry supplied by Panchayat, once in 2 days. The quality of bore well water is very poor. Water is yellowish in colour and fluoride level is high. The people in this village do not use this water. This village is located 10-15 km away from treatment plant, so water is not supplied regularly and also the village is located in upstream direction. Totally 8 taps, 3 bore wells, pond & river are there in this village but water will be available only in rainy season.

**b) WATER QUALITY**

- The problem of fluoride is very high in this locality. Rice cooked with this water turns yellow.

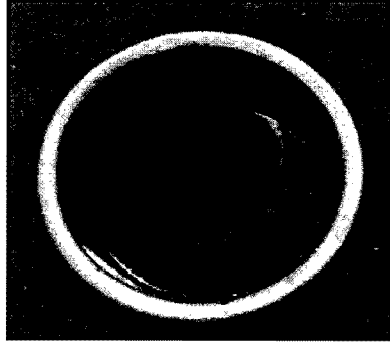

Yellowish water

**c) RAIN WATER HARVESTING**

- Rainwater harvesting system was constructed by Panchayat in 2002-03. The tank capacity is 15,000 litres and another one is 10,000 litres. Now it is not functional because the pipeline is damaged.

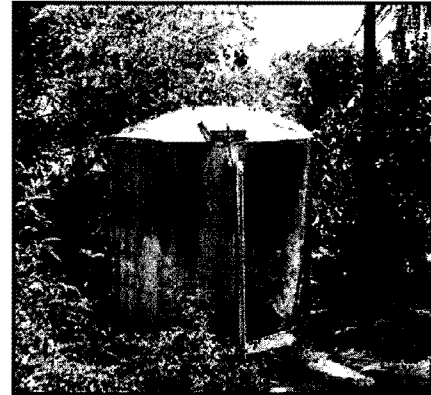

Rain Water Harvesting System

**d) SOLID WASTE**

- No proper method for solid waste disposal. People are dumping the waste in the open land. Collection of waste is not practiced.
- Burning of waste is very common.
- Cow dung is stored in house backyard and it is used as manure.



Solid waste Disposal

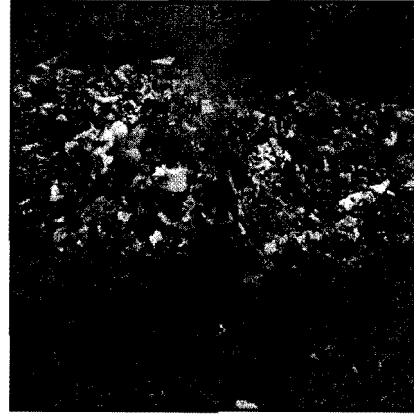

Burning of waste

e) **SEWAGE DISPOSAL**

- Sewer connections are given to 100 houses out of 700 houses. Sewage is not treated and discharged in the open land.

f) **SANITATION**

- Only 50 % of the HH have proper sanitation facility.
- ISL is mostly connected to leachate pit and in some case septic tank.
- The waste from septic tank will be collected by private parties on chargeable basis.
- In remaining areas open defecation is common.

g) **PUBLIC HEALTH & HYGIENE**

- Health centre is located at vannamada.
- PHC conduct awareness program on health & personal hygiene.
- Issue of medicine during rainy season is common.
- Last year the people were affected by water bone diseases i.e. Chikungunya, Typhoid, Hepatitis and viral fever.

**FOCUSED GROUP DISCUSSION HELD ON 8.12.2010 AT ERUTHANPATHY**

In FGD, problems related to drinking water supply, quality of water, sanitation and solid waste disposal were discussed. More than 30 members participated.

- A. Panchayat has already constructed rain water harvesting tank but some are not working due to damage in pipeline. Participants suggested revamping the same.
- B. Since fluoride content is high, suggestion regarding treatment for fluoride was given.
- C. Disposal of solid waste is a major problem in Vannamada area. Participants also suggested providing solid waste management system.

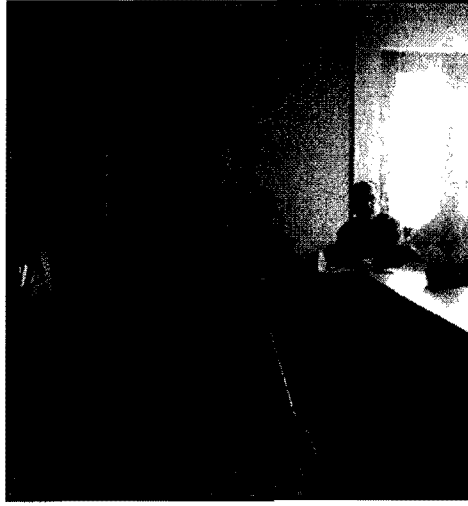

FGD at Eruthenpathy

**REPORT 10 THIRURANGADI  
VILLAGE SURVEY FORMAT**

<b>Identification</b>	
Name of the District	Malappuram
Name of the Block	Thirurangadi
Name of the Gram Panchayat	Thirurangadi
Name of the Villages	Thirurangadi
Terrain	Sloping
Area in Acres	
Population	24,974 as per 2001 census
Distance from the Gram Panchayat	16 kms from Malappuram
Depth of water table (Location wise)	30 feet
<b>Water Supply</b>	
Type of Scheme	Kerala water Authority, Wasco scheme
Source of Water	Bore Well, open well, river (Kadalundi)
Is the well open or covered	Open
Whether the well is Sanitized	Yes
Source of water in summer	Less
Type of distribution network	Pipeline
How drinking water is met in coastal area?	The drinking water is met by near by wells which is having good water
Main source of drinking water	1. Panchayat Tap 2. Public Open Well/Individual Open well
Is there any treatment in case of open well?	Yes
If yes, what treatment is followed?	1. Chlorination 2. Alum or herbs 3. Filtering with cloth
How many households are boiling water & drinking?	80 %
Whether water is boiled or only heated	Boiled
How is the cost aspect maintained for treatment?	By Gram Panchayat
What is the village institutional arrangement for drinking water treatment? Who does the treatment, how often and is it working well?	No
Handling of drinking water	1. Cover 2. Pot or tank with tap
Supply Duration	From 1 Hrs to 2 Hrs
Supply Frequency	Weekly twice
Number of	1. Well - 40 2. Stream - 27 3. Springs - 23
Storage Capacity	30,000 litres and 50,000 litres
Depth of the aquifer (if it is ground water)	50 metres

Is there decline in ground water level Summer	Yes
Winter	No
Is there any maintenance shut down if the source from a canal	No
Cost for the Water Supply / HH	Rs 40-50/Month
Annual O & M expenditure	O & M expenditure is borne by Beneficiary group
Repair and Maintenance	By beneficiary group
Power	KSEB
Whether Technical support is given for O & M?	No
What type of support?	No
Is there is any Rain Water Harvesting Scheme	RWH tank is available at Chinnanvilla colony and Punnamkulam
Is there any conflict between villages for water?	No
<b>Water Quality</b>	
Quality Perception	1. Muddy 2. Bacterial 3. Iron content
Surface water quality in the time of low level flow	Good
How often the water quality is checked?	There is no periodical checking of water quality
Any records maintained for water quality?	Nil
Quality Parameter (Specify parameter and value in ppm)	Nil
Treatment	No
Type of Treatment	Chlorination
Type of Storage	OHT
<b>Environmental Sanitation</b>	
Nature of Defecation	1. Individual Sanitary latrine(ISL) 2. Public latrines 3. Open
Number of ISL	-
ISL Coverage (% of Households)	90 %
No. of Public latrines	-
Whether the latrine is conversion of leach pit to shallow two pit or new	No
How sanitation is managed in coastal areas & hills?	There is no management of sanitation
Is your ISL/Public Latrine connected to	Leachate pit
How often and what process is followed to empty the pits and tanks?	Once the Leachate pit is full, it is closed.
Where other people go for defecation	In the field/Near the Water Resource
Is there any wastewater body	No

Is there any drinking water source near the wastewater body	No
Septic tank/Leachate pit waste disposal	They close the pit
Use of waste as Manure	No
Presence of Sewerage connection	No
Sewerage Coverage (% of households)	No
Sewage Treatment	No
Where Sewerage is disposed finally	Sewage is disposed in the open area.
<b>Solid Waste</b>	
Where do you dispose solid waste	In the open area
Where do you dispose fodder waste dung	House backyard
Do you have compost pit for this waste	No
Locations	No
Distance from village (Km)	Not applicable
What is done with the waste	Burnt
<b>Health &amp; Personal Hygiene</b>	
Health facility	Public Health Centre
Health Staff in Village	Govt Doctor
When do you wash hands?	1. Before & after eating 2. After Defecation
What is used for cleaning hands?	Soap
Frequency of bathing	1. Daily 2. Once in two days
What kind of hygiene messages do villagers most often hear during programs and campaigns and are these useful?	Nil
Common diseases	1. Common Cold & fever 2. Diarrhoea 3. Skin diseases 4. Viral Hepatitis - A
How often is the disease outbreak	Seasonal
Was there a health epidemic due to contaminated water in the past two years?	No
<b>Awareness</b>	
Awareness programs regarding water & sanitation taken up?	Awareness program is conducted by Gram Panchayat and public health centres
How you protect drinking water sources?	Nil
Is there any occasion where the whole village is cleaned & sanitized compulsorily	No

**FIELD STUDY ON 29 NOVEMBER, 2010**

Field study was conducted at Thirurangadi GP on 29 November, 2010. The GP is located in Thirurangadi Block, Malappuram District. As per 2001 census, the population is 24974. The Gram Panchayat consists of 23 wards.

**a) SOURCE OF WATER**

- Thrikkulam Attakulangara consists of 400 families. Open well is the only source of water. No other water supply schemes are seen in the ward. 90 % of the people have individual open wells. But iron is present in the well water. About 75 % of the wells are having iron content and 10 % of the well water is not used for drinking. The quality of a private well located in the ward is good. The diameter and depth of the well are 5 m and 3 m respectively.

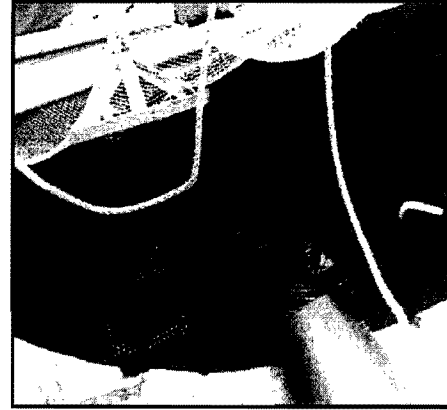
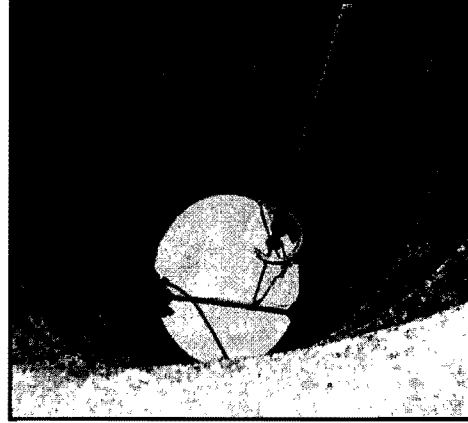

**Well contaminated with iron**

- In Venchali, there are 460 families. The only source of water is open well. KWA scheme covers only 5 % of HH in the ward. People paid Rs. 500 initially for this scheme and monthly Rs. 40 is collected from each HH. Water supply is for 1 - 2 hours, once / twice a week. During summer water supply is less.
- During summer season wells get dried. Private party supplies water by tankers at a cost of 150 for 1000L.



**Private well in Venchali**



- There is a private well which can be used as water source.
- In Azad Nagar and G.K. Nagar, Panchayats mini project scheme was implemented and it is running successfully. But during the summer season, water shortage is seen in the wards. Open well is the source of water. From here, water is pumped and stored in an overhead tank of capacity 50,000 L, and supplied to 70 – 80 families. Initially Rs. 1000 – 1500 was collected from each HH and monthly charge for each HH is Rs. 40 – 50.
- In Kottuvalakkad, Panchayat scheme was implemented but was not successful. HH are not utilizing the water due to salinity. Panchayat spent money and constructed the well of overhead tank capacity Rs. 30,000 L. Initially from each HH Rs. 1000 – 1500 was collected and monthly charge of Rs. 50/ HH are collected. The scheme ran successful only for four months.

**b) SANITATION**

- 90 % of the households have sanitation facility.
- Some households have pit latrines and others have septic tanks.



ISL

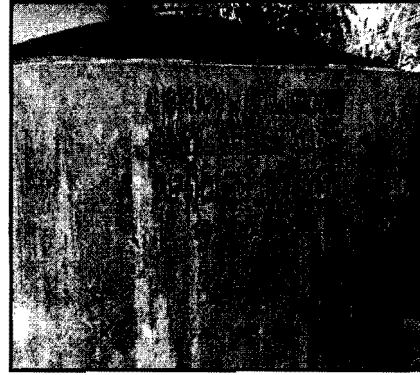

RWH tank in Panchayat  
office

**c) SOLID WASTE**

- Panchayat has acquired 28 cent land for disposing the solid waste without any treatment process.

**d) RAINWATER HARVESTING**

- Panchayat constructed rain water harvesting tank in Panchayat office of capacity 10,000 L and it is functioning.

**e) SEWAGE SYSTEM**

- There is no separate sewerage system.
- Sewage is discharged to nearby land.
- Due to sewage disposal into the land, waste water stagnates and cause diseases.

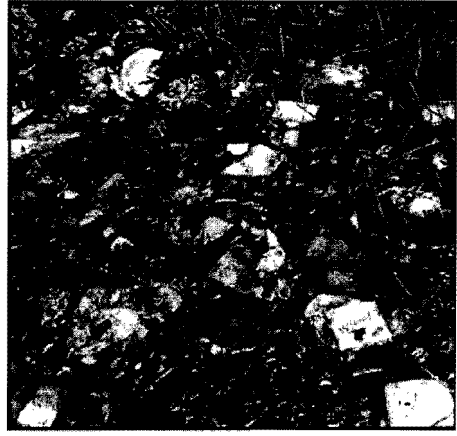

Water Stagnation in Waste Land

**FOCUSED GROUP DISCUSSION HELD ON 29.11.2010 AT THIRURANGADI**

More than 90 members participated in FGD.

- A. Ward No 1, 2, 3,4,5,6 and 23 are located near river and the people are taking water from river.
- B. Some wards are located in the slopy terrain and hence yield is not proper during summer.
- C. In some wards water quality is very poor as iron and salinity are high. Participants expressed, providing treatment.
- D. As there are many NRIs, they are ready to take up the scheme.



FGD at Thirurangadi

**REPORT 11 SULTHAN BATHERY  
 VILLAGE SURVEY FORMAT**

<b>Identification</b>	
Name of the District	Wayanad
Name of the Block	Sulthan Bathery
Name of the Gram Panchayat	Sulthan Bathery
Name of the Villages	Thirunelli, Odapallam and Kaipenchery
Terrain	Sloping/ Hilly
Area in Acres	
Population	42,059 as per 2001 census
Distance from the Gram Panchayat	98 kms from the Kozhikode
Depth of water table (Location wise)	10 metres
<b>Water Supply</b>	
Type of Scheme	Kerala water Authority
Source of Water	Well
Is the well open or covered	Open
Whether the well is Sanitized	Yes
Source of water in summer	Less
Type of distribution network	Pipeline
How drinking water is met in coastal area?	The drinking water is met by nearby Panchayat tap
Main source of drinking water	1. Panchayat Tap 2. Hand Pump 3. Public Open Well/Individual Open well
Is there any treatment in case of open well?	Yes
If yes, what treatment is followed?	1. Chlorination 2. Filtering with cloth
How many households are boiling water & drinking?	80 %
Whether water is boiled or only heated	Boiled
How is the cost aspect maintained for treatment?	By Gram Panchayat
What is the village institutional arrangement for drinking water treatment? Who does the treatment, how often and is it working well?	No
Handling of drinking water	1. Cover 2. Pot or tank with tap
Supply Duration	From 2 Hrs to 6 Hrs
Supply Frequency	Weekly twice or thrice
Number of	1. Well 2. Stream
Storage Capacity	1 lakh litres
Depth of the aquifer (if it is ground water)	150 metres



Is there decline in ground water level Summer	Yes
Winter	No
Is there any maintenance shut down if the source from a canal	No
Cost for the Water Supply/HH	Rs 40/ Month
Annual O & M expenditure	O & M expenditure is borne by Beneficiary Group
Repair and Maintenance	By Beneficiary group
Power	KSEB
Whether Technical support is given for O & M?	No
What type of support?	No
Is there is any Rain Water Harvesting Scheme	There is no Rain Water Harvesting tank in this Gram Panchayat
Is there any conflict between villages for water?	Yes
<b>Water Quality</b>	
Quality Perception	1. Muddy 2. Bacterial 3. Iron content
Surface water quality in the time of low level flow	Bad
How often the water quality is checked?	No periodical checking of water quality
Any records maintained for water quality?	Nil
Quality Parameter (Specify parameter and value in ppm)	Nil
Treatment	No
Type of Treatment	Chlorination
Type of Storage	OHTs
<b>Environmental Sanitation</b>	
Nature of Defecation	1. Individual Sanitary latrine(ISL) 2. Open
Number of ISL	
ISL Coverage (% of Households)	85 %
No. of Public latrines	No
Whether the latrine is conversion of leach pit to shallow two pit or new	No
How sanitation is managed in coastal areas & hills?	Not applicable
Is your ISL/Public Latrine connected to	Leachate pit
How often and what process is followed to empty the pits and tanks?	Once the Leachate pit is full, it is closed
Where other people go for defecation	In the field/ open area
Is there any wastewater body	No
Is there any drinking water source	No

near the wastewater body	
Septic tank/Leachate pit waste disposal	They close the pit
Use of waste as Manure	No
Presence of Sewerage connection	No
Sewerage Coverage (% of households)	No
Sewage Treatment	No
Where Sewerage is disposed finally	Sewage is disposed in the open area
<b>Solid Waste</b>	
Where do you dispose solid waste	In the open area
Where do you dispose fodder waste dung	House backyard
Do you have compost pit for this waste	No
Locations	No
Distance from village (Km)	Not applicable
What is done with the waste	Burnt
<b>Health &amp; Personal Hygiene</b>	
Health facility	Public Health Centre
Health Staff in Village	Govt Doctor
When do you wash hands?	1. Before & after eating 2. After Defecation
What is used for cleaning hands?	Soap
Frequency of bathing	3. Daily 4. Once in two days
What kind of hygiene messages do villagers most often hear during programs and campaigns and are these useful?	
Common diseases	1. Common Cold & fever 2. Diarrhoea 3. Skin diseases 4. Viral Hepatitis – A
How often is the disease outbreak	Seasonal
Was there a health epidemic due to contaminated water in the past two years?	No
<b>Awareness</b>	
Awareness programs regarding water & sanitation taken up?	Awareness program is conducted by Gram Panchayat and public health centres
How you protect drinking water sources?	Nil
Is there any occasion where the whole village is cleaned & sanitized compulsorily	No

**FIELD STUDY ON 1 DECEMBER, 2010**

Field study was conducted at Sulthan Bathery GP on 01 December, 2010. The GP is located in Sulthan Bathery Block, Wayanad District. As per 2001 census, the total population is 42059. The GP consists of 23 wards.

**a) SOURCE OF WATER**

- Thirunelli (Pazahkacolony) ward contains 30 – 40 HH. Panchayat well is the only source of water. The well is 10m deep and 4m dia. Most of the HH are Below Poverty Line category. No scheme is available in the ward. During summer season, due to water scarcity, people collect water from agricultural wells.

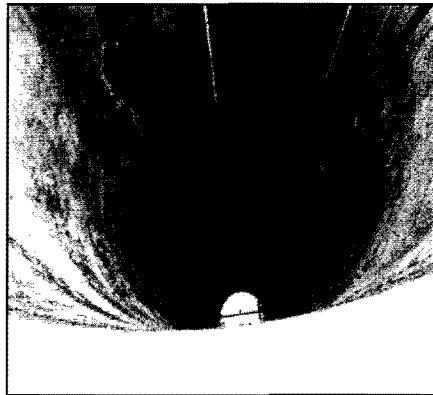

**Open well water source**

**Overhead Tank**

- In Odappalam, Panchayat scheme was implemented. The well is 6 m deep and 5 m dia and the tank capacity is 15,000 – 20,000 litres. The scheme is running successfully. Initially the scheme was planned for 60 families, but due to the shortage of water, only 40 families could avail the facility. Each HH paid Rs. 500 – 1000 initially and paid Rs.40 every month. During summer, people collect water from the agricultural well. The electricity bill and the maintenance works are taken care by the Beneficiary Groups.
- In Pazheri (Puduchola), collector scheme was implemented in 2003 - 2004. Collector funded Rs. 1, 00,000 and Panchayat funded Rs. 35,000 for the scheme. The tank capacity is 10,000 L and the source is from open well (Depth 6 m – 7 m, Diameter – 4 m). Water is muddy during monsoon and during summer water dries up. Each HH pay Rs. 40 as monthly rent. No individual connection is made to houses. People have to collect water from the tank. Electricity bill comes around Rs. 300 – 400 /month.



Overhead Tank & well

- In Kaipenchery (Thoduvelli colony), there are 30 – 40 HH. People in most of HH are Below Poverty Line and daily waged. KWA scheme is implemented and the frequency is twice / thrice a week. In summer the frequency of water supply is once in 10 days. The ward is located in the hilly terrain. People have to come down to get water. There are neither Panchayat wells nor private wells.
- In Kaipenchery (Jawahar Colony), there are 30 – 40 HH. People in most of HH are Below Poverty Line and daily waged. KWA scheme is implemented in the ward and the frequency is twice / thrice a week. In summer the frequency of water supply is once in 10 days. Panchayat constructed (MLA Scheme) one public well. Due to internal problem, people are not using the water. The ward is located in the hilly terrain and people have to come down to get water.



Well in Kaipenchery (MLA scheme)

- Kotakunnu has 40 – 50 HH. Most of the people work for daily wages. The main source of water is Panchayat well. Due to iron contamination, the well is not in use and HH use Panchayat hand pumps.



Open well water source

**b) SOLID WASTE DISPOSAL**

- Panchayat has acquired 50 cent land in Karivalikunnu for solid waste management. The market waste and other solid wastes are disposed at the site.
- Biodegradable wastes are composted in Bio compost tank and non biodegradable wastes were incinerated. The plant was successfully running for 3 years.
- Vegetable waste generated is 75 Kg / day.
- Biogas plant of capacity 10 m<sup>3</sup> is maintained by Rural Innovative Technology Development Society and the biogas generated from plant was used as fuel for Incinerator and for cooking purposes in nearby HH.
- The non biodegradable waste generation is approximately 150 – 250 Kg / day and incinerated. The ash from incinerator was stored and used for leveling the ground.



Solid Waste Disposal



c) SANITATION

- 85 % of the HH have sanitation facilities.
- Remaining HH using open area for defecation.

d) HEALTH & PERSONAL HYGIENE

- Primary Health Centre is available.
- They also conduct health awareness camp.
- Diarrhoea, viral fever and skin diseases are common during monsoon.

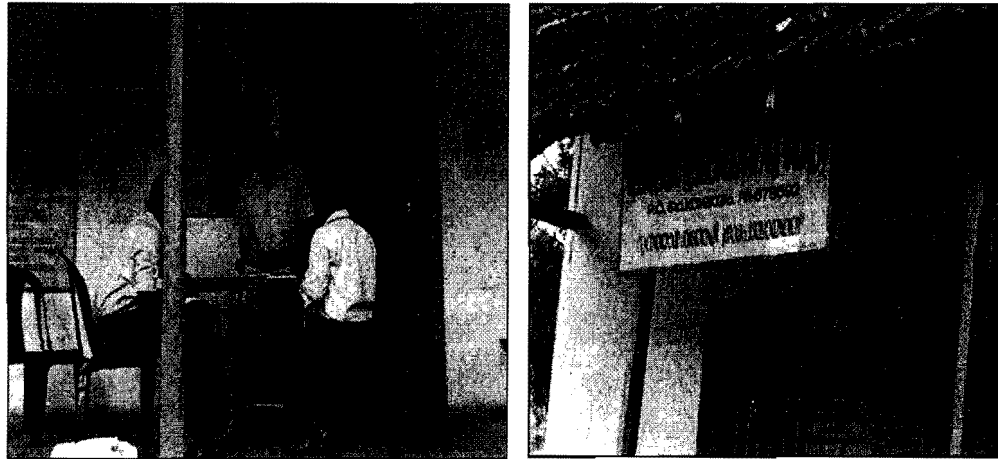

Public Health Centre

**FOCUSED GROUP DISCUSSION HELD ON 02.12.2010 AT SULTHAN BATHERY**

More than 80 participants were present for FGD.



FGD at Sultan Bathery

- A. Already water supply project was implemented but it was not planned for future because source of water and tank capacity was not enough for new HH.
- B. HH located in higher elevation face problem of unequal water distribution when compared to HH located in low lying areas.
- C. Participants suggested providing sanitation facility and rain water harvesting schemes.

REPORT 12 RAMANATTUKARA  
 VILLAGE SURVEY FORMAT

<b>Identification</b>	
Name of the District	Kozhikode
Name of the Block	Kozhikode
Name of the Gram Panchayat	Ramanattukara
Name of the Villages	Ramanattukara
Terrain	Plain/ slopy
Area in Acres	
Population	30,830 as per 2001 census
Distance from the Gram Panchayat	15 kms from Kozhikode
Depth of water table (Location wise)	15 m
<b>Water Supply</b>	
Type of Scheme	Kerala Water Authority, Rajiv Gandhi water supply scheme
Source of Water	Bore Well, Open well
Is the well open or covered	Open
Whether the well is Sanitized	No
Source of water in summer	Less
Type of distribution network	Thorough Panchayat pipeline
How drinking water is met in coastal area?	Drinking water is met by KWA scheme only
Main source of drinking water	1. Panchayat Tap 2. Bore well 3. Public Open Well/Individual Open well
Is there any treatment in case of open well?	Yes
If yes, what treatment is followed?	Chlorination
How many households are boiling water & drinking?	80 %
Whether water is boiled or only heated	Boiled
How is the cost aspect maintained for treatment?	By Gram Panchayat
What is the village institutional arrangement for drinking water treatment? Who does the treatment, how often and is it working well?	No
Handling of drinking water	1. Cover 2. Pot or tank with tap
Supply Duration	From 2 Hrs to 5 Hrs
Supply Frequency	Once in a week/ weekly twice
Number of	1. Bore Well - 15 2. Common well - 4 3. River - 1
Storage Capacity	30,000 litres and 1 lakh litres
Depth of the aquifer (if it is ground water)	100 metres



Is there decline in ground water level Summer	Yes
Winter	No
Is there any maintenance shut down if the source from a canal	No
Cost for the Water Supply/HH	Rs 40/ Month
Annual O & M expenditure	O & M expenditure is borne by contractor
Repair and Maintenance	By contractor
Power	KSEB
Whether Technical support is given for O & M?	No
What type of support?	No
Is there is any Rain Water Harvesting Scheme	No
Is there any conflict between villages for water?	No
<b>Water Quality</b>	
Quality Perception	1. Muddy 2. Bacterial 3. Saline
Surface water quality in the time of low level flow	Fair
How often the water quality is checked?	No periodical checking of water quality
Any records maintained for water quality?	Nil
Quality Parameter (Specify parameter and value in ppm)	Nil
Treatment	No
Type of Treatment	Chlorination
Type of Storage	OHT
<b>Environmental Sanitation</b>	
Nature of Defecation	1. Individual Sanitary latrine(ISL) 2. Open
Number of ISL	
ISL Coverage (% of Households)	90 %
No. of Public latrines	No
Whether the latrine is conversion of leach pit to shallow two pit or new	No
How sanitation is managed in coastal areas & hills?	Sanitation is not managed properly in coastal area
Is your ISL/Public Latrine connected to	Leachate pit/ septic tank
How often and what process is followed to empty the pits and tanks?	Once the Leachate pit is full, it is closed
Where other people go for defecation	In the field/Near the water source
Is there any wastewater body	No
Is there any drinking water source near the wastewater body	No

Septic tank/Leachate pit waste disposal	They disposed into the canal
Use of waste as Manure	No
Presence of Sewerage connection	No
Sewerage Coverage (% of households)	No
Sewage Treatment	No
Where Sewerage is disposed finally	Sewage is disposed into the canal and pond
<b>Solid Waste</b>	
Where do you dispose solid waste	Solid waste is dumped in the barren land
Where do you dispose fodder waste dung	House backyard
Do you have compost pit for this waste	No
Locations	No
Distance from village (Km)	Not applicable
What is done with the waste	Burnt
<b>Health &amp; Personal Hygiene</b>	
Health facility	Public Health Centre
Health Staff in Village	Govt Doctor
When do you wash hands?	1. Before & after eating 2. After Defecation
What is used for cleaning hands?	Soap
Frequency of bathing	1. Daily 2. Once in two days
What kind of hygiene messages do villagers most often hear during programs and campaigns and are these useful?	
Common diseases	1. Common Cold & fever 2. Diarrhoea 3. Skin diseases
How often is the disease outbreak	Seasonal
Was there a health epidemic due to contaminated water in the past two years?	No
<b>Awareness</b>	
Awareness programs regarding water & sanitation taken up?	Awareness program is conducted by Gram Panchayat and Public Health Centres
How you protect drinking water sources?	Nil
Is there any occasion where the whole village is cleaned & sanitized compulsorily	No

**FIELD STUDY ON 26 NOVEMBER, 2010**

Field study was conducted at Ramanattukara GP on 26 November 2010. The GP is located in Kozhikode Block, Kozhikode District. As per 2001 census, the total population of is 30830. The Gram Panchayat consists of 19 wards.

**a) SOURCE OF WATER**

- The source of water in Kolorkunnu is KWA scheme and open wells.
- Out of 360 HH, 275 HH get water from KWA and others from the open well.
- The frequency of KWA water supply is twice/thrice a week for 2 – 3 hours only. Initial payment for each HH was Rs. 2500 and monthly payment is Rs. 25.
- In Pollumkonnu, Panchayat constructed open well in 2000 and the well is 14 m deep and 6 m diameter. A tank of capacity 30,000 litres was constructed. There was no problem for 2 – 3 years. Water supply was disrupted due to damage of pipelines and till now it has not been repaired.
- HH use bore wells and open wells for drinking. About 60 – 70 HH bring water from 500 – 700 m distance.
- The Rajiv Gandhi water supply scheme was implemented in 1999 at Muttumkunnu and Thirichilangadi. The scheme was functioning successfully for 3 – 4 years, after which motor got repaired and the people did not take any action.
- The two wards are located in a slopy terrain. Some of the HH are in higher elevation and others in the lower elevation. Water distribution is not equal and confliction arises among the people in the localities. HH pay Rs. 40 / Month. A storage tank of 60 feet depth and 5 m diameter is available.
- The KWA gets water from bore wells and open wells. KWA mixes bore well water and well water in the tank and then they distribute to the households. Since the bore water is saline, the water is mixed with well water.



Open well



Panchayat tap

- Open well is 6 m depth and 5 m diameter. The depth of the bore well is 300 feet. The capacity of the motor is 10 HP and the capacity of the tank is 1,00,000 litres.

**b) WATER QUALITY**

- There are many ponds in the GP but most of them are contaminated.
- Due to poor solid waste management system, water gets contaminated.

**c) SOLID WASTE**

- In Ramanattukara solid waste is a major problem. Before 7 years, incinerator was in use. The plant is not functioning due to problem in the incinerator.
- At present, the Panchayat collects the waste and they are disposed in open land (approximately 1.5 acres).
- A large pit was dug, the waste was disposed into the pit without segregation and closed. Due to this process, the land and the streams get contaminated.
- During the monsoon, the solid waste blocks the stream flow.

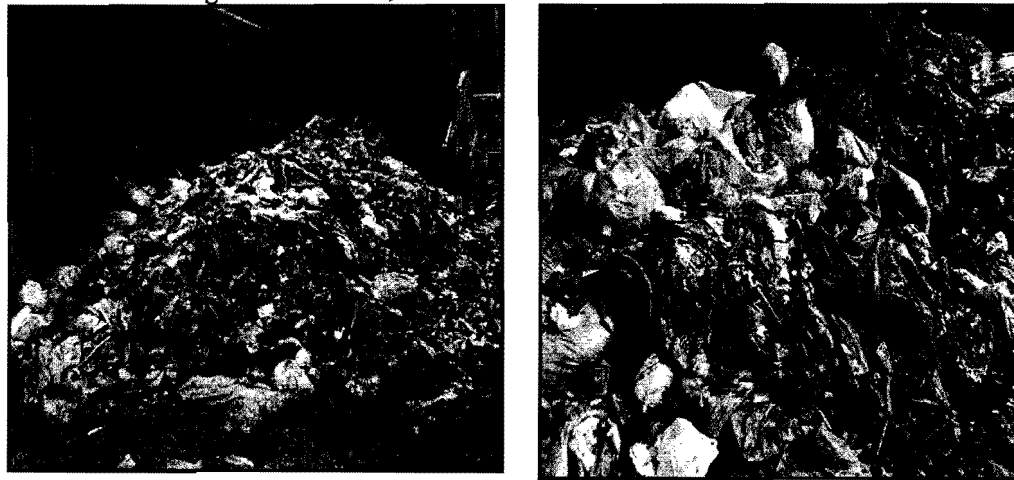

Solid waste dumping

**d) SANITATION**

- The GP has 90 % sanitation facility.
- Most of the HH have pit latrines. Only newly constructed houses have septic tanks.

**e) HEALTH & PERSONAL HYGIENE**

- Primary Health Centre is available at Ramanattukara.
- They conduct health awareness program on water borne diseases.
- They also provide bleaching powder for disinfection.

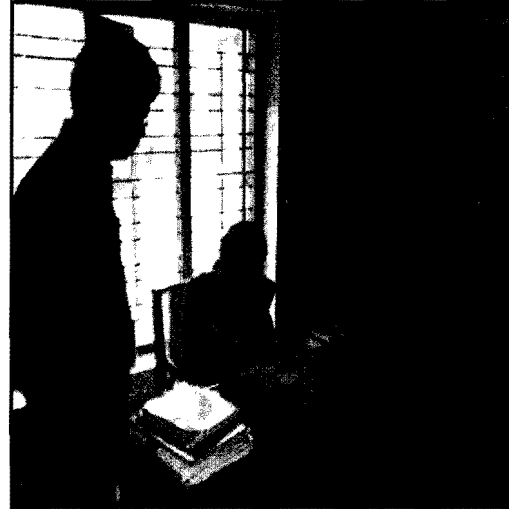
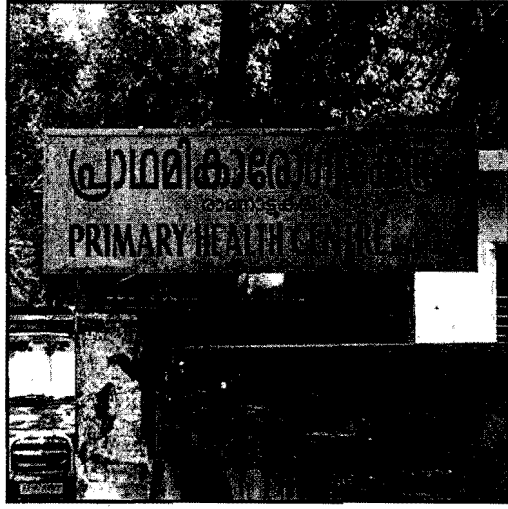

Primary Health centre

**FOCUSED GROUP DISCUSSION HELD ON 27.11.2010**

More than 100 participants were present for the FGD.

- A. During summer, sea water mixes up in stream. So, the water is saline and it cannot be used for drinking. Suggestion was given to construct a check dam to provide water in summer.
- B. Solid waste is a major problem in Ramanattukara. During monsoon, the flood occurs due to blockage in streams. Participants suggested solid waste management facility.
- C. Totally 13 schemes were implemented but 50% of schemes are not functioning due to technical and maintenance problem. Participants expressed revamping the schemes.
- D. Participants were ready to take up Solid waste management scheme under Jalanidhi -2
- E. The Panchayat does not maintain any record for the scheme which is in operation and proper maintenance of record is necessary.



Focused Group Discussion

**REPORT 13 ENMAKAJE  
VILLAGE SURVEY FORMAT**

<b>Identification</b>	
Name of the District	Kasargod
Name of the Block	Manjeswaram
Name of the Gram Panchayat	Enmakaje
Name of the Villages	Charavkad, Kajampady
Terrain	Plain/Slopy
Area in Acres	
Population	26,000 as per 2001 census
Distance from the Gram Panchayat	19 kms from the Kasargod
Depth of water table (Location wise)	15 m
<b>Water Supply</b>	
Type of Scheme	Kerala water Authority
Source of Water	Bore well, Well, River and Surangam
Is the well open or covered	Open
Whether the well is Sanitized	Yes
Source of water in summer	Less
Type of distribution network	Pipeline
How drinking water is met in coastal area?	The drinking water is met by Panchayat tap
Main source of drinking water	1. Public tap 2. Surangam 3. Hand Pump 4. Public Open Well/Individual Open well
Is there any treatment in case of open well?	Yes
If yes, what treatment is followed?	1. Chlorination 2. Filtering with cloth
How many households are boiling water & drinking?	85 %
Whether water is boiled or only heated	Boiled
How is the cost aspect maintained for treatment?	By Gram Panchayat and Beneficiary Group
What is the village institutional arrangement for drinking water treatment? Who does the treatment, how often and is it working well?	No
Handling of drinking water	1. Cover 2. Pot or tank with tap
Supply Duration	From 2 Hrs to 4 Hrs
Supply Frequency	Weekly twice or thrice in a week
Number of	1. Well 2. Stream
Storage Capacity	33,000 litres
Depth of the aquifer (if it is ground water)	150 metres





Is there decline in ground water level Summer	Yes
Winter	No
Is there any maintenance shut down if the source from a canal	No
Cost for the Water Supply/HH	Rs 60/ Month
Annual O & M expenditure	O & M expenditure is borne by Gram Panchayat and Beneficiary Group
Repair and Maintenance	By Beneficiary group
Power	KSEB
Whether Technical support is given for O & M?	No
What type of support?	No
Is there is any Rain Water Harvesting Scheme	Rain Water Harvesting tank is available at Govt Higher secondary school, Vani nagar
Is there any conflict between villages for water?	Yes
<b>Water Quality</b>	
Quality Perception	1. Muddy 2. Bacterial 3. Iron content
Surface water quality in the time of low level flow	Bad
How often the water quality is checked?	No periodical checking of water quality
Any records maintained for water quality?	Nil
Quality Parameter (Specify parameter and value in ppm)	Nil
Treatment	No
Type of Treatment	Chlorination
Type of Storage	OHTs
<b>Environmental Sanitation</b>	
Nature of Defecation	1. Individual Sanitary latrine(ISL) 2. Public latrine 3. Open
Number of ISL	
ISL Coverage (% of Households)	85 %
No. of Public latrines	No
Whether the latrine is conversion of leach pit to shallow two pit or new	No
How sanitation is managed in coastal areas & hills?	Not applicable
Is your ISL/Public Latrine connected to	Leachate pit
How often and what process is followed to empty the pits and tanks?	Once the Leachate pit is full, it is closed
Where other people go for defecation	In the field/ open area
Is there any wastewater body	No

Is there any drinking water source near the wastewater body	No
Septic tank/Leachate pit waste disposal	They closed the pit
Use of waste as Manure	No
Presence of Sewerage connection	No
Sewerage Coverage (% of households)	No
Sewage Treatment	No
Where Sewerage is disposed finally	Sewage is disposed in the open area
<b>Solid Waste</b>	
Where do you dispose solid waste	In the open area
Where do you dispose fodder waste dung	House backyard
Do you have compost pit for this waste	No
Locations	No
Distance from village (Km)	Not applicable
What is done with the waste	Burnt and disposed in the open area
<b>Health &amp; Personal Hygiene</b>	
Health facility	Public Health Centre
Health Staff in Village	Govt Doctor
When do you wash hands?	1. Before & after eating 2. After Defecation
What is used for cleaning hands?	Soap
Frequency of bathing	1. Daily 2. Once in two days
What kind of hygiene messages do villagers most often hear during programs and campaigns and are these useful?	Nil
Common diseases	1. Common Cold & fever 2. Diarrhoea 3. Skin diseases 4. Viral Hepatitis – A
How often is the disease outbreak	Seasonal
Was there a health epidemic due to contaminated water in the past two years?	No
<b>Awareness</b>	
Awareness programs regarding water & sanitation taken up?	Awareness program is conducted by Gram Panchayat and public health centres
How you protect drinking water sources?	Nil
Is there any occasion where the whole village is cleaned & sanitized compulsorily	No

## FIELD STUDY ON 03 DECEMBER, 2010

Field study was conducted at Enmakaje GP on 3rd December 2010. The GP is located in Manjeswaram Block, Kasargod District. As per 2001 census, the population is 26000. The Gram Panchayat has 17 wards.

## a) SOURCE OF WATER

- Chavarkad has 307 HH. At present, the main source of water is Chavarkad River and open well. The scheme was implemented by KWA before 7 years. Bore well of depth 200 ft and overhead tank of capacity 33,000 litres were constructed. Only public taps were provided. The scheme was successful only for 2 years and later it failed due to the shortage of water. About 75 HH were benefitted from this scheme. People have to travel 500 m – 800 m to fetch water from the river. Panchayat has constructed 3 wells but during summer the water in the wells dries up.



Over Head Tank

- Kajampady (SC Colony) has 40 - 50 HH and the HH fall under Below Poverty Line category. KWA has constructed 2 bore wells and a storage tank of capacity 10,000 litres.
- Due to water scarcity in bore wells and the damaged pipe lines, the project was not successful. At present hand pump is the only source of water.



**Hand pump**

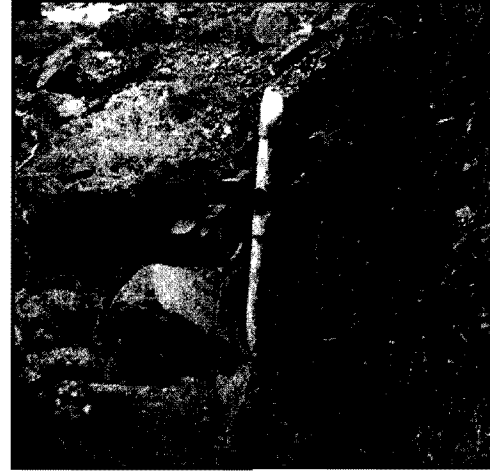

**Damaged pipeline**

- In Swarga, Vaninagar and Kanjampady, the main water source is Surangam. The terrain is such that the flow in the rivers is high during monsoon and less in summer. People therefore depend on ground water and a special water harvesting structure called Surangam. It is a horizontal well mostly excavated from hard laterite rock formations. The excavation continues until a good amount of water is struck. Water seeps out of the hard rock and flows out of the tunnel and collected in an open pit constructed outside the Surangam.

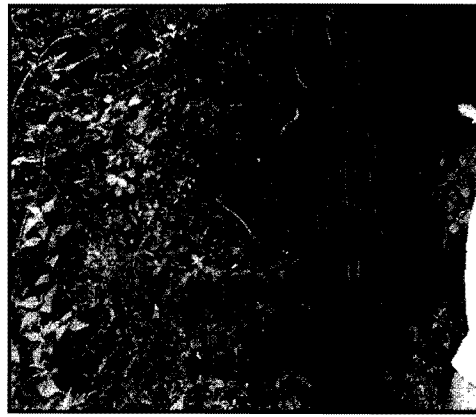

**Front view of Surangam**

- A Surangam is about 0.45-0.70 metres (m) wide and about 1.8-2.0 m high. The length varies from 50-300m. Usually several subsidiary Surangams are excavated inside the main one. If the Surangam is very long, a number of vertical air shafts are provided to ensure atmospheric pressure inside.

**b) RAIN WATER HARVESTING**

- In Vaninagar, rain water harvesting scheme was constructed in Government Higher Secondary School at Vaninagar by NGO. Now this is not working, due to leakage in the structure. As a result, water is not getting stored in the tank.

c) SANITATION

- 30 % of the HH belong to Below Poverty Line category so proper sanitation facilities cannot be seen. Kerala Government provided Rs. 2000 – 2500 / per home for constructing latrines. HH use pit latrines and dispose the waste in the field.
- In Swarga, the GP constructed public latrine in 1999 – 2000. This latrine is being used by the people in and around the locality.

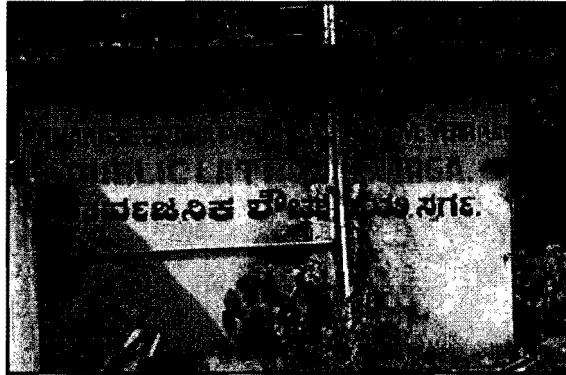

Public Toilet

d) SOLID WASTE

- No proper method of disposal of solid waste is practiced.
- People are burning plastic and other waste near their houses or nearby land.

e) PUBLIC HEALTH & HYGIENE

- Public Health Centre is available at Vani nagar.
- They also conduct health awareness program in the Gram Panchayat.

FOCUSED GROUP DISCUSSION ON 4.12.2010 AT ENMAKAJE

The total no of participants were more than 80.



FGD at Enmakaje

- A. Adksthala River covers six wards 1, 2, 3, 4, 17 and 16. Participants suggested constructing water tank and supplying to these wards will help preventing water scarcity in summer.
- B. Participants expressed reduction in beneficiary contribution percentage.
- C. All the wards in the GP are located in hilly terrain. The Panchayat has already dug bore wells and open wells in some wards but in summer, there is acute water scarcity. So, people bring the water from a distance of 1 to 1.5 km. Participants suggested rainwater harvesting system for each HH.
- D. The Panchayat is providing Rs.2000 to 2500 per home for constructing sanitation facility, people below poverty level expressed the amount to be insufficient, as constructing sanitation required Rs.10000 to 15000.
- E. Hydrological testing was not conducted in many places.

**REPORT 14 KODOM BELUR  
VILLAGE SURVEY FORMAT**

<b>Identification</b>	
Name of the District	Kasargod
Name of the Block	Kanhangad
Name of the Gram Panchayat	Kodombelur
Name of the Villages	Wayambu , Podavadukkam
Terrain	Plain/Slopy
Area in Acres	
Population	23,934 as per 2001 census
Distance from the Gram Panchayat	27 kms from the Kasargod
Depth of water table (Location wise)	30 m
<b>Water Supply</b>	
Type of Scheme	Kerala water Authority, EMS Bhavan Puddathi Scheme and Jalanidhi
Source of Water	Bore well, Private Well, River
Is the well open or covered	Open
Whether the well is Sanitized	Yes
Source of water in summer	Less
Type of distribution network	Pipeline
How drinking water is met in coastal area?	The drinking water is met by Panchayat tap
Main source of drinking water	1. Public tap 2. Hand Pump 3. Public Open Well/Individual Open well
Is there any treatment in case of open well?	Yes
If yes, what treatment is followed?	1. Chlorination 2. Filtering with cloth
How many households are boiling water & drinking?	85 %
Whether water is boiled or only heated	Boiled
How is the cost aspect maintained for treatment?	By Gram Panchayat and Beneficiary Group
What is the village institutional arrangement for drinking water treatment? Who does the treatment, how often and is it working well?	No
Handling of drinking water	1. Cover 2. Pot or tank with tap
Supply Duration	From 2 Hrs to 5 Hrs
Supply Frequency	Weekly twice or thrice
Number of	1. Well 2. Stream
Storage Capacity	RWH tank capacity of 5000 litres
Depth of the aquifer (if it is ground water)	150 metres
Is there decline in ground water level	
Summer	Yes
Winter	No
Is there any maintenance shut down if the source from a canal	No

Cost for the Water Supply/HH	Rs 60/ Month
Annual O & M expenditure	O & M expenditure is borne by Gram Panchayat and Beneficiary Group
Repair and Maintenance	By Beneficiary group
Power	KSEB
Whether Technical support is given for O & M?	No
What type of support?	No
Is there is any Rain Water Harvesting Scheme	Rain Water Harvesting tank is available at most of the houses by Jalanidhi scheme
Is there any conflict between villages for water?	Yes
<b>Water Quality</b>	
Quality Perception	1. Muddy 2. Bacterial 3. Iron content
Surface water quality in the time of low level flow	Bad
How often the water quality is checked?	No periodical checking of water quality
Any records maintained for water quality?	Nil
Quality Parameter (Specify parameter and value in ppm)	Nil
Treatment	No
Type of Treatment	Chlorination
Type of Storage	OHTs
<b>Environmental Sanitation</b>	
Nature of Defecation	1. Individual Sanitary Latrine(ISL) 2. Public latrine 3. Open
Number of ISL	
ISL Coverage (% of Households)	70 %
No. of Public latrines	No
Whether the latrine is conversion of leach pit to shallow two pit or new	No
How sanitation is managed in coastal areas & hills?	Not applicable
Is your ISL/Public Latrine connected to	Leachate pit
How often and what process is followed to empty the pits and tanks?	Once the Leachate pit is full, it is closed.
Where other people go for defecation	In the field/ open area
Is there any wastewater body	No
Is there any drinking water source near the wastewater body	No
Septic tank/Leachate pit waste disposal	They closed the pit
Use of waste as Manure	No
Presence of Sewerage connection	No
Sewerage Coverage (% of households)	No
Sewage Treatment	No
Where Sewerage is disposed finally	Sewage is disposed in the open area
<b>Solid Waste</b>	
Where do you dispose solid waste	In the open area
Where do you dispose fodder waste dung	House backyard





Do you have compost pit for this waste	No
Locations	No
Distance from village (Km)	Not applicable
What is done with the waste	Burnt and disposed in the open area
<b>Health &amp; Personal Hygiene</b>	
Health facility	Public Health Centre
Health Staff in Village	Govt Doctor
When do you wash hands?	1. Before & after eating 2. After Defecation
What is used for cleaning hands?	Soap
Frequency of bathing	1. Daily 2. Once in two days
What kind of hygiene messages do villagers most often hear during programs and campaigns and are these useful?	
Common diseases	1. Common Cold & fever 2. Diarrhoea 3. Skin diseases
How often is the disease outbreak	Seasonal
Was there a health epidemic due to contaminated water in the past two years?	No
<b>Awareness</b>	
Awareness programs regarding water & sanitation taken up?	Awareness program is conducted by Gram Panchayat and public health centres
How you protect drinking water sources?	Nil
Is there any occasion where the whole village is cleaned & sanitized compulsorily	No

**FIELD VISIT ON 05 DECEMBER, 2010**

Field study was conducted at Kodombelur GP on 5 December 2010. The GP is located in Kanhangad Block, Kasargod District. The Gram Panchayat consists of 19 wards.

**a) SOURCE OF WATER**

- In Vyambu, Jalanidhi- 1 was implemented in 2005 - 2006. The source of water is bore well of 170 feet depth and an overhead tank of capacity of 5000 Litres. There are about 30 Beneficiary Groups in the ward. The scheme was running successfully. Initially each HH spent Rs. 1000 - 1500 and a monthly contribution of Rs. 40 - 50 is collected. Maintenance cost comes to around Rs. 5000 - 6000 per year. During summer there is water scarcity.

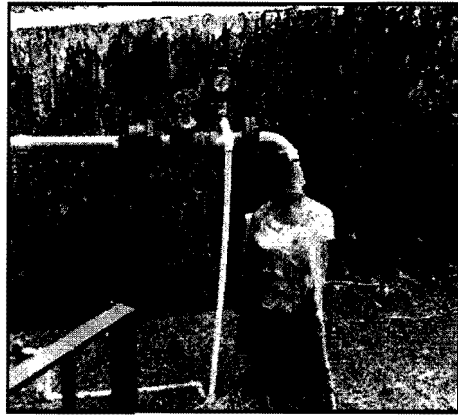

**Bore well**



**Over head tank**

- In Podavadukkam, there are 15 - 20 HH. The source of water is Panchayat and private open well. During summer, water in the well dries up and hence people used to bring water from a private well located at the distance of 500 - 800 m.
- Jalanidhi-1 was implemented in ward no.8. Initially KWA dug the well, which was handed over to Jalanidhi. Under Jalanidhi, a tank and pump was provided to supply water for 60 families. Initially the scheme was planned for 80 families but now only 60 families are receiving water due to shortage of water. Water meter is not fixed and as a result, there is conflict among HH regarding supply of water. Now 20 HH are voluntarily not using the water received from this scheme.
- New people cannot join in the scheme since there is a problem of water shortage in summer. So it was decided to dig an open well but the work was not completed. The representatives of Jalanidhi informed that the work will be taken up in Jalanidhi - 2.

**b) SANITATION**

- 30 % of the HH belong to Below Poverty Line category so proper sanitation facilities cannot be seen.
- Panchayat provided Rs. 2000 - 2500 /- per HH for constructing latrines. But the people are saying that this amount is not sufficient for constructing toilet and septic tank.
- Community latrines were provided by Jalanidhi-1.

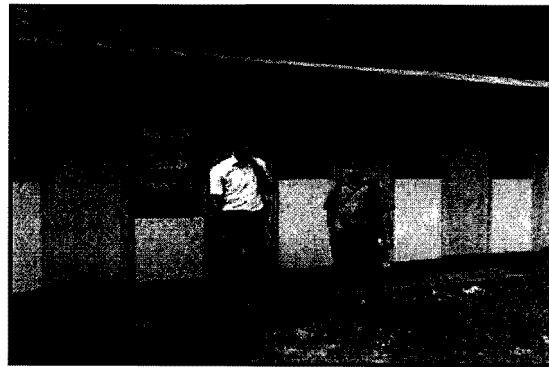

**Sanitation facility by Jalanidhi - 1**

c) **SOLID WASTE**

- No proper method of disposal of solid waste is practiced.
- People burn plastic and other waste near their houses or nearby land.

d) **RAIN WATER HARVESTING**

- In Jalanidhi - 1 about 1230 RWH structures were constructed. All the structures are functioning except few which failed due to structural problem. The capacity of rain water harvesting tank is 10,000 – 15,000 L.

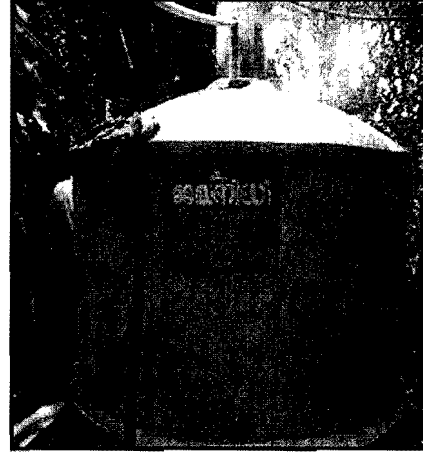

Rain Water Harvesting

e) **WATER QUALITY**

- Water is likely to contain iron due to corrosion of the GI pipe used in distribution line.

**FOCUSED GROUP DISCUSSION HELD ON 6.12.2010 AT KODOM BELUR**

Total no. of participants was more than 140.

- A. Jalanidhi -1 was implemented and the scheme is running successfully. People are interested in contribution towards Jalanidhi - 2.
- B. Cost estimation for each scheme to be prepared for hilly terrain as the cost estimate is high for hilly regions.
- C. The jalanidhi-1 rain water harvesting scheme is working successfully and hence 90% of HH are interested in rainwater harvesting system. Participants suggested increasing the capacity of rain water harvesting tank.
- D. Participants suggested using ISI make motor, pipe, etc.
- E. Participants are interested in sanitation facility.
- F. Already few water schemes were implemented but below poverty level (SC/ST) people could not maintained the scheme due to economic problem and poor education. In such cases participants suggested Panchayat's cooperation with people.
- G. Participants suggested providing contribution in installments.
- H. Participants suggested visit of technical person after implementation of the scheme.

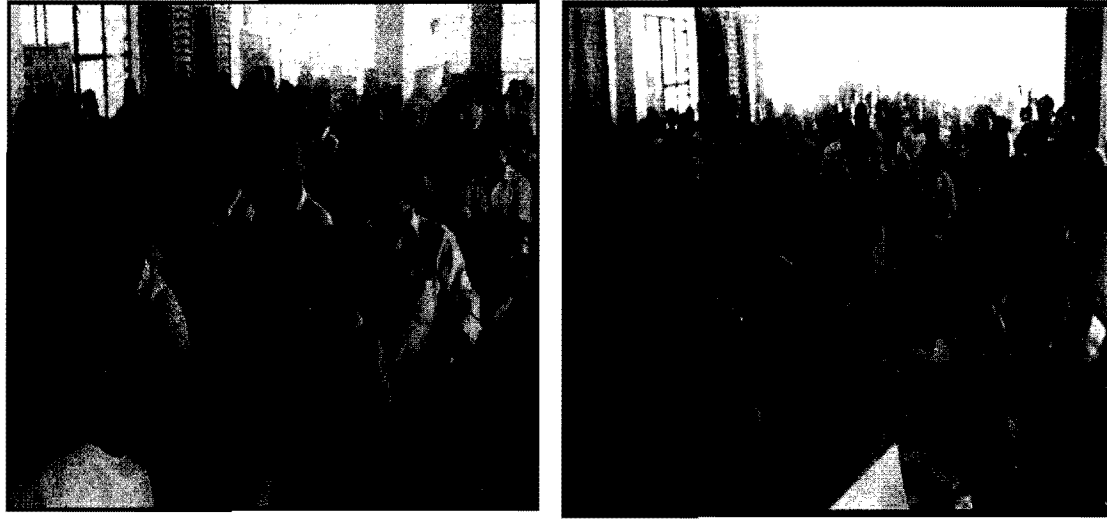

FGD at Kodom Belur

### Annexure 8 - Guidelines for Sanitary Survey of Water Supply Sources

#### Current Practice

The KRWSA has to conduct sanitary survey of rural water supply sources while initially installing the source. However annual survey of the sources after installation is not being done systematically.

#### Guidelines for Sanitary Survey in KRWSA

The guidelines for Sanitary Survey given in this Annexure are in line with the guidelines documented in the Implementation Manual on *National Rural Water Quality Monitoring and Surveillance Programme* published in 2004 by the Rajiv Gandhi National Drinking Water Mission, Department of Drinking Water Supply, Ministry of Rural Development, and Government of India. These guidelines will be applied for Sanitary Surveys in the KRWSA

#### Sampling Frequency

S. No.	Source and mode of water supply	Minimum number of sanitary inspections per year		
		By SO	By GPE / SE of RPMU	By D(T) of PMU
<b>Ground Water</b>				
1.	Shallow tube wells with hand pumps	4 (including once initially while filling the EDS of the scheme)	Once initially (while filling the EDS) and thereafter as situation demands	
2.	Deep tube wells with hand pumps	4 (including once initially while filling the EDS of the scheme)	Once initially (while filling the EDS) and thereafter as situation demands	
3.	Wells and piped supplies	1 (including once initially while filling the EDS of the scheme)	1 (including once initially while filling the EDS of the scheme)	Once initially thereafter once every 5 years or as situation demands
<b>Surface Water and/or chlorinated and piped supplies</b>				
1.	Population up to 5000	12 (including once initially while filling the EDS of the scheme)	2 (including once initially there after initially while filling the once every 5 years or as EDS of the scheme)	Once initially thereafter once every 5 yrs or as situation demands
2.	Population 5000-20000		24-48 (including once initially while filling the EDS of the scheme)	Once a year
3.	Community rainwater collection systems	1 (including once initially while filling the EDS of the scheme)	1 (including once initially while filling the EDS of the scheme)	



**Sanitary Survey Procedure and Recording Forms**

Sanitary inspection requires detailed examination of the water-supply system, especially at its key points in order to check whether the installations are satisfactory and whether the various operations are being carried out properly. The recommended method of undertaking an inspection is to follow the natural sequence: starting with the source water and its intake, and going on to treatment, disinfection, storage, distribution, etc. Observations are recorded on preset forms. Formats for various sources are given below:

**SANITARY SURVEY FOR THE ASSESSMENT OF RISKS OF CONTAMINATION OF DRINKING WATER SOURCES**

1 Type of facility : Shallow and Deep hand pumps (tube well)

**General Information**

- i. Location : Village.....  
Gram Panchayat.....  
District.....
- ii. Code No :
- iii. Water authority Panchayat  
President Community  
Representative Signature :
- iv. Date of Visit :
- v. Is Water Sample Taken.....Sample No.....Acceptable/Reject able

2.

S. No	Specific Diagnostic Information for Assessment	Risks	
		Yes	No
1	Is there a latrine with in 10 m of hand pump		
2	Is there any other source of pollution within 10m of the hand pump?		
3	Is there any stagnant water with in 2m of the cement floor of hand pumps?		
4	Is the hand pump has drainage channel? Is it broken? Does it need cleaning?		
5	Is there any ponding on the cement floor around the hand pump?		
6	Are there any crackers on the cement floor around the hand pump?		
7	Is printing of bore well required dry season?		
<b>Total Score of risks / 7</b>			

Containment Risk Score: 6-7 = V.high 5-6 = High 3-4 = Intermediate 0-2 = low  
Number of YES to be counted

3. Result and recommendation:

--	--	--	--	--	--

The following importance point of risks (Seniority from top) was noted and the authority advised on remedial action.



**SANITARY SURVEY FOR THE ASSESSMENT OF RISKS OF CONTAMINATION OF DRINKING WATER SOURCES**

1 Type of facility : Deep Borehole

**General Information**

- i. Location : Village.....  
Gram Panchayat.....  
District.....
- ii. Code No :
- iii. Water authority Panchayat  
President Community  
Representative Signature :
- iv. Date of Visit :
- v. Is Water Sample Taken.....Sample No.....Acceptable/Reject able

2.

S.No.	Specific Diagnostic Information for Assessment	Risks	
		Yes	No
1	Is there a latrine or sewer with in 30 m of hand pump		
2	Is the nearest latrine unsewered? (a pit latrine that percolates to soil)		
3	Is there any other source of pollution within 10m of the hand pump?		
4	Is there any other source of pollution within area of the well?		
5	Is there is drainage way from the pump house fully?		
6	Is there fencing around the installation drainage is any way which allow animals access or any entry?		
7	Is the floor of the hand pump permeable to water?		
8	Is the well seal insanitary?		
9	Does the chlorination record show any interruption in dosing?		
10	Is the free chlorine residual at the sample tap less than 0.2 mg/l?		
<b>Total Score of risks / 10</b>			

**Containment Risk Score:** 9:10 = V.high 6-8 = High 3-5 = Intermediate 0-3 = low

Number of YES to be counted

3. Result and recommendation:

--	--	--	--	--

The following importance point of risks (Seniority from top) was noted and the authority advised on remedial action.



**SANITARY SURVEY FOR THE ASSESSMENT OF RISKS OF CONTAMINATION OF DRINKING WATER SOURCES**

1 Type of facility : Gravity Feed Piped Suppliers

**General Information**

- i. Location : Village.....  
Gram Panchayat.....  
District.....
- ii. Code No :
- iii. Water authority Panchayat  
President Community  
Representative Signature :
- iv. Date of Visit :
- v. Is Water Sample Taken.....Sample No.....Acceptable/Reject able

2.

S.No.	Specific Diagnostic Information for Assessment	Risks	
		Yes	No
<b>Conduction pipe to reservoir</b>			
1	Is there any point leakages between the source and the reservoir?		
2	If there is any pressure break boxes, or their covers insanitary?		
3	Is there inspection cover on the reservoir insanitary?		
4	Are any air vents insanitary?		
5	Do the roof and walls of the reservoir allow any water to enter (is the reservoir cracked)?		
6	Is the reservoir water unchlorinated?		
<b>Distribution pipes</b>			
7	Does the water entering the distribution pipes have less than 0.4 ppm free residual chlorine (<0.4 ppm)		
8	Are there any leaks in any part of the distribution system?		
9	Is pressure low in any part of the distribution system?		
10	Does any sample of water in the principal distribution pipes have less than 0.2 ppm free residual chlorine?		
<b>Total Score of risks / 10</b>			

**Containment Risk Score:** 9:10 = V.high 6-8 = High 3-5 = Intermediate 0-3 = low  
Number of YES to be counted

3. Result and recommendation:

--	--	--	--	--	--

The following importance point of risks (Seniority from top) was noted and the authority advised on remedial action.





**SANITARY SURVEY FOR THE ASSESSMENT OF RISKS OF CONTAMINATION OF DRINKING WATER SOURCES**

1 Type of facility : Rain Water tank Catchment

**General Information**

- i. Location : Village.....  
Gram Panchayat.....  
District.....
- ii. Code No :
- iii. Water authority Panchayat  
President Community  
Representative Signature :
- iv. Date of Visit :
- v. Is Water Sample Taken.....Sample No.....Acceptable/Reject able

S. No.	Specific Diagnostic Information for Assessment	Risks	
		Yes	No
1	Is there any contamination of the roof catchment area? E.g. plants		
2	Are the gathering channels which make water dirty?		
3	Is there any deficiency in the fiber at the tank inlet?		
4	Is there other point of entry to the tank which is not properly covered?		
5	Is there any defect in the walls on top of the tank? E.g. Cracks.		
6	Is there water collection area inadequately drained?		
7	Are there any cracks on the cement floor around the hand pumps?		
8	Is printing of bore well required during dry season?		
9	Is there any source of pollution around the tank or water collection area?		
10	Is the water backed left in a position that it may be contaminated?		
<b>Total Score of risks / 10</b>			

**Containment Risk Score:** 9:10 = V.high 6-8 = High 3-5 = Intermediate 0-3 = low  
Number of YES to be counted

3. Result and recommendation:

--	--	--	--	--	--

The following importance point of risks (Seniority from top) was noted and the authority advised on remedial action.



## Annexure 9 -Guidelines for Identification and Selection of Water Supply Sources

Groundwater aquifers are the main source of water in Kerala state for tapping water for various uses. The aquifers are classified as confined aquifer and unconfined aquifer. The wells tapping water from confined aquifer are called deep wells, which have the recharge zone far away from the well location. In some locations the water quality of deep wells may have problems (fluoride/salinity/nitrate/iron etc.). The wells tapping water from unconfined aquifer are called shallow wells, which have the recharge zone around the wells. These wells are likely to dry up during summer and liable for contamination from local pollution sources unless they are sanitary protection is provided. Presently the KRWSA broadly follows the below procedure for identification of sources.

### A. Priority for the selection of sustainable sources for rural water supply

1. Groundwater source with acceptable quality (without any treatment except disinfection). These sources are preferred for Small Water Supply Schemes (SWSS).
2. When option (1) is not possible as the groundwater quality is problematic (fluoride/brackish/nitrate/iron etc.), distant surface water source which requires only simple filtration and disinfection will be preferred. These sources are preferred for multi GP schemes/ Large Water Supply Schemes (LWSS) involving number of habitations (multi GP schemes may be located away from the habitations and require treatment and pumping adding to O&M costs).
3. When option (1) and (2) are not possible due to isolation of the habitation and its location at high elevation, and if the local groundwater source is sustainable throughout the year but high TDS (> 2000 mg/L) is the only problem, the local source will be selected. Water from the local source will be treated with innovative technology such as Reverse Osmosis (RO). As RO plants have certain problems (for example, safe disposal of brine), this option will be chosen only under exceptional circumstances.

### B. Water Quality Testing

Before selecting the source the raw water quality will be tested to check conformity with the drinking water standards.

### C. Spacing between the proposed well and the existing groundwater structure to avoid interference

When a new well is located close to an existing well, the cone of influence of both wells may overlap and affect the yielding potential of both the wells. While locating new wells the spacing between new well and the existing well will, therefore, be fixed appropriately. The following table recommends the spacing between the existing groundwater abstractions structures and the proposed wells.



S. No	Situation	Recommended spacing between any two wells (m)	
1.	Non-command area	120	300 - 500
2.	Command area	160	200 - 300
3.	Near perennial source like river or pond (within 200 m)	160	200 - 300
4.	Non-perennial stream	180	300 - 500

Source: NABARD

### Annexure 10 -Recuperation Test for Estimation of Yield of an Open Well

The hydraulics of flow towards open well is slightly different. In the case of tube well, radial flow takes place all around the well and there is no flow from the bottom of the well, while in the case of an open well, all the flow is essentially from the bottom. An open well has relatively large diameter at its base, and its sides are mostly lined with brick. The discharge of an open well can be determined with the help of a recuperation test. In the recuperation test, water level is depressed to any level below the normal level, and the pumping is stopped. The time taken for the water to recuperate to the normal level is noted. From the data, the discharge from the well can be calculated as under:

Let,

aa = static water level in the well, before the pumping started

bb = water level in the well when pumping stopped

h1 = depression head when the pumping stopped (meters)

cc = water level in the well at a time T after pumping stopped

h2 = depression head in the well at a time T after pumping stopped (meters)

h = depression head in the well at a time  $t$  after the pumping stopped (meters)

$dh$  = decrease in depression head in time  $dt$

$t, T$  = time in hours

Thus, in a time  $t$ , reckoned from the instant of stopping the pumping, the water level recuperates by  $(h_1 - h)$  meters. In a time  $dt$  after this, the head recuperates by a value  $dh$  meters.

Volume of water entering the well, When the head recuperates by  $dh$  is  $dV = A dh$

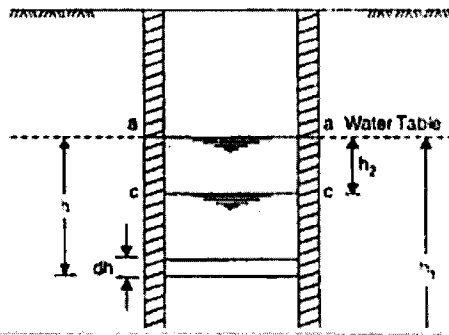

Where  $K$  is constant depending upon the soil at the base of the well through which water enters. Equating (1) and (2), we get  $Khdt = -Adh$ . The minus sign indicates that  $h$  decreases as time  $t$  increases. Integrating the above between the limits

$t=0$  when  $h=h_1$ ; to  $t = T$  when  $h = h_2$

We get 
$$\frac{K}{A} \int_0^T dt = - \int_{h_1}^{h_2} \frac{dh}{h}; \text{ from, } \frac{K}{A} T = [\log e]_{h_2}^{h_1}$$

Or 
$$\frac{K}{A} = \frac{1}{T} \log e \frac{h_1}{h_2} = \frac{2.3}{T} \log 10 (h_1/h_2)$$

Thus, knowing value of  $h_1$ ,  $h_2$  and  $T$  from a recuperation test, the quantity  $K/A$  can be calculated.  $K/A$  is known as the specific yield or specific capacity of an open well, in cubic meter per hour per square meter of the area through which water percolates under one meter depression head. In the absence of the recuperation test, the following rough values of  $K/A$ , specified by Marrio, can be adopted

Type	$K/A$ (cubic meter per hour, per sq m of area under 1m depression head)
Clay	0.25
Fine sand	0.50
Coarse sand	1.00

Knowing the value of  $K/A$  by observations, the discharge  $q$  from a well under a constant depression head  $H$  can be calculated as under:

$$q = KH = \left(\frac{K}{A}\right) AH = \frac{2.3}{T} \left(\log 10 \frac{h_1}{h_2}\right) AH \frac{m^3}{\text{hour}}$$

**Example:** During a recuperation test, the water in an open well was depressed, by pumping, by 2.5 meters and it recuperated 1.8 meters in 80 minutes. Find (a) yield from a well of 4 m diameter under a depression head of 3 meters, (b) the diameter of a well to yield 8 liters/second under a depression head of 2 meters.

**Solution:** The specific yield is given by

$$\frac{K}{A} = \frac{2.3}{T} \log 10 \frac{h_1}{h_2} \text{ where } T = \text{time in hour} = \frac{80}{60} = \frac{4}{3} \text{ hours}$$

$$H_1=2.5\text{m}; h_2=2.5-1.8=0.7\text{m} \quad \therefore \frac{K}{A} = \frac{0.955 \frac{m^3}{m}}{\text{hr}}$$

(a) Yield from the well of diameter 4 m:

$$A = \frac{\pi}{4} (4)^2 = 12.56 \text{ m}^2; q = \left(\frac{K}{A}\right) AH = 0.955 \times 12.56 \times 3 = 36 \frac{\text{m}^3}{\text{hour}} = 10 \text{ L/sec}$$

(b) Yield = 8 lit/sec = 28.8 m<sup>3</sup>/hour (since 1 liter/sec = 3.6 m<sup>3</sup>/hour)

$$\therefore q = \left(\frac{K}{A}\right) AH \text{ or } A = \frac{q}{H} \times \left(\frac{A}{K}\right) = \frac{28.8}{2} \times \frac{1}{0.955} = 15.05 \text{ m}^2$$

$$\therefore d = \sqrt{4 \times \frac{15.05}{\pi}} = 4.37 \text{ m} \approx 4.4 \text{ m (say)}$$



## Annexure 11- Guidelines for Sustainability of Ground Water Sources

### Existing Practices in Ground Water Recharge in Kerala

The Jalanidhi, Government of Kerala has implemented schemes involving several different types of water harvesting structures (depending on the local site conditions).

These include:

- Check Dams
- Percolation Tanks
- Sub-surface Dykes
- Rooftop Rain Water Harvesting Structures
- Infiltration Rings
- Recharge Pits
- Injection Wells and Recharge Wells

### Roof Top Water Harvesting Systems

Roof top water harvesting systems can provide good quality potable water with the design features outlined below are taken into account:

- The substances that go into the making the roof should be non-toxic in nature
- Roof surfaces should be smooth, hard and dense since they are easier to clean and are less likely to the damage and released material / fiber into the water.
- Roof painting is not advisable since most paints contain toxic substances and may peel off.
- No overhanging tree should be left near the roof.
- The nesting of birds on the roof should be prevented.
- All gutter ends should be fitted with a wire mesh screen to keep out leaves etc.
- A first-flush rainfall capacity, such as detachable down pipe section, should be installed.
- A hygienic soak away channel should be built at water outlet and a screened overflow pipe should be provided.
- The storage tank should have a tight fitting roof that excludes light a, manhole cover and a flushing pipe at the base of the tank (for standing tanks).
- There should be a reliable sanitary extraction device such as a gravity tap or a hand pump to avoid contamination of the water in the tank.
- There should be no possibility of contaminated wastewater flowing into the tank (especially for tanks installed at ground level)
- Water from other sources, unless it is reliable source, should not be emptied into the tank through pipe connections or the manhole cover.
- During the rainy season, the whole system (roof catchment, gutters, pipes, screens, first-flush and overflow) should be checked before and after each rain and preferably cleaned after every dry period exceeding a month.

- At the end of the dry season and just before the first shower of rain is anticipated, the storage tank should be scrubbed and flushed all sediment and debris (the tank should be re-filled afterwards with a few centimeters of clean water to prevent cracking).
- Ensure timely service (before the first rain) of all tanks features, including replacement of all worm screened and servicing of the outlet tap or hand pump.

#### Percolation Tanks

- Percolation tanks should normally be constructed in a terrain with highly fracture and weathered rock for speedy recharges; in case of alluvium the bouldary formations are ideal. However, the permeability shouldn't be too high that may result in the percolated water escaping the downstream.
- Submergence area should be uncultivated as far as possible.
- Rainfall pattern based on long-term evaluation is to be studied so that the percolation tanks gets filled up fully during monsoon (preferably more than once)
- Soil in the catchment area should preferably be of light sandy type to avoid silting upon the tank bed.
- The location of the tank should preferably be downstream of runoff zone or in the upper part of the transition zone, with a land slope gradient of 3 to 5%.
- While designed, due care should be taken to keep the height of the ponded water column about 3 to 4.5 m above the bed level. It is desirable to exhaust the storage by February since evaporation losses becomes substantial from February onwards. It is preferable that in the downstream area, the water table it is depth of 3 to 5 m below level during the post monsoon period, impaling that the benefited area possesses a potential shallow aquifer.
- Construction-wise, there is not much difference between a percolation tank and a minor irrigation tank, except for providing outlets for surface irrigation and the depth of the cut-off trench. The cut-off trench is to be provided below the earthen bund with depth limited to one fourth of the height between bed level and full storage level.

#### Check Dams

Check Dams are constructed in the drainage course of narrow streams in low rainfall area to impound run-off rainwater. The following are some guidelines for construction of check dams.

- The total catchment of the nala should normally be between 40 to 100 hectares though the local situations can be guiding factor in this. The rainfall in the catchment should be less than 1000mm/ annum
- The Nala bunds should be preferable located in area where contour or graded bunding of lands have been carried out.
- The rock strata exposed in the ponded area should be adequately permeable to cause ground water recharge through ponded water.

- Nala bund is generally a small earthen dam with cutoff core wall of bricks work, though masonry and concrete bunds/plugs are now prevalent.
- Dams should be built at sites that can produce relatively high depth to surface area so as to minimize evaporation losses.
- Rocky surface should not be fractured or cracked, which may cause the water to leak away to deeper zones or beneath the dam.
- Dam foundation must of solid impermeable rock with no soil pockets or fracture line.
- No soil erosion in the catchment area
- Dams should be site along the edges of depressions or directly across the lower ends of deep gullies into rock.

#### **Ponds/ Tanks**

A good pond should possess the following traits:

- The site should be narrow gorge with a fan shaped valley above: so that amount of earthwork gives a large capacity. Junctions of two tributaries, depressions and other sites of easily available fill material and favorable geology should be preferred
- The capacity catchment ratio should be such that the pond can be filled up to about 2-3 months of rainfall. The capacity should not be too small to be choked up with sediments very soon
- The pond should be located where it could serve a major purpose e.g. if irrigation it should be above irrigated field
- The site should not have excessive seepage losses.
- The catchment areas should be put under conservative practices

#### **Gully plugging, Contour bunds**

The gully plugging measures includes vegetative plantings and brushwood check dams, boulder bunds, brick masonry and earthen bunds or a combination of both, sand bag plugs etc. Contour bunds involve construction of horizontal lines of small earthen or boulder bunds across the sloping land surface.

- Ensure there is no open defecation in/near structure
- No tethering of animals at the site
- There must be no pit-latrines on the bank upstream
- Avoid use of pesticides/chemicals upstream of the site

#### **Rainwater Harvesting Structures**

Guidelines for Implementation of Rainwater Harvesting Structures for Sustainability of Drinking water supply sources:

- The rainwater harvesting (RWH) structures should be site specific closer to the source but 15 m away from the bore well to prevent direct contamination; the location should be certified by the hydro geologist of the KRWSA department.



- The local geological and hydro geological conditions have to be studied in conjunction with the location of the groundwater source to facilitate maximum recharge from the structure.
- No RWH structure should be installed in the supply feeder channel of tanks.
- RWH structure should be simple and suitable to the location and economically viable to the community.
- All the works of RWH structure should be implemented before the onset of the monsoon.
- Pre and post water level and water quality monitoring should be carried out in the well for water supply source to evaluate the benefit accrued of the RWH structures.

#### **Erosion control in catchment**

There is no unique solution for erosion control. The following are some of the erosion control measures used in many parts of the country.

1. **Conservation cover:** Establish and maintain perennial vegetative cover to protect soil and water resources.
2. **Contour bunding trenching:** Forming contour bunding or trenching along the contour in steep sloped areas may be taken up for reducing runoff and erosion. Terraces are constructed with earthen embankments that retard runoff and reduce erosion by breaking the slope into numerous flat surfaces separated by slopes that are protected with permanent vegetation.
3. **Critical area planting:** Planting vegetation such as trees, shrubs, grasses or legumes on highly erodible or eroding areas. While undertaking any plantation programme care must be taken to plant only indigenous species with involving and close coordination with local people

### Annexure 12 -Disinfection of Water

Raw water container can incorporate one or several filter elements depending on the flow required. The filters can also operate by siphon action as shown in **Figure 1**. Complete unit of upper and lower containers and filter elements can be purchased. Always order spare filter elements as they need replacing after long or heavy use. Spare filter elements can also be used to filter water in combination with a plastic bucket for the upper container and a jerry can for the filtered water.

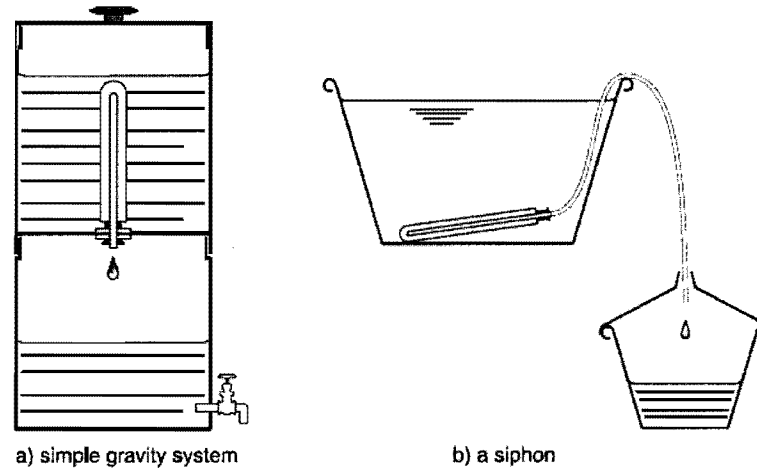

Figure 1 - Ceramic candle filters

After some time the water flow diminishes as the candle becomes coated by the filtered out particles. The accumulated slime is cleaned off with a nylon brush in a bucket of water. Each brushing removes part of the ceramic candle so that the diameter of the candle is gradually reduced. A circular gauge should come with each filter – try not to lose it! The filter element needs replacing if the gauge can be slipped over the candle. Silver acts as a bactericide, and candles are available which are silver impregnated for added protection.

#### Disinfection by chlorine

Disinfection kills pathogenic organisms. It can be achieved by a variety of physical and chemical means. This section deals with the method most widely used in emergencies, chlorination. Some information is also given on two other methods: the use of iodine and boiling. Chlorine is the most readily available and widely used chemical disinfectant for water supply. The aim of chlorination is the destruction of pathogens and the protection of the water supply. To achieve this, a chlorine dose must be sufficient to:

- Meet the chlorine demand of the water, that is, it must oxidize the contaminants (including reacting with any organic or inorganic substances).
- Leave a residual, in order to give protection against further contamination. This is achieved by ensuring a free residual of 0.2–0.5 mg/l of chlorine in the

disinfected water, which inhibits any subsequent growth of organisms within the water supply system. Higher residuals may give an unpleasant taste. A pre-condition for effective chlorination is that the turbidity of the water must be low.

In an emergency water supply the aim is to have a turbidity of less than 5 NTU. Chlorination will function relatively effectively up to 20 NTU, but steps should be taken to reduce turbidities as soon as possible. At high turbidity levels, large quantities of chlorine are needed to oxidize the organic matter present. This leaves a strong chlorine taste which may cause people to use other, possibly contaminated, sources of water for drinking. Furthermore, some pathogens inside particles of organic matter may survive the oxidizing effects of the chlorine.

**Chlorine may be added to a water supply by**

- Dosing with a continuous flow of a one per cent solution of chlorine
- Adding chlorine tablets or powder directly to a tank of water (for emergency chlorination only).

**Advantages**

- It comes in several forms: powder, granules, liquid, and gas.
- It is usually readily available and relatively cheap in one form or another.
- It dissolves easily.
- Residual chlorine remaining in treated water provides some protection against further contamination.
- It is effective against a wide range of pathogens

**Disadvantages**

- It is a powerful oxidizing agent which must be handled carefully – do not breathe chlorine fumes.
- It does not effectively penetrate particulate matter.
- It can give an unpleasant taste when slightly overdosed, which could dissuade people from drinking safe water.
- Its effectiveness against some pathogens – cysts, ova, viruses – requires higher chlorine concentrations and a longer contact time.

**Chlorination - Necessity**

Drinking polluted water can result in a reduction in immunity or resistance to disease, either because the chlorine affects the flora in the stomach or because the absence of pathogens in the water lowers subsequent immunity. There is no evidence that any low level of residual chlorine that survives to the point of consumption is harmful. As an oxidizing agent, residual chlorine will react quickly with organic matter and it is therefore unlikely to survive long in the contents of the stomach (in which there are, in any case, high levels of naturally occurring hydrochloric acid). Current evidence suggests that there is very little likelihood that the absence of pathogens will have any effect on immunity to disease. Therefore, in crowded emergency situations, chlorination of the water supply is strongly recommended. In other disaster situations, especially

where populations are dispersed, chlorination of supplies may not be a priority. The decision on whether or not to chlorinate a water supply does not concern immunity. It concerns the balance of feasibility, cost and benefit to the health of the community as a whole (Feachem, 1993).

**How much chlorine is required?**

Enough chlorine must be provided to meet the chlorine demand and to leave a free residual of 0.2–0.5 mg/l (WHO, 1984) after a contact time of 30 minutes. Chlorine residuals are of two kinds, combined residuals and free residuals. Combined residual chlorine is the proportion of the original chlorine dose which combines with ammonia and organic nitrogen compounds to form stable but less effective disinfectants than free chlorine. Free residual chlorine is that part of the chlorine dose which remains after the chlorine demand has been fully satisfied. The actual dose will depend on the condition of the water. It can be expected to be in the range, 1–5 mg/l. Determine the optimum dose by trials on water samples. To determine how much chlorine is required, it is necessary to analyze the water for the chlorine residuals. Simple colour comparator kits with reagents are available to indicate the free and combined residuals of chlorine in water. The colour comparator shown in Figure 2 is used to indicate both chlorine residuals and pH concentrations.

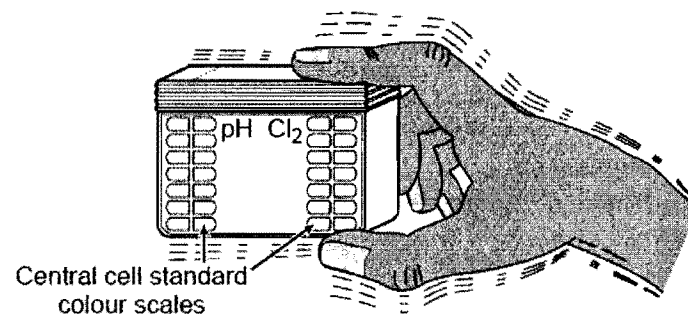

Figure 2 Colour comparator

**Water treatment using chlorine**

Chlorine in water will form hypochlorous acid (HClO), at low pH values, or tend to dissociate into hydrogen (H+) and chlorite (ClO-) ions at higher pH values. Hypochlorous acid is the more active disinfectant and therefore chlorination is more effective in low pH (acidic) water. Chlorination is considerably less effective when the pH is greater than 8. Disinfection using chlorine takes longer in cold than in warm water. Therefore, a normal contact time of 30 minutes may need to be increased to one hour. This implies that chlorination tanks may need to be increased in size or number to obtain the residence time for a particular throughput.

Ensure all Chlorination tests are conducted on samples that are at the correct temperature. For example, test samples in the outside temperature, not in a warm office or laboratory! The following gives a sample calculation for the chlorine requirement for a continuous process water supply system supplying a large community.



### Calculation of chlorine requirement

Task: to calculate how much chlorine is needed to chlorinate a water supply for 20000 people receiving 15 litres/person/day of chlorinated water. Water demand = 300000 litres

If water is supplied by pump at a flow rate of 8 l/s then the total pumping time is about 10.5 hours/day. In this case the water is of medium quality requiring a dose of 3mg/l of active chlorine to give a residual of 0.2 mg/l. This information was obtained by dosing small samples and analyzing using a test kit. For a pumping rate of 8 l/s the dosing rate must be  $3 * 8 = 24$  mg/s. Using a 1% chlorine solution, which contains 10 g chlorine/litre: the rate of application required will be  $(24/1000) * (100/1) = 2.4$  g/s (ml/s) or 144 ml/minute.

For 10.5 hours pumping per day the amount of 1% chlorine solution required =  $144 * 60 * 10.5/1000 = 90.7$  litres/day. Therefore, a 200-litre drum of 1% chlorine solution would last two days.

### Forms of chlorine

Chlorine is available in the following forms:

- Chlorine gas is normally used in conventional water supply schemes of substantial size. Chlorine gas dosing equipment is expensive to install, complicated to operate and maintain, and it can be dangerous if not handled properly. Chlorine gas is unlikely to be used in an emergency water supply.
- High Test Hypochlorite (HTH) – calcium hypochlorite granules supplied in drums (70% available chlorine).
- Sodium hypochlorite – supplied in liquid form as:
  - a) Household disinfectant (Chlorox, Parazone, Domestos, etc.) 5–15% available chlorine.
  - b) Laundry bleaches 3–5% available chlorine.
  - c) Antiseptic solutions (Milton, Javel) 1% or 2% solution.
- Electrolytic generators are available which generate sodium hypochlorite from common salt. They are powered by electricity from mains AC or solar photovoltaic cells.
- Bleaching powder or chlorinated lime – about 30 per cent available chlorine when fresh.
- Chlorine tablets – various relatively expensive types:
  - a) Small calcium hypochlorite tablets (60–70 per cent available chlorine) used in tablet chlorinators.
  - b) ‘Swimming pool’ tablets containing trichloroisocyanuric acid: these tablets can be suspended in a tank with a purpose-made float to give a slow release of chlorine.

- c) Antiseptic solutions (such as Milton or Javel) are usually of one per cent (or two per cent) concentration. If chlorine is required in bulk, it is more economical to make up a one per cent solution from stronger solutions.

**Making a 1 per cent chlorine solution**

A comparatively stable working solution is of 1 per cent available chlorine. This can be used to dose water in a water treatment plant. A 1 per cent solution contains 10 g of chlorine per litre, i.e. 10 000 mg/litre or 10 000 ppm (parts per million).

Small quantities of 1 per cent solution are suitable for dosing supplies to service centres such as clinics, and for relief worker compounds. Take care when mixing bleaching powder, as it will form lumps if simply added to water. Add just enough water to the powder to form a cream. Use a wooden stirrer and gradually add water to make the required solution. Allow the sediment which forms to settle and decant the liquid before use. Table 1 is an approximate guide to make 1 litre of a 1 per cent solution from various sources. Remember that if the chlorine source has been stored for some time, its strength will have reduced.

**Table 1 Preparation of 1 Litre of 1 percent chlorine solution**

Chlorine Source	Available Chlorine %	Quantity required	Approx measure
High Test Hypochlorite (HTH) granules	70	14 g	1 heaped tablespoon
Bleaching powder	34	30 g	2 heaped tablespoons
Stabilized tropical bleach	25	25 g	3 heaped tablespoons
Liquid household disinfectant	10	10 g	7 tablespoons
Liquid laundry bleach	5	5 g	14 tablespoons
Antiseptic solution (eg : Milton)	1	1 g	No need to adjust as it is a 1 % solution

**Table 2 Water treatment**

Container size	1 gallon (4.5 L)	20 L	45 gallon drum (200 L)
Volume of 1 % solution required	8 drops	Half-teaspoon	1 table spoon + 1 tea spoon

Guide based on the approximate measures: 1 teaspoon = 5 ml, 1 tablespoon = 15 ml.

**Storage and handling**

Both the liquid and powdered forms of chlorine reduce in strength over time, especially once containers are opened. Therefore, store dry chlorine in sealed containers, away from heat and out of sunlight, and keep liquid solutions in dark colored bottles. Chlorine is corrosive – handle with care, avoid skin contact and, when

mixing a chlorine solution, wear protective clothes and gloves, protect the eyes and do not breathe the fumes.

#### Some other methods of disinfection

##### *Iodine*

Iodine is an effective bactericide and kills spores, cysts and viruses. The recommended dose is 2 mg/l with a contact time of 30 minutes (WHO, 1989). It appears to be more effective than chlorine in penetrating suspended solids in water. This may be significant in an emergency in the absence of pretreatment, and where iodine is available for small-scale use in clinics, etc. However, iodine is not appropriate for large scale use as it is far more expensive than chlorine and not so widely available.

##### *Boiling*

*Boiling* is an effective physical method of complete sterilization. It is more reliable than chemical disinfection as it will destroy pathogens within suspended particulate matter. However, there are significant disadvantages:

- Energy is required to boil the water (about 1 kg of wood is needed to boil 1 litre of water).
- Boiling must continue for 5–10 minutes.
- Boiled water is de-aerated and has a flat, unattractive taste.
- There is a delay between boiling and cooling before the water can be drunk.
- There is nothing to hinder post-boiling re-contamination through poor handling and storage.
- It is only practical for small quantities of water.

##### *Chemical dosing equipment*

Methods for the dosing of liquid chlorine and coagulant solutions fall into the following categories:

- Batch dosing to a fixed volume of water.
- Constant rate dosing into water flowing at a steady rate.
- Proportional dosing at a rate proportional to a variable flow rate.

Figure 3 shows an improvised, gravity fed, constant rate method of chlorine dosing. The dose rate from the floating bowl is controlled by the driving head to the glass jet, which is controlled by the weight of the floating bowl. This driving head, and hence the dosing rate, may be adjusted by adding or removing stones from the floating bowl.

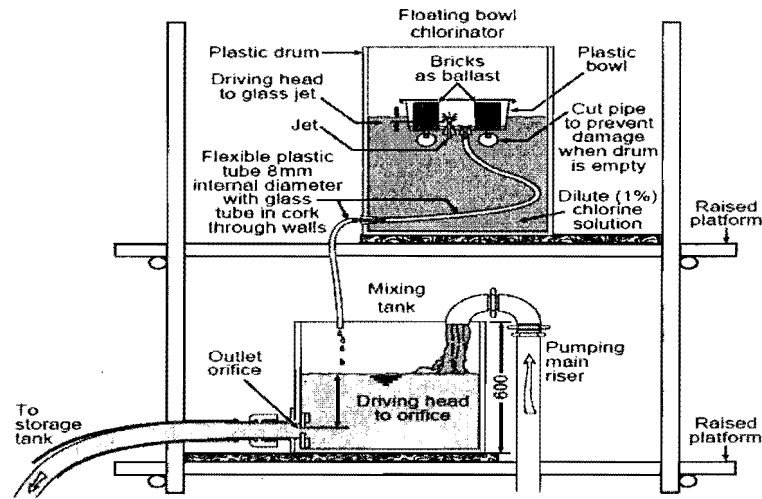

Figure 3 - Gravity fed, constant rate chlorine solution dosing

The displacement doser (Figure 4) is a common method of proportional dosing used for small-scale community and institution supplies (such as hospitals). The differential pressure created across the orifice (or alternatively a venturi) displaces solution from the flexible bag and injects it into the flow.

A displacement doser needs skilled operation and maintenance. Portable treatment units generally consist of a water pump, a filtration unit and a method of chlorine dosing. Each section of the package may be supplied as a module, for ease of handling and independent use, or supplied as a self contained unit for mounting on a trailer or skid. Typical capacities range from 2 to 22 m<sup>3</sup>/h. Larger units are installed in standard freight (ISO) containers.

When ordering, obtain guideline operational data from the supplier so that sufficient consumables (chemicals and fuel) can be ordered in advance. Disinfection may be by super chlorination. The addition of a large dose of chlorine can rapidly disinfect water without the need for a long residence time. Excess residual chlorine is removed by a carbon filter and the water is then ready for immediate supply. A carbon filter may also remove bad tastes and odours.



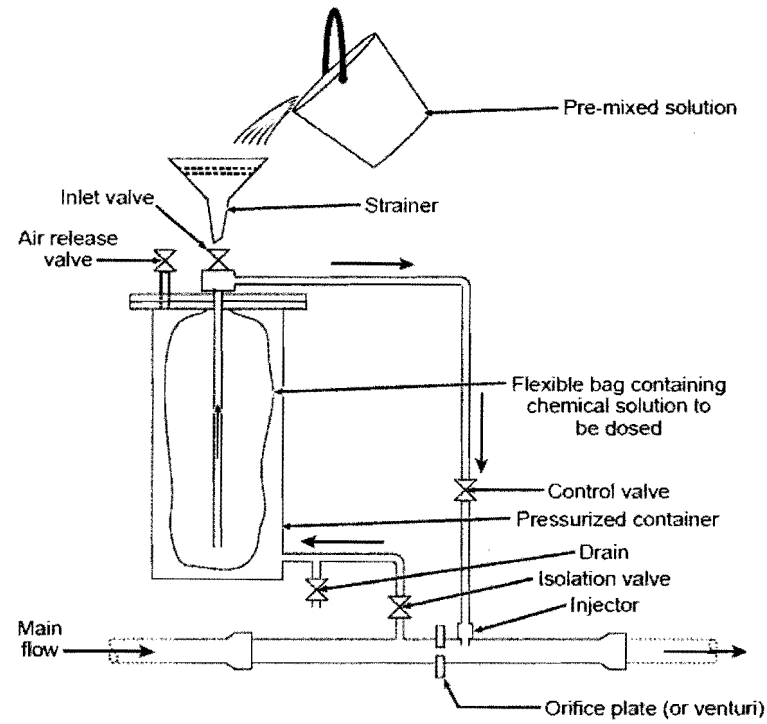

**Figure 4 Displacement Doser**

***Packaged water treatment plant***

Portable packaged plants may be suitable in certain cases where appropriate expertise and a supply of consumables (fuel and chemicals) are available. They have been used to supply relief personnel during the installation of a larger system for the population as a whole. They are not normally appropriate for supplying water to large populations.

### Annexure 13 -Sanitary Protection of Wells and Springs

The annular open space on the outside of the well casing is one of the principal avenues through which undesirable water and contamination may gain access to a well. The most satisfactory way of eliminating this hazard is to fill the annular space with neat cement grout. To accomplish this satisfactorily, careful attention should be given to see that

1. The grout mixture is properly prepared.
2. The grout material is placed in one continuous mass.
3. The grout material is placed upward from the bottom of the space to be grouted.

Neat cement grout should be a mixture of cement and water in the proportion of 1 bag of cement and 20 - 25 liters of clean water. Whenever possible, the water content should be kept near the lower limit given. Hydrated lime to the extent of 10 per cent of the volume of cement may be added to make the grout mix more fluid and thereby facilitate placement by the pumping equipment. Mixing of cement or cement and hydrated lime with the water must be thorough. Up to 5 per cent by weight of bentonite clay may be added to reduce shrinkage.

#### Grouting Procedure

The grout mixture must be placed in one continuous mass; hence, before starting the operation, sufficient materials should be on hand and other facilities available to accomplish its placement without interruption.

Restricted passages will result in clogging and failure to complete the grouting operation. The minimum clearance at any point, including couplings, should not be less than 4 cm. When grouting through the annular space, the grout pipe should not be less than 2.5 cm nominal diameter. As the grout moves upward, it picks up much loose material such as results from caving. Accordingly, it is desirable to waste a suitable quantity of the grout which first emerges from the drill hole.

In grouting a well the material will move upward, there are two general procedures that may be followed. The grout pipe may be installed within the well casing or in the annular space between the casing and drill hole if there is sufficient clearance to permit this. In the latter case, the grout pipe is installed in the annular space to within a few cm of the bottom. The grout is pumped through this pipe, discharging into the annular space, and moving upward around the casing, finally overflowing at the land surface.

In 3 to 7 days the grout will be set, and the well can be completed and pumping started. A waiting period of only 24 to 36 hours is required if quick-setting cement is used. When the grout pipe is installed within the well casing, the casing should be supported a few cm above the bottom during grouting to permit grout to flow into the annular space. The well casing is fitted at the bottom with an adapter threaded to receive the grout pipe and a check valve to prevent return of grout inside of the casing. After grout appears at the surface, the casing is lowered to the bottom and the grout pipe is unscrewed immediately and raised a few cm. A suitable quantity of water should then be pumped through it, thereby flushing any remaining grout from it and the casing. The grout pipe is then removed from the well and 3 to 7 days are allowed for setting of



the grout. The well is then cleared by drilling out the adapter, check valve, plug, and grout remaining within the well.

A modification of this procedure is the use of the well casing itself to convey the grout to the annular space. The casing is suspended in the drill hole and held a few meters off the bottom. A spacer is inserted in the casing. The casing is then capped and connection made from it to grout pump. The estimated quantity of grout, including a suitable allowance for filling of crevices and other voids, is then pumped into the casing. The spacer moves before the grout, in turn forcing the water in the well ahead of it. Arriving at the lower casing terminal, the spacer is forced to the bottom of the drill hole, leaving sufficient clearance to permit flow of grout into the annular space and upward through it.

After the desired amount of grout has been pumped into the casing, the cap is removed and a second spacer is inserted in the casing. The cap is then replaced and a measured volume of water sufficient to fill all but a few feet of the casing is pumped into it. Thus all but a small quantity of the grout is forced from the casing into the annular space. From 3 to 7 days are allowed for setting of the grout. The spacers and grout remaining in the casing and drill hole are then drilled out and the well completed.

If the annular space is to be grouted for only part of the total depth of the well, the grouting can be carried out as directed above when the well reaches the desired depth and the well can then be drilled deeper by lowering the tools inside of the first casing. In this type of construction, where casings of various sizes telescope within each other, a seal should be placed at the level where the telescoping begins, that is, in the annular space between the two casings. The annular space for grouting between two casings should provide a clearance of at least 4 cm and the depth of the seal should be not less than 3 m.

#### **Spring Development and Protection**

Source of most springs is rainfall that seeps into the ground uphill from the spring outlet. A spring is a place on the earth's surface where groundwater emerges naturally. The water while springs may seem like an ideal water supply, they need to be selected with care, developed properly, and tested periodically for contamination. Spring water moves downhill through soil or cracks in rock until it is forced out of the ground by natural pressure. The amount, or yield, of available water from springs may vary with the time of year and rainfall. Groundwater obtained from springs is similar to water pumped from shallow wells. Like shallow wells, springs may be contaminated by surface water or other sources on or below the ground surface. Springs are susceptible to contamination because the water feeding them typically flows through the ground for only a short distance, limiting the amount of natural filtering that can occur. Springs may not be a good choice for a water supply if the area uphill where the water collects is used for industry, agriculture, or other potential sources of pollution.

#### **Spring Development**

Proper *spring development* helps protect the water supply from contamination. The objective of spring development is to collect the flowing water underground to protect it from surface contamination and store it in a sanitary spring box. Proper development depends on whether the spring is a concentrated spring or a seepage spring.



**Concentrated springs** occur along hillsides in mountain and piedmont areas at points where groundwater emerges naturally from openings in rock (Figure 1a). These are the easiest springs to develop and protect from contamination. Proper development for concentrated springs consists of intercepting water underground in its natural flow path before it reaches the land surface. One type of concentrated spring found in valleys or other low areas is termed a *low-area spring* (Figure 1b). Low-area springs are not as easily protected as those located in higher areas where other surface water naturally drains away from the spring.

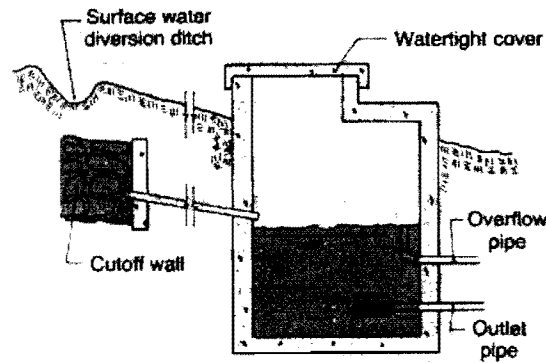

Figure 1a. Cut-away view of a concentrated spring.

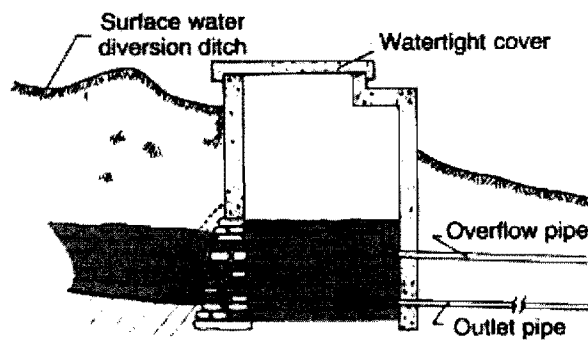

Figure 1b. Cut-away view of a low-area spring.

**Seepage springs** occur where groundwater "seeps" from the soil over large areas (Figure 2a). The development process for seepage springs consists of intercepting flowing groundwater over a wide area underground and channeling it to a collection point. Because seepage springs collect water over large areas, they are more difficult to protect from surface water contamination than concentrated springs.

To develop a **concentrated spring** the following steps have to be taken. (Figures 1a and 1b):

1. Dig upslope from the spring outlet to a point where flowing water is at least 3 feet underground or where rock is encountered.

2. Install a rock bed to form an interception reservoir. On the down slope side, install a *cutoff wall* of concrete or plastic. The cutoff wall may not be necessary for a low-area spring, where the spring box may serve as the collector.
3. Insert a *collector pipe* low in the cutoff wall to guide water into the spring box. As much as possible, prevent water from backing up behind the wall.

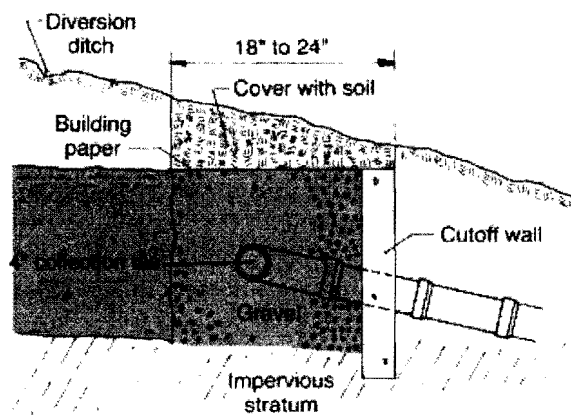

Figure 2a. Cut-away view of a seepage spring.

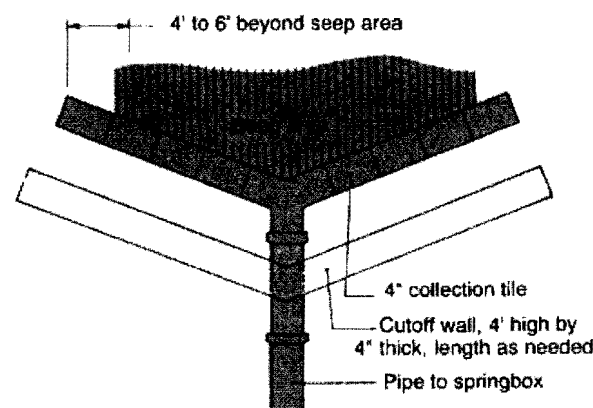

Figure 2b. Overhead view of a seepage spring.

Follow these steps to develop a *seepage spring* (Figures 2a and b):

1. Dig test holes uphill from the seep to find a point where the impervious layer below the water-bearing layer is about 3 feet underground. Water flows on top of this layer in sand or gravel toward the surface seep.
2. Dig a 2-foot-wide trench across the slope to a depth of 6 inches below the water-bearing layer and extending 4 to 6 feet beyond the seep area on each side. Install a 4-inch *collector tile* and completely surround the tile with gravel.
3. Connect the collector tile to a 4-inch line leading to the spring box. The box inlet must be below the elevation of the collector tile.

The *spring box* should be watertight (most are made of reinforced concrete) and have a tight-fitting "shoebox" cover. It should be at least 4 feet tall and should extend at

least 1 foot above ground level when buried. The size of the spring box depends on the amount of storage needed. Typically, it should be at least 3 feet square, which would provide storage of 135 gallons with water standing 2 feet deep. If the size were increased to 4 feet square, the amount of storage would increase to 240 gallons with water standing 2 feet deep.

The spring box should have an *outlet pipe* and an *overflow pipe*. The overflow pipe should be screened and located below the collector pipe or tile so that water will not back up behind the spring. The overflow may be a floating device connected to the outlet pipe. Install a drain for cleaning the box.

#### Spring Protection

Springs are susceptible to contamination by surface water, especially during rainstorms. Contamination sources include livestock, wildlife, crop fields, forestry activities, septic systems, and fuel tanks located upslope from the spring outlet. Changes in color, taste, odor, or flow rate indicate possible contamination by surface water. To protect springs you can take the following measures.

1. Divert all surface water away from the spring as far as possible. Do not allow flooding near the spring.
2. Construct a U-shaped surface drainage diversion ditch or an earth berm at least 50 feet uphill from the spring to divert any surface runoff away from the spring. Be careful not to dig deep enough to uncover flowing groundwater. Prevent pounding in the diversion ditch.
3. Construct an earth berm adjacent to the spring or a second U-shaped diversion ditch lined with concrete tile for added protection.
4. Fence an area at least 100 feet in all directions around the spring box to prevent contamination by animals and people who are unaware of the spring's location.
5. Avoid heavy vehicle traffic over the uphill water bearing layer to prevent compaction that may reduce water flow.

#### Water Testing

Most spring contamination results from poor spring development construction of from direct flow of surface water into the shallow groundwater feeding the spring. Spring water should be tested before and after heavy rains each year for bacteria, pH, turbidity, and conductivity to determine if surface-water contamination is a problem. If water levels change frequently when it rains, the spring is very susceptible to contamination. If bacteria are found at any time in the water, properly disinfect the system and retest the water before using it again.

Springs are susceptible to contamination by Giardia, Cryptosporidium, and other microorganisms that are not detected by standard bacterial tests. Test for these microorganisms if spring water is suspected as a source of illness.

#### Spring Disinfection

Springs are often contaminated with bacteria during construction or maintenance. All new and repaired water systems should be disinfected using *shock chlorination*. If bacterial contamination occurs on a regular basis because of surface sources above the spring, *continuous chlorination* may be necessary.

Shock chlorination requires concentration of at least 200 parts per million (ppm) chlorine. (As a point of reference, 200 ppm is the same proportion as 1 pound of salt in about 600 gallons of water.) To obtain this concentration, add 3 pints of liquid chlorine laundry bleach (such as "Chlorox," which is about 5 percent chlorine) *for each 100 gallons of water* to be disinfected. Other sources of chlorine are 1 pint of swimming pool disinfectant or concentrated bleach (at 12 to 17 percent chlorine) per 100 gallons of water or 4 ounces of high-test calcium hypochlorite tablets or powder (at 65 to 75 percent chlorine) per 100 gallons of water.

Follow these steps to disinfect spring-fed water systems with chlorine:

1. Remove debris and sediment from the spring box and distribution system. Scrub all interior surfaces with a strong chlorine solution (1 gallon of liquid chlorine laundry bleach per 10 gallons of water). Be sure to wear gloves and other appropriate protective clothing
2. Disinfect the spring box by first allowing it to fill with fresh spring water. If the spring flow is small enough, plug the outlet pipe and add chlorine to the spring box to obtain the 200-part-per-million chlorine concentration as described above. Hold the chlorinated water in the spring box for at least 12 hours. Keep the overflow pipe open. If the flow rate is too high to retain water in the spring box, feed the chlorine solution into the spring box continuously for at least 12 hours.
3. Disinfect the water distribution system including pressure tanks, storage tanks, pipelines, valves, and faucets by pumping chlorinated water through the system. Open all faucets until a strong chlorine odor is detected at each one. Close the faucets to allow the chlorine solution to remain in the system for at least 12 hours.
4. Open all valves and faucets to allow fresh spring water to flow through the system until no chlorine odor or taste can be detected.
5. Test the spring water for bacterial contamination 24 hours after chlorine has been removed from the spring and household system.

*Continuous chlorination* is necessary if bacterial contamination continues after repeated shock chlorination. In this system, equipment is used to feed chlorine continuously in sufficient amounts to kill bacteria. Chlorine must be in contact with water at least 1 to 5 minutes to kill all bacteria. At the end of this time, a *chlorine* residual of about 3 to 5 ppm should remain to indicate that the disinfection is complete. Typical chlorine feed rates are about 1 cup of 5 percent laundry bleach per 300 gallons of water. This rate depends on water temperature, pH, and pumping rate. Use an inexpensive chlorine residual kit to determine if the feed rate should be increase or decrease to obtain the proper chlorine residual.

### Annexure 14- Mitigation Measures for Fluoride Contamination

#### Effects of excess fluoride in water

Excessive fluoride >1.5 mg/L in drinking water may cause dental fluorosis, a condition resulting in the discoloration of the enamel, with chipping of the teeth in severe cases, particularly in children. With higher level of fluorides >3 mg/L, skeletal fluorosis with its crippling effects is observed. Non-skeletal and allergic manifestations of fluorosis can also occur. The effects of fluorosis are irreversible and there is no treatment. Avoiding excessive intake of fluoride can help in prevention.

Fluorides are present mostly in ground water and high concentrations have been found in Kopanur in Chittoor taluk, Chinnamoolathara, Eruthenpathy, Anakatti and Vannamada of Palakkad district and Alappuzha of Kerala.

#### Strategy for mitigation

When high levels of fluoride are detected in local ground water, the ideal course of action to take would be:

1. Using alternate water sources.
2. Improving the nutritional status of the population at risk.
3. Removing excess fluoride (defluoridation).

#### Removing excess fluoride (defluoridation)

The following table gives an overview of the various defluoridation technologies that have been implemented in Kerala.

Defluoridation Technologies

Defluoridation Process	Principle	Advantages	Limitations
Activated Alumina	Adsorption	<ul style="list-style-type: none"> <li>• Removes fluoride up to 90%.</li> <li>• Treatment is cost-effective</li> </ul>	<ul style="list-style-type: none"> <li>• Sensitive to pH fluctuations, TDS, presence of other elements, etc.</li> <li>• Regeneration is needed every 4-5 months.</li> <li>• Effectiveness reduces with each regeneration.</li> <li>• Disposal of fluoride sludge is a problem.</li> </ul>
Nalgonda Technique	Coagulation and precipitation using alum and lime	<ul style="list-style-type: none"> <li>• Does not involve regeneration of media.</li> <li>• Employs chemicals which are readily available.</li> <li>• Colour, odour, turbidity, bacteria &amp; organic contaminants are also removed.</li> </ul>	<ul style="list-style-type: none"> <li>• Removes only 18-33% of Fluoride.</li> <li>• Regular analysis of feed and treated water is required to calculate the correct dose of chemicals to be added, because water quality changes with time and season.</li> <li>• High maintenance costs.</li> <li>• Large space requirement for drying of sludge.</li> </ul>





Defluoridation Process	Principle	Advantages	Limitations
RO membrane process	Physical filtration through semi permeable membrane	<ul style="list-style-type: none"> <li>Fluoride removal (up to 98%) and disinfection are achieved simultaneously.</li> <li>Low maintenance &amp; regeneration requirements.</li> </ul>	<ul style="list-style-type: none"> <li>Expensive.</li> <li>Nearly all ions are removed so demineralization and pH correction may be needed.</li> <li>Lot of waste brine water is generated and its disposal poses a problem.</li> </ul>
Bone Charcoal	Adsorption	<ul style="list-style-type: none"> <li>Efficiency of the material in fluoride removal is independent of raw water characteristics such as hardness and alkalinity.</li> </ul>	<ul style="list-style-type: none"> <li>There is no technology to regenerate used bone char, so the material must be replaced periodically</li> </ul>

#### Recommended Strategy for Fluoride Mitigation

In any attempt to mitigate fluoride contamination, it is recommended that the provision of safe, low fluoride water from alternative sources, either as an alternative source or for blending, should be investigated as the first option.

The following table presents the available options for fluoride affected villages and the situation for which they seem appropriate.

#### Recommended Options for Fluoride Affected Villages

Available options	Situation for which the option seems appropriate
Alternate local / distant ground water source (with appropriate ground water recharge arrangements)	Where isolated small number of habitations are affected
Local distant surface source	Where large number of contiguous villages are affected
Blending with non-fluoride water	Where fluoride concentration is marginally higher (1.5-2 mg/l) and fluoride free water is available.
Dual supply with different service level (drinking, cooking and other purposes)	Where community is aware and able to distinguish the difference (on pilot basis)

### Annexure 15- Selection of Safe Sanitation Technologies

Selection and installation of safe sanitation technologies to suit the local soil characteristics and hydrogeology is necessary so as to minimize ground water contamination.

For selecting the most appropriate system for any location the following factors are to be considered:

- Number of people to be served
- Per capita water supply rate and the water availability for ablution and flushing
- Extent of space available within the plot street for sanitation facility
- Hydro geologic characteristics of the subsoil
- Depth to groundwater table from the ground surface (summer and rainy season)
- Quality of groundwater in the vicinity and their present uses
- Locations of the existing water supply wells

**Table 1 -Different Types of Sanitation Technologies**

Latrine Type	Suitable for high Ground Water table	Suitable for areas prone to floods, tidal floods or flushes	Suitable for loose soils	Suitable for soils of low permeability	Water requirement	Ease of construction	Ease of maintenance	Remarks
Direct Single Pit Latrine Without Pour flush	Yes, if raised	Yes, if raised	Yes, if Fully clay soils lined	Not for	No	Easy	Easy	Sludge unsafe
Direct Twin Pit Latrine Without Pour flush	Yes, if raised	Yes, if raised	Yes, for fully lined	Not for clay soils	No	Easy	Easy	Safe sludge
Offset Single Pit Latrine with Pour-flush	Yes, if raised and with soak away	Yes, if raised	Yes, for Fully lined	Yes, with soak away	Yes	Easy	Easy	Sludge unsafe
Offset Twin Flush Pit Latrine raised and with Pour flush	Yes, if raised and with soak away	Yes, if raised	Yes, for Fully lined	Yes, with soak away	Yes	Fairly easy	Fairly	Safe sludge easy
Solar heated single-vault eco-sanitary latrine with urine separation	Yes	Yes	Yes	Yes	No	Easy	Difficult	Safe dehydrated material
Single-vault eco-sanitary latrines with urine separation	Yes	Yes	Yes	Yes	No	Easy	Difficult	Safe dehydrated material
Urinal	Yes	Yes	Yes	Yes	Yes a bit	Easy	Easy	-

Considering the various sanitation options available and the factors to be considered, the following on-site sanitation options are recommended as suitable sanitation for the rural habitations:

- Two-pit pour-flush toilet (TPPT)
- Composting toilet or eco-sanitation (Eco-san)

The SOs should play a crucial role in facilitating the choice of appropriate sanitation system for the site specific situation.

Environmental consideration in Location of Toilets	
Specific topic on which information/ data is needed	Considerations
<b>Type of soil stability</b>	
Loose, sides of wall collapse	Line the pits. In sandy soils, sink cement rings that are perforated or set on top of each other without cement.
Hard to dig	Use the pits. In sandy soils, sink cement rings that are perforated or set on top of each other without cement.
<b>Permeability (how water is absorbed by soil)</b>	
Clay soil	Test by pouring water into a hole and measure the time how long it takes to be absorbed. Pits in dense clay may need back filling about 1.2 meters with more sandy soil.
Coarse sand	Back fill around the rings with denser soil and or locate the latrine pipes far away, (for example, 40 meters or more) from a well used for drinking.
Hard	If there might be cracks in the latrine, the latrine pits can pollute nearby drinking water sources. Place the latrine far from these sources.
<b>Ground water level in wet season (deepest level)</b>	
Water rises higher than one meter from bottom of the latrine pit,-but never completely floods the latrine pits	Locate the latrine pit far away from any well used for drinking purpose (for example, 40 meters or more)
Water rises to or above the ground level and sludge comes out the latrines	Raise the latrines above the ground level so that the top of the pit is always above the water level. Place latrines far from drinking water source.
<b>Distance to Water sources</b>	
Distance from latrine pit to drinking water sources	At least 15 meters

## Annexure 16 -Recommended Construction Practices for Twin Pit Pour Flush Latrines

### Construction of Pits

#### 1. Pits in Water logged, Flood Prone and High Sub-soil Water Areas

In high sub-soil, water logged or flood-prone areas, the pits should be raised above the ground level to a height such that the invert of the incoming drains pipes is just above the likely flood water or sub-soil water level. Raising the pipes will necessitate raising the latrine floor also.

In pits located in water logged or flood prone areas, earth should be filled and well compacted all around the pits in 1000 mm width and up to the top. It is not necessary to raise the pits by more than 300 mm above the plinth of the house. In these situations, the pits should be designed as wet pits, taking into consideration the infiltration rate of the type of soil.

#### 2. Pits in Rocky Strata

In rocky strata with soil layers in between, leach pits are designed on the same principles as those for low sub-soil water level taking the infiltration capacity of the soil as 20 litres per sq.m per day. However, in rocks with fissures, chalk formations, or old root channels, pollution can flow over a very long distance; hence these conditions demand careful investigation and adoption of pollution safeguards. In impervious rocky strata the pits will function as holding tanks since there will be no infiltration of liquid. In such situations, a PF latrine with leaching pits is not a suitable system.

#### 3. Pits in Soils with Low Infiltration Capacity

Leaching capacity tends to be the limiting factor when the infiltration capacity of soil is low.

In these circumstances, there are two options: construct a larger pit, or increase the critical leaching area by backfilling and compacting with brick ballast, gravel, sand etc., for the required width all around the pit.

### Emptying of Pits/Septic tanks

Emptying of pits becomes essential when they get filled. The three most important issues related to emptying of pits are frequency, cost, and hygiene. Manual methods of emptying are common for pour-flush latrines. The responsibility for emptying latrines is with the users. The main guidelines relating to latrine emptying include

- Advising householders that the filling/emptying cycle is likely to be between three to six years and that they need to make their own arrangements for emptying the pits.
- Emptying costs are location-specific; anticipated emptying costs should be ascertained with local contractors during programme planning.

### Operation and Maintenance – DO's and Don'ts of Twin-pit Pour-flush Latrines:

#### DO's

- Keep a bucket full of water outside the toilet.
- Keep 2 liters can in the toilet filled with water for flushing.
- Before use, pour a little quantity of water to wet the pan so that excreta can slide smoothly into the pit.
- Flush the excreta after each use.



- Pour a little quantity of water, say half a liter, in the squatting pan after urination.
- The squatting pan should be cleaned daily with a soft broom or soft brush with a long handle after sprinkling a small quantity of water and detergent powder/soap.
- Use minimum quantity of water in washing the pan and toilet floor.
- Wash hands, using soap or ash, after defecation at the assigned place.
- If any construction defect is observed during the defect-liability period, report the matter to the local authority or the construction agency.
- When the pit in use is full, divert the flow to the second pit
- If the trap gets choked, rodding should be done from the pan side as well as from the rear side by means of a split bamboo stick, after removing the cover of the drain or junction chamber.
- Care should be taken while desludging the pits located in water-logged or high water sub-soil water areas and in case of combined pits, as humus may not be safe for handling.

**Dont's**

- Do not use both the pits at the same time.
- Do not use more than 2 litres of water for each flushing (if the waste is not flushed with 2 litres, pour more water at the specific spots for flushing the waste).
- Do not use caustic soda or acid for cleaning the pan.
- Do not throw sweepings, vegetable or fruit peelings, rags, cotton waste, and cleaning materials like corn cobs, mud balls, stone pieces, leaves, etc. in the pan or the pits.
- Do not allow rain water, kitchen or bath waste to enter the pits.
- Do not provide water tap in the toilet.
- Do not throw lighted cigarette butts in the pan.
- Do not desludge the pit before 1% years of its being in use.

To ensure that the risk of polluting ground water and drinking water sources is minimal, the following safeguards should be taken while locating the pits:

a. Drinking water should be obtained from another source or from the same aquifer but at a point beyond the reach of any fecal pollution from the leach pits.

b. If the soil is fine (effective size 0.2 mm or less), the pits can be located at a minimum distance of 3 m from the drinking water sources, provided the maximum ground water level throughout the year is 2 m or more below the pit bottom (low water table). If the water table is higher, ie. less than 2 m below the pit bottom, the safe distance should be increased to 10 m.

c. If the soil is coarse (effective size more than 0.2 mm), the same safe distances as specified above can be maintained by providing a 500 mm thick sand envelope, of fine sand of 0.2 mm effective size, all around the pit, and sealing the bottom of the pit with an impervious material such as puddle clay, a plastic sheet, lean cement concrete, or cement stabilized soil. If the pits are located under a footpath or a road, or if a water supply main is within a distance of 3 m from the pits, the invert level of the pipes or drains connecting the leach pits should be kept below the level of the water main, or 1 m below the ground level. If this is not possible due to site considerations, the joints of the water main should be encased in concrete.

## Annexure 17- Guidelines for Solid and Liquid Waste Management

Solid and Liquid Waste Management is the main component of sanitation initiatives which rightly emphasizes and focuses on achieving a 'clean village'. SLWM largely promotes the concept of 'Environmental Sanitation' for better health of individual, health and community.

The goal of solid and liquid waste management is to collect, treat and dispose of liquid and solid waste generated by all rural groups in an environmentally and socially satisfactory manner using the most economical means available.

### I SOLID WASTE MANAGEMENT

The solid waste management plants have been classified as Household level, Institutional level and Community level with different capacities under each category. Solid waste should be managed at the household level for effective management of solid waste in rural areas. Composting is one of the best options for treatment of solid waste.

#### 1. COMPOSTING

In composting process the organic matter breaks down under bacterial action resulting in the formation of humus like material called compost. The value of compost as manure depends on the quantity and quality of feed materials poured into the compost pit. Guidelines for Vermi-composting and Ring composting at household level are given below.

##### 1.1 VERMI COMPOSTING

Vermi composting involves the stabilization of organic solid waste through earthworm consumption which converts the material into worm castings. Vermi composting is the result of combined activity of microorganisms and earthworms. Microbial decomposition of biodegradable organic matter occurs through extracellular enzymatic activities (primary decomposition) whereas decomposition in earthworm occurs in elementary tract by micro-organisms inhabiting the gut (secondary decomposition). Microbes such as fungi, actinomycetes, protozoa etc. are reported to inhabit the gut of earthworms. Ingested feed substrates are subjected to grinding in the interior part of the worms gut (gizzard) resulting in particle size reduction.

Vermitechnology, a tripartite system which involves biomass, microbes and earthworms is influenced by the abiotic factors such as temperature, moisture, aeration etc. Microbial ecology changes according to change of abiotic factors in the biomass but decomposition never ceases. Conditions unfavourable to aerobic decomposition result in mortality of earthworms and subsequently no vermi composting occurs

#### HOUSEHOLD LEVEL VERMI COMPOSTING UNITS FOR 1.5 KG/DAY

##### a. Infrastructure & Specifications

- Two numbers of broad mouth plastic basin/ clay pots of 25 litre capacity each
- Base layer with coconut fibre and gravel/sand with cow-dung (~5 kg) powder
- Wire-mesh lid for the basins
- 200 worms in each basin/pot
- Holes at the bottom of the basin to drain leachate/vermi wash to a vessel if kept at below



- Arrangements for protecting the basin from mouse, red ants etc
  - Thick wet cloth or wet sack piece for covering the waste
  - Surgical hand gloves for handling waste & manure
  - Vermi wash collection system is optional
- b. **Standards**
- Eudrillus eugineae worms
  - Moisture content of waste 40-55%
  - Temperature- 20 – 30°C
- c. **Unit cost**
- Rs. 800/- per unit
- d. **O&M Protocols**
- Chop the waste to size less than 5 cm before placing in the basin
  - Thickness of waste layer in the basin should not exceed 15cm
  - Use one basin for the first 15 days and then use the second basin after filling the first
  - Sprinkle cow-dung powder along with waste
  - Protect the basins from mouse, ants and other pests
  - Keep the basin covered with wet sack or cloth piece
  - Sprinkle water over the cover sack/cloth to maintain a moisture of 50-55%
  - Avoid over sprinkling of water and stagnation of liquid at the bottom of the basin
  - Basin should not be exposed to direct sun light or rainfall
  - Prevent introduction of excessive hot, sour and oily substances and also bones, meat & fibre Materials
  - For removing the vermi compost, expose the basin with contents in shaded sunlight for 2-4 hours and remove the compost from the top and use the basin with earthworms for further composting of bio-wastes
  - Compost taken out should not be dried under sunlight
  - Renew the base layer annually
  - Collection of wash out from the basin in the final stages of composting for vermi-wash
- e. **Maintenance cost**
- Rs.0.4 per kg of waste for small house-hold unit
- 1.2. HOUSEHOLD LEVEL ANAEROBIC COMPOSTING UNITS -1.5 KG/DAY WASTE FEED (RING COMPOSTING UNIT)**
- a. **Infrastructure**
- Two sets of circular ferro - cement rings resting on circular ferro - cement slabs and covered by another circular ferro - cement slab with provision for loading the waste from the top and removing the compost from the bottom, when ready.
  - Base layer with cow-dung (~5 kg) powder
  - Surgical hand gloves for handling waste & manure



- b. **Specifications**
- Ferro- cement ring of internal diameter 0.7 m ,thickness 2.5 cm and height 0.5 m placed over a circular ferro-cement slab of dia 0.75m and thickness 2.5 cm (without fixing).
  - The ring to have a 30cmx30cm opening on the side at the bottom with a ferrocement slab cover of the same curved shape which can be removed and refitted back tightly with a locking arrangement for removal of compost when ready.
  - The ring will also have a hole of dia 2.5cm at the bottom for the leachate to flow out.
  - Circular ferro- cement cover slab of 0.75 m diameter and 2.5 cm thick with central circular hole of 0.30 m diameter to cover the ring. The hole will have a lid cover which can be removed and refitted back for loading the waste into the ring and closing it tightly after loading the waste.
- c. **Standards**
- Moisture content of waste 40-55%
  - Temperature- 20 – 30°C
- d. **Unit cost**
- Rs. 1800/- per unit
- e. **O&M Protocols**
- Chop the waste to size less that 5 cm before placing in the basin
  - Remove the top central lid cover of the ring and drop the waste inside the ring
  - Spread the waste evenly in within the ring
  - Use one ring for the first 90 days and then use the second basin after filling the first.
  - After 175 days, compost from the first ring can be emptied from the side opening and the ring can be used for further waste feeding
  - Renew the base layer annually
- f. **Maintenance cost**
- Rs.0.1 per kg of waste for small households

## 2. **BIO GAS PLANT**

When biodegradable organic solid waste is subjected to anaerobic decomposition, a gaseous mixture of Methane (CH<sub>4</sub>) and Carbon-dioxide (CO<sub>2</sub>) known as Biogas could be produced under favourable conditions. The decomposition of the waste materials is mainly done by the fermentation process which is carried out by different group of microorganisms like bacteria, fungus, actinomycetes etc. The group of microorganisms involved for biogas generation is mainly the bacteria.

The process involves a series of reactions by several kinds of anaerobic bacteria feeding on the raw organic matter. "In anaerobic conditions, anaerobic bacteria disintegrate the biodegradable solids by a biochemical process". The biogas technology can be used for management of bio degradable solid waste (portion) generated from:

- Household
- Community
- Commercial establishment

The guidelines for household and community level biogas plant are given below.

#### 2.1 HOUSEHOLD LEVEL (PREFABRICATED -LOW COST TYPE) BIOGAS PLANT

##### a. Infrastructure & Specifications

- Treatment capacity – 2.5 kg of solid waste per day
- Volume of digester including gas holder - 0.50 m<sup>3</sup>
- PVC tank with circular shape as digester and gas holder
- Inlet device with PVC pipe of diameter 110 mm
- Inlet chamber with a plastic mug having circular shape and with a lid.
- Outlet device with PVC pipe of 63mm
- A plastic can of 10 liter capacity to be used for collecting slurry/effluent for safe disposal.
- If toilet waste is also treated in biogas plant, slurry from biogas plant to be treated in a septic tank soak pit arrangement.
- Rubber hose of 25 mm (¾ inch) diameter for conveyance of biogas for use with a maximum length of 10 m
- Stove with single burner
- Control valve for regulating gas

\*Plant to be established in a place fully exposed to sunlight and away from drinking water source.

##### b. Standards

- Minimum waste retention time of 40 days
- All PVC pipe of class 4 kg/cm<sup>2</sup>
- Rubber hose, stove and control valve with ISI mark
- Particle size of waste not to exceed 20 mm

##### c. Unit cost

- Rs.6,500/-

##### d. O&M Protocols

- Start up by adding 50 kg of cow dung with equal quantity of water
- Waste feeding after chopping and mixed with water or part of waste water in the ratio of 1:1
- Daily feeding of easily degradable waste in slurry form or solid waste mixed with equal quantity of water. Rice water, other waste water used for washing of rice, vegetables or meat in the kitchen is used in place of water.
- Limit the maximum quantity of daily feeding of waste to 7.5 kg/ day. A plastic can to be used for collecting slurry/effluent for safe disposal. If toilet waste is also treated in biogas plant, slurry from biogas plant to be treated in a septic tank soak pit arrangement.
- Clean the inlet chamber after each feed and keep it closed
- Prohibited to feed wastes of slow degrading nature like straw, soil, egg shells, fibrous materials like banana leaves, coconut shells, coconut coir, pseudo stem etc. Feeding of toxic substances like fungicides, insecticides, pesticides, detergents, and disinfectant like phenyl, dettol etc. are also prohibited.



- Mix the substrate or rotate the drum at least weekly for preventing scum formation
- e. **Maintenance cost**
  - Rs. 200/- annum per unit

## 2.2. HOUSEHOLD LEVEL FLOATING DOME TYPE BIOGAS PLANT 1M<sup>3</sup> CAPACITY

### a. Infrastructure & Specifications

- Treatment capacity – 7.5 kg of solid waste per day
- Volume of digester(including gas holder) - 1 m<sup>3</sup>
- Digester -PVC tank circular shape
- Gas holder dome PVC/ Fiber Reinforced Plastic (FRP).
- Central support of GI pipe of 40 mm (medium class), fixed to a steel frame work to act as guide for the dome to move up and down
- Inlet device with PVC pipe of diameter 110 mm
- Inlet chamber with plastic container, having circular shape of 30 cm diameter and with a lid.
- Outlet devise with PVC pipe of 63mm diameter.
- A plastic can of 10 liter capacity to be used for collecting slurry/effluent for safe disposal.
- If toilet waste is also treated in biogas plant, slurry from biogas plant to be treated in a septic tank soak pit arrangement.
- Rubber hose of 25 mm (¾ inch) diameter for conveyance of biogas for use with a maximum length of 10 m
- Stove with single burner
- Control valve for regulating gas

\*Plant to be established in a place fully exposed to sunlight and away from drinking water source.

### b. Standards

- Minimum waste retention time of 40 days
- All PVC pipe of class 4 kg/cm<sup>2</sup>
- Medium class GI Pipe for central support
- Rubber hose, stove and control valve with ISI mark
- Particle size of waste not to exceed 20 mm

### c. Unit cost

- Rs.10, 000/- (without septic tank and soak pit)

### d. O&M Protocols

- Start up by adding 50 kg of cow dung with equal quantity of water
- Waste feeding after chopping and mixed with water or part of waste water in the ratio of 1:1
- Daily feeding of easily degradable waste in slurry form or solid waste mixed with equal quantity of water. Rice water, other waste water used for washing of rice, vegetables or meat in the kitchen is used in place of water.
- Limit the maximum quantity of daily feeding of waste to 7.5 kg/ day. A plastic can to be used for collecting slurry/effluent for safe disposal. If toilet waste is

also treated in biogas plant, slurry from biogas plant to be treated in a septic tank soak pit arrangement.

- Clean the inlet chamber after each feed and keep it closed
- Prohibited to feed wastes of slow degrading nature like straw, soil, egg shells, fibrous materials like banana leaves, coconut shells, coconut coir, pseudo stem etc.,
- Feeding of toxic substances like fungicides, insecticides, pesticides, detergents, and disinfectant like phenyl, dettol etc. are also prohibited.
- Mix the substrate or rotate the drum at least weekly for preventing scum formation

e. **Maintenance cost**

- Rs. 500/- annum per unit

2.3 **COMMUNITY LEVEL BIOGAS PLANT (FLOATING DOME TYPE) (CAPACITY 300 KG TO 2000KG OF SOLID WASTE PER DAY)**

a. **Infrastructure**

- Pre-processing room with space to accommodate the pulverizing /grinder mixer machine and an inlet mixing chamber for mixing the pulverized waste, provision of a platform outside the room with extended roof and ramp, to receive the waste digester.
- Inlet mixing cum feeding tank near to the digester, with locking arrangements for feeding waste to the digester
- Inlet devices with PVC pipe of diameter 150 mm, connecting the bottom of the inlet mixing chamber located inside the pre-processing room for conveyance of pulverized waste to the inlet feeding tank and connecting the inlet feeding tank and the digester.
- Digester with reinforced cement concrete and brick masonry lining on both sides and having the following;
- Bottom slope of digester shall be 1 in 8 for easy withdrawal of sludge.
  - Outlet devise with PVC pipes 140 to 200mm
  - Floating Gas holder dome with fibre reinforced plastic (FRP)
  - Central support of GI pipe medium grade 65 to 100 mm fixed to base concrete/ fixed to central beam of the dome.
- Pumps of screw type or submersible type or external chemical process type for pumping water, slurry and sludge.
- Pre-digester tank for increasing the efficiency of main digester/digesting of slow digesting items for plants of capacity 1 Ton and above.
- A Pulverizing machine /grinder mixer for reducing the size of waste larger than 20mm and to mix the same with water and putting it into inlet mixing tank inside the preprocessing room. Waste to be converted into slurry form by mixing it with equal volume of water to feed in to the digester for easy and clog free digestion.
- Pre-filter tank with four number of chambers in series with baffle walls in between. The slurry from the outlet manhole passes through the baffle walls and flow to the septic tank. Certain amount of slurry get settle down in the pre-filter which is to be cleared periodically. This is to reduce the load on the septic tank.



- Septic tank - soak pit system for treatment and disposal of effluent from biogas plants.
  - Rubber hose for conveying gas 20 mm dia ,min 40 meters long,, moisture trap, H<sub>2</sub>S scrubber, pressure blower ,fire arrestor, regulator and a gas stove to spend the gas.
  - Control Panel for monitoring / operation
- b. Notes
- All metal parts to be coated with epoxy primer and epoxy enamel for avoiding corrosion.
  - All masonry tanks to be coated with epoxy or other corrosion resistant coating.
  - Plant to be established in a place fully exposed to sunlight and away from drinking water source.
  - Gas utilisation for heating /cooking purpose.
- c. Optional items (to be ordered separately)
- A balloon storage facility for storage of at least ¾th of bio gas generated in a day.1/4<sup>th</sup> quantity of the gas produced in a day is stored inside the floating gas holder chamber of the digester itself.
  - Water heater working on bio-gas is mounted on the wall of the pre-processing room, with all safety arrangements and plumbing .Hot water be utilized to mix with the feed waste.
  - Gas measuring meter for supplying the gas to the nearest domestic/commercial customer/s.
  - Solar water heater for making hot water to mix with the water to maintain the temperature where considered necessary in plants of 1000 to 2000 kg
  - Bio gas engines of single mode fuel (using methane gas only) in special cases only after obtaining approval from Suchitwa Mission Additional facilities include;
  - Facility for utilizing the electricity generated for operating equipments in the plant / lighting the plant area.
  - Facility for flaring of excess gas with automatic or semi automatic flame ignition.
  - Facility for Biogas cleaning for removal of water vapour and H<sub>2</sub>S concentration to 100 ppm or less
- d. Standards
- Minimum 45 days waste retention time
  - Particle size of waste not to exceed 20 mm
  - Rubber hose of ¾ to 1 1/2 inch diameter with maximum length of 40 m for conveyance of biogas
  - All PVC pipe of class 4 kg/cm<sup>2</sup>
  - Rubber hose, stove and control valve with ISI mark
  - The capacity of the bio gas plant to be mentioned in terms of the loading rate (ie, maximum quantity of waste to be fed in kg per day).
- e. Land requirement
- Land area 20mx10m for 300 kg plant to 30mx15m for 2000 kg plant

**f. Unit cost**

- Total cost of setting up of a bio-gas plant capacity wise is given under (in Rs lakhs)

300 Kg/day	400 Kg/day	500 Kg/day	600 Kg/day	800 Kg/day	1000 Kg/day	1500 Kg/day	2000 Kg/day
4.97	5.52	5.91	6.29	6.80	7.94	9.88	11.30

**Note**

- Estimating has been done based on Kerala PWD schedule rates 2010.
- Estimate is based " all soil conditions "(mix of ordinary soil and hard soil in the ratio 50:50) and to be suitably modified for different site conditions
- Optional items are not included in the cost.
- The cost include contractors' profit ,but doesn't include statutory works tax or service tax

**g. O&M Protocols**

- Start up by adding cow dung and equal quantity of water
- Waste feeding after chopping and mixed with water in the ratio 1:1
- Daily feeding of easily degradable waste in slurry form or waste mixed solid with equal quantity of water
- Limit the quantity of daily waste feed below the designed capacity
- Maximum particle size of waste shall be 20 mm
- Daily removal of slurry in to Septic Tank - Soak Pit system
- Clean the inlet chamber after each feeding and keep it closed
- Prohibited to feed wastes of slow degrading nature like straw, soil, egg shells, fibrous materials like banana leaves, coconut shells, coconut coir, pseudo stem etc. Feeding of toxic substances like fungicides, insecticides, pesticides, detergents, and disinfectants like phenyl, dettol etc. are prohibited.
- Mix the substrate or rotate the drum at least weekly for preventing scum formation
- Skilled Manpower for Operation of the Plant.
- Operation and maintenance contract with the executing agency/ supplier for a period of 2 years after installation and initial capacity building period of six months of plant

**h. Maintenance cost**

- Consultancy charges in Rs for technical support and capacity building for the initial period of six months are as under:-

Upto 500 Kg plant	600-900 Kg plant	1000 Kg & above
30,000	40,000	50,000

- Operation and maintenance cost per annum in Rs lakh capacity wise are given as under:-

300 Kg	400 Kg	500 Kg	600 Kg	800 Kg	1000 Kg	1500 kg	2000 Kg
0.6	0.7	0.8	1.0	1.15	1.35	1.6	1.85



The gas generated be utilised or sold to nearby customers by the local body.

#### 2.4 COMMUNITY LEVEL (FIXED DOME TYPE) BIOGAS PLANT CAPACITY 300 TO 2000 KG/DAY

##### a. Infrastructure

- Pre-processing room with space to accommodate the pulverizing machine and an inlet mixing chamber to mix the pulverized waste. A platform outside with extended roof to receive the waste.
- Inlet mixing cum feeding tank constructed near to the digester, with locking arrangements for feeding the waste to the digester.
- Inlet devices with PVC pipe of diameter 150 mm one from the inlet mixing chamber for the pulverized waste located inside the pre-processing room to the common inlet mixing cum feeding tank located outside near the digester and another inlet pipe from this outside feeding tank to the digester.
- Digester with reinforced cement concrete with brick masonry lining on both sides and having the following;
  - Bottom slope of digester shall be 1 in 8 for easy withdrawal of sludge.
  - Outlet opening with 200 to 300 mm diameter.
  - Outlet (balancing) tank with cement concrete/brick masonry lining on both sides having a free board of 30 cm.
- Pumps of screw type or submersible type or external chemical process type for pumping water, slurry and sludge.
- Pre-digester tank for increasing the efficiency of main digester/digesting of slow digesting items in plants of capacity 1 ton and above
- A Pulverizing machine /Shredder for reducing the size of items of bigger size into uniform size and mixing the same with water inside the mixing tank (No1) provided in the pre-processing room..
- Pre-filter tank with four number of chambers in series with baffle walls in between to reduce the load on the septic tank.
- Septic Tank - soak pit system for treatment and disposal of effluent from biogas plants.
- Rubber hose for conveying gas 20 mm dia min 40 meters long, moisture trap, H<sub>2</sub>S scrubber, pressure blower, fire arrestor, regulator and a gas stove to spend the gas.
- Control panel for monitoring / operation

##### Notes:-

- All metal parts to be coated with epoxy primer and epoxy enamel for avoiding corrosion.
- All masonry tanks to be coated with epoxy or other corrosion resistant coating.
- Plant to be established in a place fully exposed to sunlight and away from drinking water source.
- Gas utilisation for heating /cooking purpose

- b. **Optional items (to be ordered separately)**
- A balloon storage facility for storage of at least  $\frac{3}{4}$ <sup>th</sup> of bio gas generated in a day.  $\frac{1}{4}$ <sup>th</sup> quantity of the gas produced in a day is stored inside the gas holder chamber of the digester itself.
  - Provide a water heater working on bio-gas with necessary safety arrangements and be mounted on the wall of the pre-processing room to heat the water before mixing with the waste input, along with necessary plumbing.
  - Provision of gas measuring meter to supply gas to the nearest household/commercial establishments on cost.
  - Solar water heater for making hot water to mix with the water to maintain the temperature where considered necessary in plants of 1000 kg/day capacity and above.
  - Bio gas engines of single mode fuel (using methane gas only) in special cases only after obtaining approval from Suchitwa Mission. Additional facilities include;
    - a. Facility for utilizing the electricity generated for operating equipments in the plant / lighting the plant area.
    - b. Facility for flaring of excess gas with automatic or semi automatic flame ignition.
    - c. Facility for Biogas cleaning for removal of water vapour and H<sub>2</sub>S concentration to 100 ppm or less.
- c. **Standards**
- Minimum 45 days waste retention time
  - Particle size of waste not to exceed 20 mm
  - Rubber hose of  $\frac{3}{4}$  to 1  $\frac{1}{2}$  inch diameter with maximum length of 40 m for conveyance of biogas
  - All PVC pipe of class 4 kg/cm<sup>2</sup>
  - Rubber hose, stove and control valve with ISI mark
  - The capacity of the bio gas plant to be mentioned in terms of the loading rate (ie, maximum quantity of waste to be fed in kg per day)
- d. **Land requirement**
- 5 to 10% more land area than the floating drum type plant
- e. **Unit cost**
- Total costs of setting up of a bio-gas plant are given capacity wise as under (Rs lakh):-

300 Kg/day	400 Kg/day	500 kg/day	600 Kg/day	800 Kg/day	1000 Kg/day	1500 Kg/day	2000 Kg/day
5.9	6.8	7.42	8.17	9.10	10.3	13.0	15.9

- Estimating has been done based on Kerala State PWD schedule of rates 2010.
- Estimate is based all "soil conditions "(50% ordinary soil and 50% hard soil) and to be suitably modified for different site conditions. Any changes in the design to be ratified by the competent authority.
- Optional items are not included in the cost.





- The estimate includes contractors' profit of 10% but doesn't include statutory works tax or service tax.

f. **O&M Protocols**

- Start up by adding cow dung and equal quantity of water
- Waste feeding after chopping and mixed with water in the ratio 1:1
- Daily feeding of easily degradable waste in slurry form or solid waste mixed with equal quantity of water
- Limit the quantity of daily waste feed below the designed capacity
- Maximum particle size of waste shall be 20 mm
- Daily removal of slurry in to Septic Tank - Soak Pit system
- Clean the inlet chamber after each feeding and keep it Closed.
- Prohibited to feed wastes of slow degrading nature like straw, soil, egg shells, fibrous materials like banana leaves, coconut shells, coconut coir, pseudo stem etc. These be put into pre-digester for pre-digestion
- Feeding of toxic substances like fungicides, insecticides, pesticides, detergents, and disinfectants like phenyl etc. are prohibited.
- Mix the substrate or rotate the drum at least weekly for preventing scum formation.
- Skilled Manpower for Operation of the Plant.
- AMC with the executing agency/ supplier for a period of 2 years after installation and initial capacity building period of six months of plant

g. **Maintenance cost**

- Consultancy charges for technical support and capacity building for the initial six months given below in Rs lakh , capacity wise

Upto 500 Kg plants	600 - 900 Kg plants	1000 Kg and above
0.30	0.40	0.50

- Operation and maintenance cost per annum in Rs. lakh, after the initial six months period ,plant wise given as:-

300 Kg	400 Kg	500 Kg	600 Kg	800 Kg	1000 Kg	1500 Kg	2000 Kg
0.6	0.8	1.0	1.2	1.4	1.5	1.7	1.85

The gas generated will be utilized /sold to nearby customers by the local body.

**II LIQUID WASTE MANAGEMENT**

Various technological options for waste water management are available which suit in both urban and rural settings. Sewage treatment and disposal plant is an expensive option and not affordable by low income communities and by small communities in rural areas. This resulted in the development of several alternative low cost disposal methods, with almost the same health benefits. Among those, septic tanks are widely used and are discussed in detail below.



**SEPTIC TANK**

A septic tank is a combined sedimentation and digestion tank where the sewage is held for one or two days. During this period, the suspended solids settle down to the bottom. This is accompanied by anaerobic digestion of settled solids (sludge) and liquid, resulting in reasonable reduction in the volume of sludge, reduction in biodegradable organic matter and release of gases like carbon-di-oxide, methane and hydrogen sulphide. Therefore the septic tank effluent disposal merits careful consideration. For larger communities, septic tanks may be adopted with appropriate effluent treatment and disposal facilities.

**Design**

Septic tank should be designed so that the accumulated sludge and scum and occupy only half or maximum two-thirds the tank capacity at the end of the design storage period. The minimum liquid retention time should be 24 hours for effective sedimentation of the suspended solids. Therefore considering the volume required for sludge and scum accumulation, the septic tank may be designed for 1 to 2 days of wastewater retention.

The septic tanks are normally rectangular in shape and can either be a single tank or a double tank. In case of double tank, the effluent solids concentration is considerably lower and the first compartment is usually twice the size of the second. The liquid depth is 1-2 m and the length to breadth ratio is 2-3 to 1. Recommended sizes of septic tanks for individual households (upto 20 users) and for housing colonies (upto 300 users) are given in Table below.

**Recommended sizes of septic tank (up to 20 users)**

No of users	Length (m)	Breadth (m)	Liquid Depth (cleaning interval of)	
			2 years	3 years
5	1.5	0.75	1.0	1.05
10	2.0	0.90	1.0	1.40
15	2.0	0.90	1.3	2.00
20	2.3	1.10	1.3	1.80

Note 1: The capacities are recommended on the assumptions that discharge from only WC will be treated in the septic tank.

Note 2: A provision of 300 mm should be made for free board.

Note 3: The sizes of septic tank are based on certain assumptions on peak discharges, as estimated in IS: 2470 (Part - 1)1985 and while choosing the size of septic tank exact calculations shall be made.

**Recommended size of septic tank for residential colonies**

No of users	Length (m)	Breadth (m)	Liquid Depth (cleaning interval of)	
			2 years	3 years
50	5.0	2.00	1.0	1.24
100	7.5	2.65	1.0	1.24
150	10.0	3.00	1.0	1.24



200	12.0	3.30	1.0	1.24
300	15.0	4.00	1.0	1.24

Note 1: A provision of 300 mm should be made for free board

Note 2: The sizes of septic tank are based on certain assumptions on peak discharges, as estimated in IS: 2470 (Part - 1)1985 and while choosing the size of septic tank exact calculations shall be made.

Note 3: For population over 100, the tank may be divided into independent parallel chambers of maintenance and cleaning.

#### Construction Details

To avoid short circuiting, the inlet and outlet should be located as far away as possible from each other and at different levels. Baffles are generally provided at both inlet and outlet and should dip 25 – 30 cm into and project 15 cm above the liquid. The baffles should be placed at a distance of one fifth of the tank length from the mouth of the straight inlet pipe. The invert of the outlet pipe should be placed at a level 5 to 7 cm below the invert level of inlet pipe. Baffled inlet will distribute the flow more evenly along the width of the tank and similarly a baffled outlet pipe will serve better than a tee - pipe.

For larger capacities, a two compartment tank constructed with the partition wall at a distance of about two-thirds the length from the inlet gives a better performance than a single compartment tank. The two compartments should be inter - connected about the sludge storage level by means of pipes or square openings of dia or side length respectively of not less than 75 mm.

Every septic tank should be provided with ventilation pipes, the top being covered with a suitable mosquito proof wire mesh. The height of the pipe should extend at least 2 m above the top of the highest building within a radius of 20 cm.

Septic tanks may either be constructed in brick work, stone masonry or concrete cast in situ or pre-cast materials. All septic tanks shall be provided with water tight covers of adequate strength. Access manholes of adequate size shall also be provided for purposes of inspection.

The floor of the tank should be of cement concrete and sloped towards the sludge outlet. Both the floor and side wall shall be plastered with cement mortar to render the surface smooth and to make them water tight.

#### Sludge Withdrawal

Desludging of septic tanks under hydrostatic head by means of a sludge pipe-collection of sludge from the lowest point in the tank and discharging at a higher level should be encouraged. As far as possible, manual handling of sludge should be avoided. Mechanical vacuum tankers should be used to empty the tanks.

#### Secondary treatment and Disposal of effluent

The septic tank effluent will be malodorous, containing sizeable portion of dissolved organic content and pathogenic organisms and hence need to be treated before its final , safe disposal. Soak pits or dispersion trenches can be adopted in all porous soils where soak percolation rate is below 25 minutes/cm and the depth of the

water table is 2 m or more from the ground level. Dispersion trenches should be preferred in soils with percolation rate is between 12 and 25 minutes if adequate land is available. In areas with higher water table dispersion trenches should be located partly or fully above ground level.

The sub soil dispersion system shall be atleast 20 m away from any source of drinking water. It should be as far as possible from the nearest dwellings but not close than 7 m to avoid any corrosive effect due to tank gases vented into the atmosphere. This system is not recommended in limestone or crevice rock formations where they may be solution cavities which may convey the pollution to long distances and pollute water resources.

The total sub surface soil area required for soak pits or dispersion trenches is given by the empirical relation:

$$Q = 130 (t)^{1/2}$$

Where,

Q = maximum rate of effluent application in lpd/m<sup>2</sup> of leaching surface and

t = Standard Percolation rate for the soil in minutes.

In calculating the effective leaching area required, only area of trench bottom in case of dispersion trenches and effective side wall area below the inlet level for soak pits should taken into account.

#### Soak Pits

Soak pits or seepage pits are cheap to construct and are extensively used. They need no media when lined or filled with rubble or brick bats. The pits may be of any rectangular shape, circular or square being common. When water table is sufficiently below ground level, soak pits should be preferred only when land is limited or when a porous layer underlies an impervious layer at the top, which permits easier vertical downward flow than horizontal spread out as in the case of dispersion trenches. Minimum horizontal dimension of soak pit should be 1 m, the depth below the invert level or inlet pipe being at 1 m. The pit should be covered and the top raised above the adjacent ground to prevent damage by flooding.

#### Dispersion Trenches

Dispersion trenches consist of relatively narrow and shallow trenches about 0.5 to 1 m deep and 0.3 to 1 m wide excavated to a slight gradient of about 0.25 %. Open joined earthenware or concrete pipes of 80 to 100 mm size are laid in the trenches over a bed of 15 to 25 cm of washed gravel or crushed stone. The top of pipes shall be covered by coarse gravel and crushed stone to a minimum depth of 15 cm and the balance of depth of trench filled with excavated earth and finished with a mound above ground level to prevent direct flooding of trench during rains. The effluent from the septic tank is led to into a small distribution box from which several such trenches could radiate out. The total length of trench required shall be calculated from the above formula and the number of trenches worked out on the basis of a maximum length of 30 m for each trench and space not closer than 2 m apart. Parallel distribution should be such that a distribution box should be provided for 3 to 4 trenches.

Annexure 18 -Formats for Environmental Data Sheets (EDS)

A. EDS for Water Supply

S.No	Description	Particulars		Remarks
<b>GENERAL</b>				
1	Name of habitation			
2	Name of Gram Panchayat			
3	Name of block			
4	Name of district			
5	Population			
6	Total water demand (LPD)			
7	present water supply (LPD)			
8	Present classification of habitation	NC/NSS/PC		
9	Problem with present water supply			
10	Net demand of water from the proposed source (lpd)			
11	Type of source	Ground water	Surface water	
12	Type of scheme	SWSS	Multi GP/ LWSS	
13	Is de-fluoridation planned?	Yes	No	
<b>LOCATION</b>				
14	Where is the source located			
15	Has a sanitary survey of the source location been done? (Enclose the report of sanitary survey)			Refer Sanitary Survey Guidelines in Annexure 8.
16	Is any component of the scheme located in a forest area?	Yes	No	If yes, obtain permission from Forest Dept.
17	Is the source in near (within 5 km) any ecologically sensitive area (national parks, wildlife sanctuary)?	Yes	No	Avoid sensitive areas. If not possible, obtain permission from forest Dept and follow mitigation measures suggested by forest dept.

18	Are any trees likely to be cut at the location for construction of the scheme? If yes, mention the number of trees			
<b>IN CASE OF GROUNDWATER SOURCE</b>				
<b>AQUIFER STATUS AND SUSTAINABILITY</b>				
19	What is the type of aquifer?	Shallow aquifer	Deep aquifer	
20	Total depth of well (metres)			
21	Depth to groundwater table below GL (m)			
22	Summer			
23	Winter			
24	Is the groundwater tapping in safe zone (classified based on exploitation)?	Yes	No	
25	What are the measures proposed for source sustainability?	GWR structure	Limiting the draft to safe yield	
<b>LOCATION OF THE WELL</b>				
26	What is the distance of this source from the nearest leach pit of any existing sanitation facility? (It should be more than 15 metres)			
27	What is the distance of this source from the nearest rain water harvesting pit? (It should be more than 15 metres)			
28	What is the distance of the source from the nearest existing well? (It should be more than 300 metres)			
<b>STRUCTURE OF THE WELL</b>				
29	Will the well be provided with sanitary plug till the pump is installed?	Yes	No	
30	Is a concrete mat (of at least 75 cm radius) planned around the bore well?	Yes	No	
31	Is grouting of the space outside the well casing planned?	Yes	No	

<b>WATER QUALITY</b>				
32	Is the quality of water acceptable? (water quality test report is mandatory)	Yes	No	
33	If not acceptable, mention the type of water quality problem			
34	What is the alternative proposed?			
35	If the water is to be treated, mention the treatment process			
36	What is the frequency planned for testing water for bacteriological contamination? (should be 1 initially and later as required)			
37	What is the frequency planned for testing water for physical and chemical contamination? (should be 4 times/year)			
38	What is the frequency planned for testing residual chlorine? (should be at least once a week)			
39	What is the frequency planned for sanitary inspection by GPE? (should be 4 times/year)			
40	What is the frequency planned for sanitary inspection by SE? (should be once in year)			
<b>IN CASE OF SURFACE WATER SOURCE</b>				
<b>LOCATION</b>				
41	Will there be any significant land disturbance resulting in erosion, subsidence and instability?	Yes	No	
42	Will the scheme involve alteration of natural drainage? If yes, indicate the measure for the drainage	Yes	No	
<b>SUSTAINABILITY</b>				
43	Is the expected safe yield from the source greater than water demand?	Yes	No	
<b>WATER QUALITY</b>				
44	What is the turbidity of raw water (NTU)? (enclosed water quality test report)			

45	Is this source within 100 m from the nearest sewage /industrial effluent disposal point (disposal into the surface water source)?	Yes	No	
46	Is there any chemical impurity present? If yes, furnish the details.(enclose water quality test report)	Yes	No	
47	What is the frequency planned for testing water for bacteriological contamination? (should be every month)			
48	What is the frequency planned for testing water for physical and chemical contamination? (should be 4 times/year)			
49	What is the frequency planned for testing residual chlorine? (should be once every day)			
50	What is the frequency planned for sanitary inspection by GPE? (should be 12 times/year)			
51	What is the frequency planned for sanitary inspection by SE? (should be 2 times / year if population serviced is less than 5000; should be 24-48 times/ year if population services is between 5000-20000)			
<b>WATER TREATMENT</b>				
52	What is the method of water treatment proposed?			
53	How will the sludge and other residue from the water treatment plant be disposed?			

Mitigation measures<sup>2</sup> for addressing the issues concerned with quality and quantity of water sources.

- 1.
- 2.
- 3.
- 4.
- 5.
- 6.

<sup>2</sup> Refer Environmental Code of Practices (Table 4-2) for addressing the mitigation measures



- 7.
- 8.
- 9.
- 10.

Prepared by  
Signature  
Designation  
(GPE of RPMU)

Endorsed by  
Signature  
Designation  
SE of RPMU

SWSS – Single Water Supply Scheme    LWSS – Large Water Supply Scheme

**B.    EDS for Rain Water Harvesting**

S.No	Description	Particulars		Remarks
<b>GENERAL</b>				
1	Name of Habitation			
2	Name of Gram Panchayat			
3	Name of Block			
4	Name of District			
5	Population (present)			
6	Total water demand (Litres per day)			
7	Present water supply (Litres per day)			
8	Problem with present water supply	Source is inadequate in summer	Water table is depleted in summer	
<b>LOCATION</b>				
9	What is the distance of the RWH Structure from the nearest bore well? (should be 15 m away)			
10	Is the RWH located away from any supply / feeder channel of tanks?			

	(RWH must not be in these locations)			
11	Has the location of RWH structure been certified by a hydro geologist of the KRWSA?			
12	Is there any possibility of contaminated water flowing into the RWH structure?			
13	Any special features in hilly / plain terrain?			
<b>STRUCTURE</b>				
13	Type of RWH structure			
14	Intended use of rain water			
<b>HOUSEHOLD ROOFTOP RWH STRUCTURE</b>				
15	Is the roof smooth, free from any toxic materials (including paint)?			
16	Are there any overhanging trees nearby?			
<b>S.No</b>	<b>Description</b>	<b>Particulars</b>		<b>Remarks</b>
17	Is there provision planned for discarding first flush of rain water?			
18	Is there provision planned for wire mesh screens at gutter heads?			
19	Is there provision for safe extraction of the harvested rain water? (filtration, disinfection, gravity tap)			
<b>MAINTENANCE</b>				
20	What is the planned frequency of conducting complete maintenance check and cleaning of the RWH system? (recommended before and after every rain; cleaning after every dry period of 1 month)			
21	What is the planned frequency of conducting complete maintenance check and cleaning of the RWH system? (recommended before and after every rain; cleaning after every dry period of 1 month)			

Mitigation measures<sup>3</sup> (if any)

1.

<sup>3</sup> Refer Environmental Code of Practices (Table 4-2) for addressing the mitigation measures



- 2.
- 3.
- 4.
- 5.
- 6.
- 7.
- 8.

Prepared by:  
Signature :  
Designation:  
(GPE of RPMU)

Endorsed by:  
Signature :  
Designation:  
(SE of RPMU)

RWH – Rain water Harvesting

C. EDS for Sanitation Schemes

S.No	Description	Particulars		Remarks
<b>GENERAL</b>				
1	Name of Habitation			
2	Name of Gram Panchayat			
3	Name of Block			
4	Name of District			
5	Population (present)			
6	No. of ISL proposed			
<b>LOCATION</b>				
7	Are any trees likely to be cut at the location for construction of the scheme? If yes, mention the number of trees.			If yes, permission has to be obtained from Forest Dept.
8	Type of substrata	Pervious	Impervious	



9	Depth to groundwater table			
10	*winter			
11	*summer			
12	Is a shallow aquifer used as source for drinking water supply in the habitation?			
13	Is the habitation located in coastal area?			
14	Is a minimum distance of 15 metres maintained between the pits and the nearest drinking water sources? (for all the ISLs proposed)	Yes	No	
15	In case of high ground water table and in case of highly permeable soils, is a minimum distance of 40 metres maintained between the pits and the nearest drinking water sources? (for all the ISLs proposed)	Yes	No	Not applicable
<b>STRUCTURE</b>				
16	What is the type of toilet proposed?			
17	For ISL			
18	What are the precautions taken to prevent groundwater contamination?			
<b>S.No</b>	<b>Description</b>	<b>Particulars</b>		<b>Remarks</b>
19	In case of high ground water table, is raising of platform, bottom sealing of pit and earth filling outside along sides of pit planned?			Not applicable
20	In case of flood prone area, is raising of platform and earth filling outside along sides of pit planned?			Not applicable
21	In case of loose soils, is lining of pits with perforated cement rings planned?			Not applicable
22	In case of soils with low permeability, is back filling of part of pit with more sandy soil planned?			Not applicable
23	In case of soils with high permeability, is earth filling around rings with denser soil planned?			Not applicable
<b>MAINTENANCE</b>				
24	Is an awareness programme for prospective users on proper use and maintenance of the IHLs being planned?			



25	Is adequate water available for use? (2 litres per each use)			
26	What is the expected cleaning interval of pits? (a pit should not be emptied before 1 1/2 years after its being in use)			
27	What is the method of disposal of materials removed from pits?			

Mitigation measures<sup>4</sup> (if any)

- 1.
- 2.
- 3.
- 4.
- 5.
- 6.
- 7.
- 8.

Prepared by  
Signature  
Designation:  
(GPE of RPMU)

Endorsed by  
Signature  
Designation  
(SE of RPMU)

ISL - Individual Sanitary Latrine

<sup>4</sup> Refer Environmental Code of Practices (Table 4-2) for addressing the mitigation measures



D. EDS for Household Soak Pits

S. No	Description	Particulars		Remarks
<b>General</b>				
1	Name of Habitation			
2	Name of Gram Panchayat			
3	Name of Block			
4	Name of District			
5	Population (present)			
<b>Location</b>				
6	Is the soak pit located in rocky terrain? (Not suitable)	Yes	No	
<b>Structure</b>				
7	Will the wastewater flow exceed the design flow of the soak pit? (calculate design flow as per requirement for bathing 20-30 lpcd, kitchen 5-10 lpcd, washing clothes 15-20 lpcd, and other uses)	Yes	No	
8	Is filling material of appropriate size available? (Should be pebbles of sizes 125 - 150, 100 -125 and 50- 75 mm)	Yes	No	
9	Is the pit to be filled loosely? (Filling material must not be tightly packed)	Yes	No	
10	Is the pit to be filled with murrum, brickbats or sand? (These materials must not be used)	Yes	No	
<b>Maintenance</b>				
11	What is the frequency planned for cleaning the filter of the soak pit? Must be cleaned every fortnight or month			
12	What is frequency planned for cleaning the pit and replacing the filling material? Must be once in 7 - 8 yrs ?			

Mitigation Measures<sup>5</sup> (if any)

1.

<sup>5</sup> Refer Environmental Code of Practices (Table 4-2) for addressing the mitigation measures

- 2.
- 3.
- 4.
- 5.
- 6.
- 7.
- 8.

Prepared by  
Signature  
Designation  
(GPE of RPMU)

Endorsed by  
Signature  
Designation  
(SE of RPMU)

E. EDS for Community Solid Waste Management

S.No	Description	Particulars		Legal Requirements
<b>GENERAL</b>				
1	Name of Habitation			
2	Name of Gram Panchayat			
3	Name of Block			
4	Name of District			
5	Population (Present)			
<b>LOCATION</b>				
6	Type of substrata	Pervious	Impervious	
7	Depth to groundwater table in metres			
8	winter			
9	Summer			
<b>WASTE GENERATION</b>				
10	What is the expected quantity of solid waste generation			

	per day? (tons)			
11	What is the expected quantity of bio degradable waste (waste that can be composted) per day? (tons)			
12	What is the expected quantity of non bio degradable waste (waste that can be composted) per day? (tons)			
<b>WASTE MANAGEMENT</b>				
<b>WASTE SEGREGATION AND COLLECTION</b>				
13	Are awareness programmes on household waste segregation planned to be organized?	Yes	No	
14	Is segregation of wastes at household level (into biodegradable and non-biodegradable wastes) being planned?	Yes	No	
15	How will the household waste be collected?	Community waste bins	Door to door collection	
16	Are the community waste bins planned to be located at least 15 m away from any water sources?			
17	What is the planned frequency of collecting waste (from community bins or from individual households)?			
<b>COMPOSTING FOR BIODEGRADABLE WASTE</b>				
18	What is the type of composting planned? Underground (lined or unlined) pits -suitable for low rainfall areas Over ground heap or tank -suitable for high rainfall areas and rocky terrain Vermi compost units			
<b>FOR COMPOSTING UNITS</b>				
19	Will the wind flow direction at the composting yard cause foul odor in the habitation?			
20	Is the compost yard in a low lying area (likely to get water logged)?			
21	Will weekly covering of the compost pit/heap with thin			



	soil layer planned to avoid odour and fly nuisance?			
<b>FOR VERMI-COMPOSTING UNITS</b>				
22	What is the variety of earthworms planned? (local or exotic) (local variety -Lumpito mnzrritii is preferred to exotic varieties -Eiseniujbetida and Eudrilus euginiae)			
23	Is the vermi-composting unit located in an area that is not low-lying and has adequate slope (to prevent water-logging)?			
24	What pest control (control of red ants, cockroaches, etc.) methods are planned at the vermi-composting unit? (Only non-chemical methods such as application of turmeric and flour around perimeter of the tank must be practiced)			
<b>MANAGEMENT OF NON-BIODEGRADABLE WASTE</b>				
25	What part of the non-biodegradable waste will be recycled?			
26	What part of the non-biodegradable waste will be sent to the land fill?			
27	Is the site identified for the land fill located in a forest area?	Yes	No	Avoid forest area.
28	Is the site located for the land fill near (within 5 km) any ecologically sensitive area (National Parks, Wildlife Sanctuaries)?	Yes	No	Avoid having the landfill near the sensitive area.
29	What is the extent of land available for the land fill site?			Obtain clearance from Kerala PCB.
30	What is the ownership of the land identified for the land fill site?	Government/ Panchayat land	Private land	If private land, follow recommended guidelines for acquisition.

31	What is the distance of the land fill site from nearest water supply source/catchment boundary/water body (less than 100 m?)			
32	What are the precautions taken / planned to prevent surface and groundwater contamination?			
33	Is periodic covering of waste with minimum 10 cm of soil / debris planned?			
34	Is covering of waste with 40-65 cm thick soil cover planned before every monsoon (to prevent infiltration)?			
35	Is an appropriate drainage system planned at the land fill site to divert run off water?			
36	Will the land fill site have fencing and a gate to prevent entry of stray animals and unauthorized persons?			
37	Has baseline data on groundwater quality in the area been collected (for future reference)? Enclose report water quality test.			
38	Is periodic and regular monitoring of ground water quality in the area planned?			

Mitigation Measures<sup>6</sup> (if any)

- 1.
- 2.
- 3.
- 4.

<sup>6</sup> Refer Environmental Code of Practices (Table 4-2) for addressing the mitigation measures



Environmental Assessment and Environmental  
Management Framework for Jalanidhi-2

---

- 5.
- 6.
- 7.
- 8.
- 9.
- 10.

Prepared by  
Signature  
Designation  
(GPE of RPMU)

Endorsed by  
Signature  
Designation  
(SE of RPMU)



**Annexure 19- Categorization of Schemes**

<b>Category I (Low Impact)</b>	<b>Category II (Medium Impact)</b>	<b>Category III (High Impact)</b>
<b>1) Water Supply Schemes</b>		
<ul style="list-style-type: none"> <li>a. SWSS involving pumping, construction of storage tanks and piped distribution networks, with source as open well/ bore well.</li> <li>b. SWSS with source as spring where water will flow by gravity to the distribution network.</li> <li>c. Existing WSS requiring rehabilitation.</li> <li>d. Roof water harvesting units, where scattered households cannot be served by piped network.</li> <li>e. Ground water recharge measures.</li> </ul>	<ul style="list-style-type: none"> <li>a. SWSS with water source requiring special treatment for removal of iron, fluoride, and salinity</li> </ul>	<ul style="list-style-type: none"> <li>a. LWSS with source as river where water will have to be conveyed from long distances.</li> <li>b. SWSS with source located in /very close to natural habitat/ sensitive ecosystems such as National parks, Wild life sanctuaries (requiring forest permission/clearance)</li> </ul>
<b>2) Environmental Sanitation</b>		
<ul style="list-style-type: none"> <li>a. Construction of ISL where subsurface strata is favorable for adopting twin pit pour flush toilets and groundwater table is at depth greater than 3.0 m below ground level.</li> </ul>	<ul style="list-style-type: none"> <li>a. Community latrines and disposal of sewage through septic tanks / soak pits where ground water table is less than 3m.below ground level</li> </ul>	<ul style="list-style-type: none"> <li>a. Construction of ISL/community latrines where subsoil strata is not favorable (hard rock or low infiltration capacity)</li> <li>b. Construction of ISL/community latrines in water logged areas.</li> </ul>
<b>3) Storm water drains</b>		
<ul style="list-style-type: none"> <li>a. Construction of drains where groundwater table is greater than 3 m</li> <li>b. Subsoil is having sufficient bearing capacity</li> </ul>	<ul style="list-style-type: none"> <li>a. Construction of drains where groundwater table is at 2-3m below ground level</li> </ul>	<ul style="list-style-type: none"> <li>b. Construction of drains in water logged areas</li> </ul>
<b>4) Solid Waste Management</b>		
<ul style="list-style-type: none"> <li>a. Household biogas plant</li> <li>b. Household vermi composting plant</li> <li>c. Household aerobic composting plant</li> </ul>	<ul style="list-style-type: none"> <li>a. Household biogas plant</li> <li>b. Household vermi composting plant</li> <li>c. Household aerobic composting plant</li> </ul>	No Scheme

Annexure 20 -Environmental code of Practices for Water Supply and sanitation for Jalanidhi-2

S.No	Type of scheme	Issues	Mitigation Measures/ Environmental Code of practices
1	Water supply schemes	Damage to intake structures due to improper siting of source	<ul style="list-style-type: none"> <li>• Elimination of site having potential sources of contamination by conducting detailed sanitary survey as given in <b>Annexure 8</b></li> <li>• Source to be selected as per the guidelines given in <b>Annexure 9</b></li> <li>• Scientific investigations should be undertaken to ensure sustainable yield of source throughout the year.</li> <li>• CWRDM and the Dept. of Science, Technology and Environment of Government of Kerala should play a lead role in rendering technical assistance to the GPs (local bodies) in identifying and siting of aquifers of sustainable yield</li> <li>• Complete physico chemical analysis of source water has to be conducted and the source commissioned for supply only if the quality meets with the drinking water standards.</li> </ul>
		Reduction in yield of source: <b>SWSS</b>	<ul style="list-style-type: none"> <li>• Safe yield of the source should be ascertained by performing recuperation/pumping test as described in <b>Annexure 10</b>.</li> <li>• Construction of dug well/ bore well during the most critical period, such as towards end of summer.</li> <li>• Appropriate recharge measures to be implemented to ensure sustainability of yield of dug wells/ bore wells</li> <li>• Per capita water supply has to be decided based on the yield. Hence, the per capita supply should be flexible to match with the source yield subject to a minimum of 40 lpcd in summer months</li> <li>• Distribution system design will be done to ensure uniform supply of water without frequent valve operations</li> <li>• Roof catchment of rainwater in drought prone areas and remote/ isolated settlements.</li> <li>• Water development plan for each participating GP will identify the</li> </ul>

		<b>LWSS</b>	<p>relevant water recharge measures</p> <ul style="list-style-type: none"> <li>• Construction of check dams</li> <li>• Construction of storage reservoirs and Rain Water Harvesting (RWH) structures.</li> </ul>
		Sustainability of water source	<ul style="list-style-type: none"> <li>• Central Ground Water Board (Ground Water Resources of Kerala, 1997) has identified coastal alluvium in some parts of Thrissur, Malappuram and Calicut Districts, which can sustain filter point wells that are highly productive. Efforts should be made to identify such locations which could serve as sustainable sources of fresh water supply to the coastal Panchayats.</li> <li>• Appropriate legislation to be enforced to regulate ground water abstraction/ prevent water mining and minimize wasteful consumption.</li> </ul>
		Ground water depletion	<ul style="list-style-type: none"> <li>• Water conservation structures will improve the sustainability of the sources</li> <li>• Integrated water shed management at micro level to enhance ground water recharge, minimize soil erosion and promote green cover. This should receive high priority to achieve sustainability and perenniality of water supply sources.</li> <li>• Water shed management plan proposed for the project to be jointly prepared by Agriculture and Ground Water Departments, CWRDM and the local NGOs. The schemes include raised contour building, small check dams, reservoirs and rain water harvesting</li> </ul>
		Water logging	<ul style="list-style-type: none"> <li>• Construction of permanent non-submersible bunds at appropriate places</li> </ul>
		Water Quality: <b>Bacteriological</b>	<ul style="list-style-type: none"> <li>• Quality of water supplies in the state clearly indicates high level of bacterial contamination. Effective and continuous disinfection of all drinking water supplies so as to maintain minimum residual chlorine of 0.5 mg/l. A detailed description of disinfection method(s) is given in <b>Annexure 12.</b></li> </ul>

		<p><b>Salinity</b></p> <p><b>Fluoride</b></p> <p><b>Iron</b></p>	<ul style="list-style-type: none"> <li>• Sanitary protection of wells and springs will practically eliminate contamination from the surface through leaching of spill water and storm and agricultural runoff. The technical details of protection measures for wells and springs are given in <b>Annexure 13</b>.</li> <li>• Programmes related to hygiene education and awareness is essential to keep the area around the traditional water sources clean. These will be taken up under the health, sanitation and hygiene education component of the project, including safe handling of drinking water, disposal of waste water (sullage), personal hygiene, household hygiene and community environmental sanitation.</li> <li>• To cut down the entry of pollution to a minimum in a well, the recommended interventions are good parapet, good lining, good adequate drain and at least a nylon net cover.</li> <li>• For treating salinity, the project will have provision for Reverse Osmosis plant wherever required and demanded by the community.</li> <li>• Construction of weirs/ barrage/bunds across the river to prevent salt water intrusion.</li> <li>• Defluoridation technologies to be adopted in fluoride contaminated areas. Details of such technology are presented in <b>Annexure 14</b>.</li> <li>• Iron removal plants shall be installed in areas where water is affected by iron</li> <li>• Proper monitoring to be done to check the quality of water. Recommended monitoring plan is given in <b>Table 4.5</b>.</li> </ul>
2	Rehabilitation Schemes	Repairs to pumps, infiltration gallery, collection conveyance system and OHT. Excessive concentration of Iron & minerals due to corrosion in distribution pipelines	<ul style="list-style-type: none"> <li>• Allocation of adequate funds</li> <li>• Ensure availability of skilled manpower for rehabilitation works</li> <li>• Installation of PVC pipeline</li> </ul>

3	Rainwater harvesting Schemes	<p>Drying up of source during summer</p> <p>Damage to Rain Water Harvesting structures resulting in wastage of water during rainy season.</p> <p>Contamination of harvested rain water due to dust, leaves and bird droppings</p> <p>Taste and color in the harvested rain water</p>	<ul style="list-style-type: none"> <li>Guidelines for sustainability of ground water sources are given in <b>Annexure 11</b>. High rainfall in the state favors roof catchment of rain water especially in areas where there is acute scarcity of drinking water during summer months. The Government has also recommended RWH in Kerala Municipality Building (Amendment) Rules, 2004, which is discussed in Chapter II.</li> <li>Repair to Rain Water Harvesting structures, bunding at appropriate locations</li> <li>Periodically clean the catchment area and other parts of Rain Water Harvesting system</li> <li>Avoid metallic paint or other roof coatings as they impart taste and color to the collected water</li> </ul>
4	Environmental Sanitation	<p>Poor environmental sanitation, personal hygiene habits and lack of adequate supply of safe water</p> <p>Proximity of latrine pits and shallow wells on neighboring plots</p>	<ul style="list-style-type: none"> <li>Increasing the community coverage with sanitation facilities to achieve 100 % coverage in as short a time frame as possible.</li> <li>Selecting and installing safe sanitation technologies to suit the local soil characteristics and hydrogeology so as to minimize ground water contamination. Selection of safe sanitation technologies and environmental considerations in the location of toilets is given in <b>Annexure 15</b>.</li> <li>A minimum distance of 15 m, other than in fractured formations, between a pit and a downstream water-point, is normally sufficient to remove all contaminants. Recommended construction practices for Twin Pit Pour Flush Latrines are enclosed in <b>Annexure 16</b>.</li> <li>Low cost sanitation systems like pour flush single/two pit latrines, conventional septic tanks could be installed.</li> <li>Revamping the existing deep pit latrines (&gt;3m) to prevent direct contact of human excreta with the ground water. Depending upon site</li> </ul>



		Water logging and formation of pools of stagnant water during rainy season	<p>specific conditions, such latrines could be a source of potential risk to public health.</p> <ul style="list-style-type: none"> <li>• Improvement of drainage courses and the construction of new drainage channels to ensure effective drainage by channeling the flood flow.</li> </ul>
	Solid waste Management	Poor Solid Waste Management practice	<ul style="list-style-type: none"> <li>• Awareness must be created on solid waste segregation among the Beneficiary Group to process biodegradable waste into compost. The non biodegradables and the recyclables to be sold to recyclers. Batteries, Tube lights etc to be sent to hazardous waste landfill. These measures will prevent contamination of ground water</li> <li>• Training programmes in the area of Solid wastes Treatment, disposal, sanitation and drainage system for staff in the project agencies and communities to be organized</li> </ul>
	Liquid Waste Management	Poor Liquid waste disposal practice	<ul style="list-style-type: none"> <li>• In areas where population density is high, communal latrines connected to a biogas plant could be installed.</li> <li>• Wastewater generated from individual dwelling units can be treated through biodigester, water reeds and impervious storage pits. Capacity of bio digester is in the range of 1.2 m<sup>3</sup> to 1.5 m<sup>3</sup>. Detention time in the water reed beds would be around 7 days. Guidelines for Solid and Liquid waste management are presented in <b>Annexure 17</b>.</li> </ul>
5	All schemes	Financial Aspects	<ul style="list-style-type: none"> <li>• Operation &amp; Maintenance cost may be excluded for tribal community. These O &amp; M cost shall be borne by the Kerala Government under Social upliftment and programmes and welfare steps. Directorate of SC Development will have to initiate necessary action.</li> <li>• Power to change the terms of contribution may be considered to the village President in consultation with DPMU.</li> <li>• Inclusion of women in planning and decision making activities and also encouraging them to form "Thrift and Credit groups" to help them make payments towards recurring expenditure of water supply system</li> </ul>

**Annexure 21- LEA Format for Medium Impact Schemes**

a) GENERAL

S.No	Description	Particulars
1	Name of District	
2	Name of Block	
3	Name of Gram Panchayat	
4	Name of Habitation	
5	Population coverage	
6	Name of BG	
7	Name of the Project	
8	Duration of Project	

b) PROJECT DETAILS

1	<b>Project Objectives</b>	
2	<b>Project Components</b>	
3	<b>Resource Requirement</b>	
4	<b>Technology Used</b>	



<b>5</b>	<b>Environmental issues specific to the project</b>
<b>6</b>	<b>Mitigation measures</b>

c) ENVIRONMENTAL IMPACTS  
I. Land Environment

Expected Impacts	Mitigation Measures	Cost
Change in land use/ land cover/ topography		
Clearance of existing land		
Construction activities		
Demolition works		
Workers shed		
Facilities for storage of goods		
New road development		
Stream/ nala crossing		
Loss of top soil during construction		
Soil erosion due to project activities		
Alteration of natural drainage		



system		
Modification of wetlands/ low lying areas		
Waste generation		

**II. Air Environment**

Expected Impacts	Mitigation Measures	Cost
Generation of dust, smoke, fumes or Hazardous gases from project activities		
Increase in traffic noise due to project activities		
Vehicular dust		
Any other (specify)		

**III. Water Environment**

Expected Impacts	Mitigation Measures	Cost
Run off from construction activities leading to contamination of aquifers/ nearby water bodies		
Flooding of site due to rain		
Groundwater depletion		
Discharge of wastes		
Reduced availability of water		
Reduction in ground water recharge		
Any other (specify)		

**IV. Bio- Diversity**

Expected Impacts	Mitigation Measures	Cost
Clearing or modification of vegetation		
Threat to endangered species (flora & fauna)		
Obstruction to migratory path of birds		



Obstruction to natural breeding site of wild animals		
Invasion of alien species		
Any other		

V. Health and safety

Expected Impacts	Mitigation Measures	Cost
Domestic waste accumulation		
Bio- Medical waste accumulation		
Hazardous waste accumulation		
Inadequate maintenance of public toilets		
Accidents & Hazards		
Vector borne diseases		
Communicable diseases		
Inadequate sanitation		
Fugitive emissions		
Any other ( Specify)		

VI. Socio Economic Aspect

Expected Impacts	Mitigation Measures	Cost
Excessive noise near residential/ sensitive areas		
Bio- medical waste accumulation		
Threat to archaeological sites		
Inadequate maintenance of public toilets		
Inadequate sanitation		
Displacement of indigenous community		

Disturbance to sacred sites/ cultural values		
Any other ( Specify)		

**d) ANALYSIS OF ALTERNATIVES**

<b>Alternatives if any- (only if significant)</b>	<b>Environmental implications</b>	<b>Mitigation measures required</b>
1. 2. 3.		
Overall recommended mitigation plan		
Cost involved in implementing mitigation measures		
Prepared by  Name Designation Date Signature		

## Annexure 22- Model ToR for Conducting EIA for High Impact Schemes

### BACKGROUND

KRWSA, which is, today, an important player in the rural water supply and sanitation sector, has successfully developed a viable alternate model for service delivery based on the sound principle of cost recovery. Over the last ten years since its inception, this agency, which was constituted as a special purpose vehicle to implement Jalanidhi - a Rs.381 Crore World Bank aided Rural Water Supply and Sanitation Project, has acquired unique expertise in establishing rural water supply and sanitation projects based on the cardinal concepts of sector-reforms, namely, demand responsiveness, community ownership and sustainability of investments through cost recovery. The Jalanidhi project provides a central role to the Gram Panchayats in implementing community based water supply projects. KRWSA has also networked itself with a large pool of NGOs in accomplishing the challenging job of mobilizing communities and enabling them to have water supply and sanitation facilities owned and managed by themselves.

Kerala Rural Water Supply and Sanitation Agency has been promoting mainly Small water supply schemes and a few large surface based water supply schemes in the rural villages for the last 10 years. The project also give emphasis for the transfer of existing single Panchayat piped water supply schemes (currently owned and managed by Kerala Water Authority, KWA) to Gram Panchayats (GPs) and then to Beneficiary Groups (BGs) for the future operation and maintenance, as per the new Government of Kerala (GoK) policy. So far KRWSA has taken up 3696 small water supply schemes and 16 large surface based water supply schemes including Tsunami Rehabilitation Scheme under the Jalanidhi project.

Inspired by the success of this model GoK has decided to go on for a follow on project and accordingly submitted a proposal amounting to Rs.1200 Crores to Gol for approval. All time high target of 6720 small water supply scheme above apart from Joint venture large schemes through 224 Gram Panchayats together and to be completed by April 2016 in a progressive manner from 2010. Intra Gram Panchayat/Multi Gram Panchayat schemes are taken up under joint venture of KWA and KRWSA.

### OBJECTIVES OF THE STUDY

The objective of the study is to carry out Environmental Impact Assessment (EIA) for the proposed project to meet the environmental compliances laid down by the World Bank. Wherever necessary the compliance laid down by the State and Central Government shall also be met with. It will include detailed characterization of existing status of environment in an area of 10 km radial distance from the centre of the project site for various environmental components viz., air, noise, water, land, biological and socio-economic components including parameters of human interest.

The objectives of the present study are:

- To carry out EIA for the proposed project to meet the environmental compliances laid by World Bank.
- To establish the existing environmental settings of the project area based on information obtained from primary data and compilation of secondary

- data from published literature.
- To evaluate potential environmental impacts from the project during construction and operational phase and identify appropriate mitigation measures.
  - To prepare an effective Environment Management Plan for proper implementation and monitoring of mitigation measures.
  - To develop post study monitoring programme.

#### **MODEL ToR**

Project EIA is the stage when thorough assessments of project impacts and their mitigation are done. It includes carrying out detailed surveys, analysis of data, assessment of impacts and corresponding mitigation and/or enhancement measures, and preparing various reports that include the detailed EIA and EMPs. The Consultants shall carry out the project EIA based on the ToR which is the outcome of the project specific scoping process by modifying this ToR that is of generic nature suitably.

##### **a) Baseline Surveys**

The Consultants will

- i. Collect information from secondary sources that are relevant to understand the baseline, as well as design and mitigation of enhancement measures, as pertaining to physical, biological and socio-cultural environments,
- ii. Carry out site visits and investigations of all environmentally sensitive locations and document them on base maps to identify conflict point with preliminary designs (including verification of these from authentic sources of information, such as from revenue and forest records, etc.),
- iii. Prepare detailed specific maps showing details of sites for environmental enhancements.

##### **b) Additional Baseline Surveys**

The Consultants shall collect information on the existing environmental scenario from secondary sources, and identify gaps to be filled, relevant to the environmental screening needs from primary surveys. The Consultants shall survey the environmentally sensitive locations along the project site, as well as within the project influence area. The Consultants shall extensively use the video and other records of the study (carried out as part of engineering surveys). All regionally and nationally recognized environmental resources and features within the project's influence area shall be clearly identified and studied in relation to the activities proposed. Typically, these will include stretches with significant trees, environmental and common property resources such as forests, large water bodies, and major physical cultural properties. All these may be depicted using a line diagram or a strip map.

All surveys will be carried out in compliance with GoI standards / guidelines / norms. Wherever such guidelines / norms are unavailable, the techniques, tools and samples employed for the surveys shall conform to international practices. Whenever directly relevant secondary data is available, these should be used, while indirectly relevant data should be verified through primary survey. Environmental



quality (air, water, land and noise) monitoring shall include an adequate number of samples, as established on a sampling network, so as to provide a representative sample of the entire project corridor. Additional sample data for sensitive environmental/ecological receptors, if any, shall be collected such as to analyze and predict the possible impacts to a large degree and precision of acceptable professional standards. Further, additional specialized surveys, such as biodiversity assessment survey, and / or hydrological surveys shall be conducted, if and when recommended by environmental scoping. It is recommended that environmental surveys be co-ordinate with social and engineering surveys as far as practical.

The Consultants shall also collect information on the various prevailing environmental and forest laws / regulations so as to carry out the project EA in conformity with these laws and regulations.

**c) Stakeholder Consultation**

The Consultants shall undertake community consultation sessions at the State, District, Village and Community levels. The objective of these sessions shall be to improve the project's interventions with regard to environmental management. At least two rounds of consultations shall be carried out – the first to seek views from the stakeholders on environmental issues and ways that these could be resolved, and the second to provide feedback to stakeholders that their views have been taken into account for the project (when the EMPs are nearly complete). Following this the final feedback received shall be analyzed, and the Consultants shall determine how these shall be addressed in the Final EMP and project designs. The Consultants shall co-ordinate the entire consultation programme with social and engineering consultants.

**d) Environmental Analysis of Alternatives**

As the overall project alignments are final at this stage, the environmental analysis of alternatives shall focus on location-specific issues relating to cross-sections, materials and their sources from an environmental management perspective. This analysis shall also cover comparisons in relation to siting, design, technology selection, construction techniques and phasing, and operating and maintenance procedures.

**e) Impact Prediction and Management**

The Consultants shall determine the potential impacts due to the project through identification, analysis and evaluation on sensitive areas (natural habitats, sites of historic, cultural and conservation importance), urban settlements and villages / agricultural areas. These should be classified as significant positive and negative impacts, immediate and long-term impacts, and unavoidable and reversible impacts.

For each impact predicted, feasible and cost-effective mitigation measures shall be identified to reduce potentially significant adverse environmental impacts to acceptable levels. The capital and recurring costs of the measures, and the institutional training and monitoring requirements to effectively implement these measures shall be determined. The Consultants shall explore and recommend environmental enhancements including landscaping, separation of non-motorized lanes in an aesthetically appealing manner, provision of pilgrimage pathways, and development of cultural properties. At this stage, it would be important to identify issues that cannot be dealt with during the project preparation stage, but should be undertaken during the implementation stage.



**f) Institutional Arrangements to Manage Environmental Impacts Effectively**

The Consultants shall identify institutional and organizational needs to implement the recommendations of the project EA, and to propose steps to strengthen / expand them if needed. This may extend to new agency functions, inter-sectoral arrangements, management procedures and training, staffing, operation and maintenance, training and budgeting.

**g) Training of Staff**

The Consultants shall develop and implement a plan for training the client's staff. This plan must specify types of training, participants for each type, number of sessions, duration of each session and when they should be conducted. At the end of the training, when the draft EMPs are ready, brief reports shall be prepared on the training conducted and observations relevant for future training, if any.

**h) Other Assistance to be Provided by the Consultants**

The Consultants shall support the client to furnish any relevant information required for obtaining clearance from several State and Central Government agencies. These may include

- i. Assistance in the submission of application for clearance of reserved or protected forests to the Forest Department,
- ii. Completion of forms and submission of the same for obtaining No-Objection certificates (or NOCs) under the Water and Air Acts from SPCBs,
- iii. Completion and submission of the MoEF questionnaire for Environmental Appraisal of the project to obtain Environmental Clearance from MoEF/ SEIAA (if any),
- iv. Assistance in presentation to the Wildlife Board of the MoEF in obtaining Clearance for the scheme located near wildlife reserves or sanctuaries and other protected areas (if any),
- v. Assistance in submission of any other clearance requirements with regard to environmental components relevant to the project.

The Consultants shall discuss and co-ordinate with the engineering and social Consultants, the findings and recommendations of the project EA in a continuous manner. The Consultants shall then prepare an EAR, which will be revised in consideration of the comments of client and World Bank (if any).

**i) Environmental Management Plans**

Based on the predicted environmental impacts, separate EMPs, for each package, shall be prepared in such a manner that they can be incorporated in the bidding/contract documents. The EMP shall be prepared to fulfill all the requirements of the GoI, and at the minimum, shall meet the requirements of World Bank. The EMP shall also include a list of design modifications recommended by the project EA.

**j) Environmental Mitigation and Enhancement Measures**

The EMP shall describe feasible and cost-effective measures to prevent or reduce significant negative impacts to acceptable levels. Apart from mitigation of potential adverse impacts on environmental components, the EMP shall identify opportunities that exist for enhancement of environmental quality along the corridor. This shall include the enhancement of specific locations as water bodies, enhancement of scenic areas along the corridor, etc. residual impacts from environmental measures shall also be clearly identified. The EMP shall include specific or sample plans for construction-related activities, such as construction camps, and good practice guides related to construction and upkeep of plant and machinery. The EMP shall include detailed specification, bill of quantities, execution drawings and contracting procedures for execution of the environmental mitigation and enhancement measures suggested, separate for pre-construction, construction and operation periods. Responsibilities for execution and supervision of each of these mitigation and enhancement measures shall be specified in the EMP. A plan for continued consultation to be conducted during the implementation stage of the project shall also be prepared.

**k) Capacity Building and Training**

The EMP shall describe the implementation arrangement for the project, especially the capacity building proposals including the staffing of the environmental unit (as and when recommended) to implement the environmental mitigation and enhancement measures. For each staff position recommended to be created, detailed job responsibilities will be defined. Equipment and resources required for the environmental unit shall be specified, and bill of quantities be prepared. A training plan and schedule shall be prepared specifying the target groups (environmental unit, supervision consultants, and contractors) for individual training programmes, the content and mode of training.

**l) Monitoring and Reporting**

The EMP shall specify the environmental supervision, monitoring and auditing requirements. The monitoring programme shall specify parameters, reference standards, monitoring methods, frequency, duration, location, reporting responsibilities, and any other necessary inputs (e.g. training). In addition, the programme will specify what actions shall be taken and by whom in the event that the proposed mitigation measures fail, either partially or totally, to achieve the level of environmental protection expected. Customized formats for reporting on the progress of EMP activities to different stakeholders shall be prepared and included in the EMP.

Performance indicators with respect to water availability, water quality and sanitation shall also be included while conducting the monitoring.

Each EMP shall list all mandatory government clearance conditions and the status of procuring the clearances. Additionally, the EMPs shall include as separate attachments, if applicable, Natural Habitat Plan and / or Cultural Properties Plan, etc. to satisfy the requirements of World Bank's operational policies.

Each EMP shall provide a summary description of where and how the recommendations of EA and EMP are made part of the project's design, construction schedule, and all contract documents.

**m) Environmental Budget**

The implementation of the pollution control, environmental monitoring and management programmes are the basis for mitigation of impacts. Though the schemes in Jalanidhi- 2 have to be implemented successfully, the environment also has to be preserved for future generations. The environmental expenditures show commitment of the management on environmental front. The budgetary cost estimate for greenbelt development, environmental monitoring, training & mobilization and groundwater recharge, risk mitigation measures and occupational health & safety are to be included in the environmental budget.

### Annexure 23- Proceedings of the Public Consultation Programme

The Public Consultation Programme on Environmental Impact Assessment, Environmental Management Framework and Tribal Development Plan for the proposed Jalanidhi phase II held on 14.06.2011, 10.30AM at Institution of Engineers Hall, Trivandrum.

In the consultation programme 49 persons from various organizations and NGO's participated and the list of participants are attached below.

At the onset, Shri Sukumaran Nair, Director Hydrogeology, KRWSA welcomed the participants. He explained briefly about Jalanidhi I, its singularity and remarked that Jalanidhi II is launched considering the lessons learnt from Jalanidhi1. As a part of launching Jalanidhi II, studies on EIA, EMF & TDP were conducted. The reports need refinement with suggestions and modifications from the public, which is the reason for arranging this consultation workshop

**Shri.N.Prasanth, IAS Executive Director, KRWSA**, inaugurated the consultation programme. In his inaugural address he explained that this is a mandatory consultation process for implementing the Jalanidhi -2 schemes and KRWSA requires feedback from the Govt organizations, NGO's and individuals concerned with water sector and also from those concerned with the improvement of tribal sector. He remarked that Jalanidhi is not a large project but a project with only small water supply schemes. Since every human interaction has some environmental impacts, we should foresee this before starting the project and act accordingly with all the required safeguards necessary for combating the likely adverse environmental impacts upon implementation of the project

The inauguration was followed by a presentation by Shri .S.Rathish, Director (Operations) on the experiences, success and lessons learned from Jalanidhi1 and the corresponding modified strategy adopted for Jalanidhi2. The important components of Jalanidhi2 and the proposed changes in the technical and administrative set up for Jalanidhi2 right from project planning to final completion were also presented.

Shri. M. Premal, Director (HRD) made a presentation on Tribal Development Programme to be adopted in Jalanidhi2. He explained that Jalanidhi aims at providing safe and pure water to the poorest of the poor based on a demand driven approach. The beneficiaries have to bear a share of capital cost and total O&M cost. Though many plans and programs exist for safeguarding the interest of the Tribals, many do not reach them considering their socio-economic – political backwardness. So a special plan for Tribal community is necessary. He explained the features of the plan, scheme cycle, governing mechanism etc.

Next presentation was by Dr Jayaseelan of M/s ABC Environ Solutions Chennai on the Environmental Management Framework to be adopted in Jalanidhi. It was based on a study assigned to them. Briefing the background of the study, the consultants explained the objectives, components, types of schemes going to be implemented, and the results of their study with the probable Environmental impacts to be addressed during post and pre implementation period of Jalanidhi2. The GPs selected for the EIA & EMF study, secondary data collection details; approach and methodology of the study etc. were explained by Dr Jayaseelan. The problems identified from the study & the mitigation



measures were discussed. Based on the detailed assessment made, the consultants explained the Environment Management framework developed for the Jalanidhi2. The core of the EMF is classification of the schemes into Low impact, Medium impact & High impact schemes for adoption of suitable remedial measures and the environmental management interventions for such schemes were also explained. He outlined the criteria proposed for the above classification. The responsibility of each of the officers concerned, need for various trainings, etc were also elaborated by the consultants. Dr R. Paramasivam from ABC Environs also contributed significantly during the interactions and discussions

Following the presentations, detailed discussions were held on the EA & EMF and TDP. Majority of the issues raised by participants were related to water security, drainage, RWH and sanitation. **Various dignitaries present in the workshop interacted on the relevant subject concerned with them and KRWSA officials responded with due importance. The important points raised and the explanations from the KRWSA /consultants are given below**

**Mr.M.N.Prasad, Rtd, Chairman Railway Board**

1. To ensure that, water provided to each HH is potable without boiling it.  
Design of the system will ensure provision for effective disinfection.
2. Use of a source already existing in higher elevation  
Such system like springs will be preferred considering the various inherent advantage of such a system. During implementation of the scheme such sources will be identified and proper protection will be provided to these systems, with effective disinfection and other treatment if required.
3. Reservoirs help in recharging than providing check dams.  
In the water security plan, based on techno economic feasibility, watershed management will be practiced.
4. Providing water quality testing facilities, at GP level.  
The provision has already been made in Jalanidhi -2, to set up water quality testing facilities for GPs at Higher Secondary Schools.
5. Registry of experts in water supply & sanitation in GPs.  
Registry of experts has to be maintained and made available to BGs as and when they need expert opinion, to make their choice.
6. Budget provisions for cleaning of storm water drains to be made.  
Well established design procedures will be followed to ensure functionality of the System and the beneficiaries will be motivated to take care of the maintenance.
7. Less of politics and more of work to be implemented in BG.  
Proper co-ordination with political groups will be ascertained for sustainable functioning of the system

**Dr.CSP Iyer, IITMK.**

8. There should be no compromise in quality.  
Proper disinfection and appropriate treatment will be provided in all the schemes.
9. Management of water quality testing laboratories in school to be taken up.  
Proper training will be provided to the concerned staff regarding water quality testing and quality of the reports generated by them will be monitored in an effective manner



10. Educating the community has to be taken care of.  
Education to the community, through IEC, and HRD activities to impart knowledge, on all the important aspects of the scheme should precede the selection of BGs. During the implementation also IEC AND HRD activities will be taken up to ensure capacitating the community to take up the scheme in an effective manner
11. Uninterrupted water supply has to be provided.  
Wastage and over consumption will be discouraged to ensure water security in terms of quantity, quality and reliability of supply as per the approved design
12. O &M aspects have to be taken into account.  
Entire responsibility of O &M lies with BG and the technical aspects regarding O &M can be addressed by RPMU and all those aspects will be included in the IEC activities

**Ms. Sindhu, Asst. Professor, College of Engg. Trivandrum**

13. Sanitation has to be given equal importance as that of RWS.  
Since the project is demand driven, the demand of BG will be taken into account and sanitation components will be provided accordingly.
14. Study on Jalanidhi-1 to be conducted to assess its performance.  
Study was conducted by State Planning Board and IIM Kozhikode apart from KRWSA. However additional studies can be organized through some independent agencies for Jalanidhi in future also

**Dr. Nandakumar, Regional Director, CGWB**

15. Interference of water supply sources should be prevented.
16. Water security plan will address it. Pumping test will be conducted in each and every source and pump specification is decided based on safe yield. Ground water regulations will be taken care of and distribution will be done in equity, giving priority for drinking. IEC will be provided to BGs to avoid conflict.
17. In tribal areas, water availability is less and O& M is difficult to manage.  
In hilly areas, water shed management has to be ensured to supply adequate water. Problems associated with O&M will be addressed through RPMU/SO.
18. In hilly areas, the existing source/ system shall be strengthened, instead of providing a new source.  
Maximum efforts will be made to utilize traditional existing source /system. But existing system can be strengthened only after ensuring that the yield of source is adequate to meet the increasing demand of the community.

**Dr. P.K. Thambi, Rtd. Scientist, CESS**

19. In Jalanidhi-1, while identifying source for RWS, hydrogeological support was not sufficient.  
Efforts are made to obtain more hydro geological inputs in Jalanidhi-II by creating a post of Hydrogeologist in each RPMU. While preparing water security plan, necessary input from hydrogeologists will be extended and all hydrogeological aspects will be taken care in water security plan.
20. Impact due to smaller schemes has to be given importance.  
All the schemes irrespective of whether large or small will be addressed for environmental impacts.

21. Recommendation for recharge of upper catchment source was given in Jalanidhi-1 and was not taken care of.  
Coordination has to be maintained among the parties and issues arising shall be attempted to be resolved through IEC and through involvement of concerned parties.
22. Subsurface recharge can be suggested in hilly areas.  
Based on techno economic feasibility, appropriate recharge measures will be suggested in water security plan.
23. Withdrawal of water increases, when more people enter into the scheme after implementation.  
Before extending the service coverage, the yield from the source has to be ensured and technical feasibility carried out for which necessary guidelines will be given to the BGs.

**Sri John Mathai, Scientist F.CESS**

24. Feasibility of developing RWH system in thatched roof has to be explored.  
RWH system will be introduced irrespective of HH type based on techno economic feasibility.
25. LWSS has to be implemented only if it is inevitable and should prefer SWSS to a greater extent.  
Water supply scheme will be selected based on the water security plan and demand of BG.

Generally all the participants unanimously opined that EA study conducted was effective in addressing all the key issues. It outlined all the important impacts and the possible mitigation measures. The practical approach of the same has to be given due importance during implementation of the project.

**Deliberations regarding the Tribal Development Plan.**

**Shri.Moosa, District Tribal Development Office, Kalpatta, Wayanadu.**

Beneficiary groups find it very difficult to raise the required funds for the O & M expenses for the Tribal Schemes. They are not even bothered to collect the recurring expenditure fund from the users and if collected they will not account it properly. They are unaware of social responsibility or accountability in maintaining a group asset.

He suggested KRWSA shall take up the matter with LSG Department to get the required funds for O& M from plan allocations or own revenue. He also suggested getting the required fund for O & M from the TSP funds from Tribal Development Department.

Simplified technology options will be adopted in tribal areas. This will ensure minimum O & M expenses for the schemes. The possibility of getting funds for the O & M can be examined by the GP on case to case. The suggestions of the participant will be taken care of and will be discussed with the LSG or Tribal Department.

**Mr.Pramod, Tribal re-settlement mission, Wayandu.**

He also opined that collection of beneficiary share towards the capital contribution is very difficult, even if it is 1 % cash, they will not contribute. He suggested that KRWSA may avoid the beneficiary share and give the scheme free. He also suggested examining the possibility of getting the funds for the recurring expenses from the TSP funds.



From the experience of Jalanidhi- phase 1 the tribals had contributed 83.6 lakhs altogether. In the proposed project to ensure more inclusion of vulnerable groups, the beneficiary contribution towards capital cost has been reduced to 5 % (1% cash and 4 % labour). The TDP plan also envisage the cross subsidization by the economically sound BG members or any social organisation or even GP can also contribute.

**Mr.Udayabhanu, Project co-ordinator, ASSO, Palakkad.**

He pointed out that he has worked in all batches of Jalanidhi 1 and from his experience, the collection of beneficiary contribution is not at all an issue. Proper IEC will ensure the willingness to pay. If we can provide the service at the door step the beneficiaries will pay. Few house holds may have the difficulty in raising the contribution even if it is only 1% cash, this can be ensured by the cross subsidization. He also emphasized the need for water metering to ensure scientific water management.

**Mr. Shalimon, Project Officer, SEUF.**

He also opined that collection of beneficiary contribution in tribal area is not at all difficult, but after the exit of the schemes the beneficiary group has facing lot of difficulty in raising the required O & M expenses.

He opined that when planning the scheme simplified technology option such as gravity schemes will be planned, this will reduce the investment cost and as well as the recurring expenses. He suggested avoiding complex pumping schemes to make the schemes user friendly. Spring flows in the tribal areas will be assessed during the summer season to measure the perennial nature.

Sanitation is the main issue in the tribal area; they do not use the toilets and still practicing the open defecation. The behaviour change is key issue.

This can be addressed by the special IEC programmes planned for the second Jalanidhi. IEC can be made effective through using their local aids and mediums.

He also emphasized the need for Hydrogeological/ Technical support mechanism at the district level to ensure sustainability of systems and sources.

He enquired whether there is any flexibility for the project implementation in case of components and time.

**O.P.Abraham, Programme Officer, WSSO, Wayandu.**

He enquired about the latrine subsidy. And also whether the project will stipulate any condition for allotting the toilets to the tribals. During phase I implementation there was a condition for sanctioning the individual toilets. If any house holds receives any grant for construction of toilet for the past 5 years and not constructed the toilet will not eligible at that time. This will be a main hindrance in achieving the target.

In the new Jalanidhi Project there is no such condition for granting toilets.

He also opined that the O & M collection is very difficult for the BGs. He suggested that this can be liberalized by sharing the O & M cost by BG and GP equally.

He pointed out the two tribal communities; Adiya and Kattunaickan are not listed in the proposed tribal plan.

This mistake will be rectified during the revision of tribal plan.

He also pointed out the insurance for the schemes had failed during the implementation phase 1, insurance companies are not interested to cover the tribal schemes, as it is in very remote locations. He suggested that this time KRWSA will ensure proper mechanism to address this issue.

This will be taken care of during the implementation of the Jalanidhi 2.

**Dr.C S P Iyer, IITMK.**

When implementing the tribal schemes proper IEC will be given.

**Dr.Nandakumar, Regional Director, CGWB**

When planning for the tribal schemes simple technology options may be considered. Primary task will be to rejuvenate the traditional sources. This will ensure the sustainability of the schemes. When planning a water supply scheme using spring source the potential of the source may be assessed during the summer in a scientific way. Traditional knowledge will also be considered for the development sources.

Sri.P.Nandan, Consultant (M&E) expressed thanks to all participants, officials NGO's for taking part in a healthy discussion and making the programme a grand success.



**PUBLIC CONSULTATION**

**Annexure 24- Query rose during Public Consultation and the  
reply addressed in Subsequent pages of the Report**

S.No	Query	Reply addressed in page
1	To ensure water provided to each HH is potable without boiling.	Disinfection of water page 271, Annexure- 12
2	Use of already existing source in higher elevation.	Sanitary protection of wells & springs , page 279, Annexure-13 Guidelines for sustainability of groundwater sources page 267
3	Reservoirs help in recharging than check dams.	Discussed in Environmental codes of practices for water supply & sanitation in Jalanidhi-2, Page 323, Annexure-20
4	Providing water quality testing facilities at GP level.	Environmental Supervision, Monitoring and Evaluation Plan, page no 91 & 109
5	Educating the community has to be taken care of.	Training for Environmental Management, Page 94
6	Uninterrupted water supply to be provided.	Guidelines for selection of water supply sources, page 263, Recuperation test for estimation of yield of well page 265, Guidelines for sustainability of groundwater sources page 267
7	Registry of experts in water supply & Sanitation in GPs.	Not under our scope. This can be maintained and made available to BGs.
8	Budget provisions for cleaning of storm water drains to be made.	Storm water drainage is one of the components of the scheme and addressed in safe disposal of liquid waste, page 5 & 107. Budget provisions have to be made in the project cost.
9	Less of politics and more of work to be implemented in BG.	Not addressed as it is not related to EMF.
10	O & M aspects have to be taken into account.	O& M is one of the components of the scheme and addressed in page 5
11	Sanitation has to be given equal importance as that of RWS.	Sanitation is one of the components of the scheme and detailed in pages 4 & 104.
12	Study on Jalanidhi-1 to be conducted to assess its performance.	Lessons learnt from Jalanidhi-1 and to be reflected in Jalanidhi-2 are addressed in pages 2 & 3
13	Interference of water supply sources should be prevented.	Guidelines for selection of water supply sources, page 263, Recuperation test for estimation of yield of well page 265, Guidelines for sustainability of groundwater sources page 267

		IEC will avoid conflict in BGs and addressed in Training & capacity building, page 93
14	In tribal areas, water availability is less and O& M is difficult to manage.	Discussed in Environmental code of practices for water supply & sanitation in Jalanidhi-2, page 322. O & M is one of the components of the scheme and addressed in page 5
15	In hilly areas, the existing source/ system shall be strengthened, instead of providing a new source.	Sanitary protection of wells & springs , page 279, Annexure-13 Guidelines for sustainability of groundwater sources page 267 Environmental code of practices for water supply & sanitation in Jalanidhi-2, page 322
16	In Jalanidhi-1, while identifying source for RWS, hydrogeological support was not sufficient.	Addressed in water development plans, page-5 Environmental code of practices for water supply & sanitation in Jalanidhi-2, page 322
17	Impact due to smaller schemes has to be given importance.	Addressed in Environmental code of practices for water supply & sanitation in Jalanidhi-2, page 322
18	Recommendation for recharge of upper catchment source was given in Jalanidhi-1, and was not taken care of.	Addressed in water development plans, page-5 Issues shall be resolved through IEC and addressed in Training & capacity building page 93
19	Subsurface recharge can be suggested in hilly areas.	Addressed in Environmental code of practices for water supply & sanitation in Jalanidhi-2, page 322
20	Withdrawal of water increases, when more people enter into the scheme after implementation.	Guidelines for selection of water supply sources, page 263, Recuperation test for estimation of yield of well page 265, Guidelines for sustainability of groundwater sources page 267
21	LWSS has to be implemented only if it is inevitable and should prefer SWSS to a greater extent.	The scheme will be selected based on water security plan addressed in page 5 and demand of BG Environmental code of practices for water supply & sanitation in Jalanidhi-2, page 322

### BIBLIOGRAPHY

1. Abhilash Babu (2009), 'Governmentality, Active Citizenship and Marginalisation: The Case of Rural Drinking Water supply in Kerala, India', Asian Social Science, Vol.5, No. 11.
2. 'An Evaluation Study of Jalanidhi Projects in Kerala' (2009), Evaluation Division Kerala State Planning Board, Thiruvananthapuram.
3. APHA (2005), 'Standard Methods for the Examination of Water and Wastewater', Washington, D C, American Public Health Association.
4. A.Ramachandran, B.Enserink and A.N.Balchand (2005), 'Coastal Regulation Zone Rules in Coastal Panchayats (Villages) of Kerala, India – Socio Economic Impacts from the Recently Introduced Peoples Participatory Program for Local Self Governance and Sustainable Development', Ocean & Coastal Management, Vol. 48, pp 632–653.
5. B.C.Punmia, Ashok Kumar Jain, Arun Kumar Jain (2005), 'Soil Mechanics and Foundation', Sixteenth Edition, Laxmi Publications (P) Ltd., pp 210 – 217.
6. Central Ground Water Board, India - <http://cgwb.gov.in>
7. 'Coastal Regulation Zone Notification' (2010), Published in the Gazette of India, Ministry of Environment and Forests.
8. 'Community-Managed Sanitation in Kerala, India: Tools to Promote Governance and Improve Health' (2010), Social Accountability Notes, World Bank Institute.
9. 'District Handbooks of Kerala, Palakkad' (2003), Department of Information and Public Relations Government of Kerala.
10. 'District Handbooks of Kerala, Thiruvananthapuram' (2004), Department of Information and Public Relations Government of Kerala.
11. 'District Handbooks of Kerala, Wayanad' (2003), Department of Information and Public Relations Government of Kerala.
12. 'Drinking Water Quality in Rural India: Issues and Approaches', Water Aid, <http://www.wateraid.org/>.
13. Dr.P.V.Ramachandran and Dr.V.Mohanan Nair (2002), 'The Endosulphan Controversy in Padre Village, Kasargod, Kerala', Report of the IMA team submitted to Kerala State Branch of Indian Medical Association.
14. Dr. R. Ajayakumar Varma, 'Status of Municipal Solid Waste Generation in Kerala and their Characteristics', NEERI.
15. Dr.R.Paramasivam (2000), 'Environmental Analysis Report for Kerala Rural Water Supply and Sanitation project', prepared for The World Bank and KRWSSA.
16. Dr. Sainudeen Pattazhy, 'Problem of Solid Waste Management'.
17. Dr.S.C.Dhiman and D.S. Thambi, 'Ground Water Management in Coastal Areas'.
18. Dr. S. Jeyavelu & Dr. Saji Gopinath (2008), 'Jalanidhi: Success through Participation', Indian Institute of Management, Kozhikode.

19. 'Dynamic Ground Water Resources of Kerala' (2004), Ground Water Department, Government of Kerala and Central ground Water Board, Government of India.
20. 'Economic Review' (2003), State Planning Board, Trivandrum, Government of Kerala.
21. 'Economic Review' (2009), State Planning Board, Trivandrum, Government of Kerala.
22. 'Environmental Analysis and Environmental Management Framework Report (2008)', prepared for the World Bank and Rural Water Supply and Sanitation Department, Government of Andhrapradesh.
23. 'Environmental Impact Notification' (2006), Published in the Gazette of India, Ministry of Environment and Forests.
24. 'Final Report on Sector Environmental Assessment' (2006), Prepared for Department of Water Supply & Sanitation (DWSS), Punjab.
25. Gregory D. Jennings (1996), 'Protecting Water Supply Springs', Water Quality and Waste Management, Published by: North Carolina Cooperative Extension Service.
26. 'Ground Water Information Booklet of Alappuzha District', Kerala State (2007), Central Ground Water Board, Government of India.
27. 'Ground Water Information Booklet of Ernakulam District', Kerala State (2007), Central Ground Water Board, Government of India.
28. 'Ground Water Information Booklet of Kasargod District', Kerala State (2007), Central Ground Water Board, Government of India.
29. 'Ground Water Information Booklet of Kollam District', Kerala State (2007), Central Ground Water Board, Government of India.
30. 'Ground Water Information Booklet of Kottayam District', Kerala State (2007), Central Ground Water Board, Government of India.
31. 'Ground Water Information Booklet of Kozhikode District', Kerala State (2007), Central Ground Water Board, Government of India.
32. 'Ground Water Information Booklet of Malappuram District', Kerala State (2007), Central Ground Water Board, Government of India.
33. 'Ground Water Information Booklet of Thrissur District', Kerala State, (2007), Central Ground Water Board, Government of India.
34. 'Ground Water Information Booklet of Wayanad District', Kerala State (2007), Central Ground Water Board, Government of India.
35. 'Ground Water Year Book of Kerala' (2008 - 2009), Central ground Water Board, Ministry of Water Resources, Government of India.
36. 'Guide on Artificial Recharge to Ground Water' (2000), Ministry of Water Resources, Central Ground Water Board.

37. Harikumar.P.S. (2009), 'Water Quality Status of Kerala with Special Reference to Drinking Water', Proceedings of Kerala Environment Congress, Thiruvananthapuram.
38. 'Health Hazards of Aerial Spraying of Endosulphan in Kasargod District, Kerala' (2003), Report of the Expert Committee, Government of Kerala.
39. IS (1991), Bureau of Indian Standards: Drinking Water Specifications, 10500-1991.
40. Jalanidhi - <http://www.jalanidhi.kerala.gov.in>
41. Kerala State Council for Science, Technology and Environment - Official Website - <http://www.kscste.kerala.gov.in/>
42. Kerala Water Authority, Kerala - Official Website <http://www.kwa.kerala.gov.in/>
43. K.R.Nisha (2005), 'Institutional Arrangements in Rural Water Supply in Kerala: Constraints and Possibilities', Drinking Water Session of the 4<sup>th</sup> IWMI - TATA Annual Partners Meet, Institute of Rural Management, Gujarat.
44. 'Local Governments and User Groups Plan and Implement Large Water Supply Schemes'(2008), Field Note, Water and Sanitation program.
45. Modified Guidelines for Solid Waste Treatment Treatment Plants to be set up by Local Government (2011), Local Self Government Department, Thiruvananthapuram.
46. Ministry of Rural Development, India <http://rural.nic.in>
47. Ministry of Water Resources, India <http://www.wrmin.nic.in/>
48. M.K.P.Roy (2004), 'Water Quality and Health Status in Kollam municipality', Discussion Paper No. 56, Kerala Research Programme on Local Level Development, Centre for Development Studies, Thiruvananthapuram.
49. 'Municipal Solid Wastes (Management and Handling) Rules' (2000), Published in the Gazette of India, Ministry of Environment and Forests.
50. 'National Rural Drinking Water Programme - Movement towards Ensuring People's Drinking Water Security in Rural India' (2010), RGNDWM, Ministry of Rural Development, Government of India.
51. 'Panchayat Level Statistics, Ernakulam District' (2001), Department of Economics & Statistics, Kerala.
52. 'Panchayat Level Statistics, Kannur District' (2001), Department of Economics & Statistics, Kerala.
53. Panchayat Level Statistics, Kasargod District' (2001), Department of Economics & Statistics, Kerala.
54. 'Panchayat Level Statistics, Kollam District' (2001), Department of Economics & Statistics, Kerala.
55. 'Panchayat Level Statistics, Kozhikode District' (2001), Department of Economics & Statistics, Kerala.

56. 'Panchayat Level Statistics, Malappuram District' (2001), Department of Economics & Statistics, Kerala.
57. Panchayat Level Statistics, Palakkad District' (2001), Department of Economics & Statistics, Kerala.
58. Panchayat Level Statistics, Thrissur District' (2001), Department of Economics & Statistics, Kerala.
59. Policy Brief (2007) 'Facing Hazards at Work- Agricultural Workers and Pesticide Exposure in Kuttanad, Kerala', South Asian Network for Development and Environmental Economics, No. 19 – 07.
60. Rain Water Harvesting Techniques to Augment Rain Water (2003), Ministry of Water Resources, Central Ground Water Board.
61. 'Report of the Working Group on Water Resources and Environment-Approach, Policies and Reforms' (2003), Tenth Five Year Plan 2002-07, State Planning Board, Thiruvananthapuram.
62. 'Report on Visit to Vembanad, Kerala, a Wetland included under National Wetland Conservation and Management Programme of the Ministry of Environment and Forests' (2008), Planning Commission, Government of India.
63. Rural Development Department, Government of Kerala - Official Website - <http://www.crd.kerala.gov.in/>
64. 'State of Environment Report Kerala' (2005), Kerala State Council for Science, Technology and Environment, Government of Kerala.
65. 'Status of Environment and the Related Issues' (2007), ENVIS Kerala, Vol.1, No.1, Quarterly News Letter.
66. 'Status of Environment and the Related Issues' (2009), ENVIS Kerala, Vol.3, No.4, Quarterly News Letter.
67. Suchitwa Mission – Official Website – <http://www.sanitation.kerala.gov.in>.
68. 'The Environment (Protection) Rules' (1986), Published in the Gazette of India, Ministry of Environment and Forests.
69. 'The Wildlife (Protection) Act (1972)', Published in the Gazette of India, Ministry of Environment and Forests.
70. Tomas Blom and Edir Cederlund (2006), 'Fluoride Contaminated Ground Water in Palakkad and Alappuzha Districts of Kerala, South India - Chemical Characteristics and Mechanisms of Mobilization- A Minor Field Study', Master Thesis 06-09, KTH Royal Institute of Technology, Stockholm.
71. 'Water and Air quality Directory' (2009), Kerala State Pollution Control Board, Thiruvananthapuram.
72. 'Water Treatment-Chlorination', <http://www.watersanitationhygiene.org/>



**STUDY TEAM**

ABC Environ Solutions Pvt. Ltd. carried out this EA & EMF for Jalanidhi-2. The multidisciplinary team included expertise in rural water supply, Environmental Impact Assessment, water supply & sanitation Engineering, Ecology and bio-diversity, monitoring, Land use, Geology, and Socio-Economic Expert.

The team members were:

Name	Role
Dr.R.Paramasivam	Team Leader
Dr.R.K.Jayaseelan	Principal Consultant-Water supply & Sanitation Engineering Specialist
Dr. S. Thillaigovindarajan	Consultant – Hydrogeologist
Dr.Remasaraswathy	Socio Economic Expert
Ms.Ramaa Prakash	General Manager (Technical) -Site selection, Environmental Legislation, Report Preparation, Finalization & Coordination with client
Mr.Ravi Selvaraj	General Manager(Projects) – Baseline studies & Quality control of Analysis reports
Mr. A.Robson Chinnadurai	Senior Chemist -Environmental Monitoring and Lab testing Expert
Ms.Sathya.S	Project Coordinator - Report Analysis and preparation, Focused Group Discussion.
Mr.D.S.Sivaraaj	Regional Manager- Focused Group Discussion
Mr. J. Raja Ganapathy	Project Engineer – Focused Group Discussion
Mr. A.Maignanamurrti	Project Engineer - Focused Group Discussion
Ms.S.P.Ilakkiya Selvi	Project Engineer – Report preparation, Environmental Management Framework
Ms.K.Parvathy	Project Engineer at Site- Focused Group Discussion, Coordination with Client
Mr.Shafeer Babu	Project Engineer - Focused Group Discussion
Mr. M.Sathyamoorthy	Field Technician & Environmental Chemist



**Jalanidhi**  
KERALA RURAL WATER SUPPLY & SANITATION AGENCY



Save Nature for Future